

VON DUPRIN®

Price book 14

Effective March 1, 2024

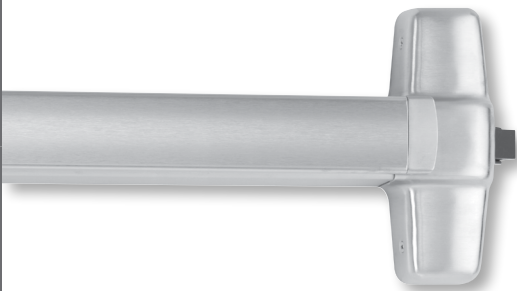
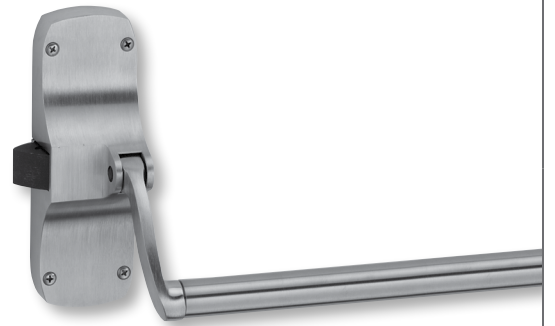

United States Customer Care

Our Customer Care Representatives are available for questions or assistance.

877-671-7011

Customer service

- ☎ Press **1**
- ✉ Support@allegion.com

Technical support

- ☎ Press **2**
- ✉ Exits_TechProdSupport@allegion.com

For new projects or to locate an authorized distributor

- ☎ Press **3**

Placing orders

You can place orders with Allegion via the fax number or email listed below:

- ☎ 1-800-999-0328
- ✉ Allegion_Orders@allegion.com

Engineering special product quotes

- ☎ 1-877-730-6248
- ✉ VDI_Specials@allegion.com

United States Administrative Office

11819 N. Pennsylvania Street
Carmel, IN 46032
allegion.com/us

Canada Customer Care

Our Customer Care Representatives are available for questions or assistance.

- ☎ 800-900-4734
- ✉ Canada.CustomerService@allegion.com

Technical product support

- ✉ Canada.TechServices@allegion.com

Placing orders

You can place orders with Allegion via the fax number or email listed below:

- ☎ 1-800-209-4734
- ✉ Canada.Orders.Service@allegion.com

Canada Administrative Office

1076 Lakeshore Road East
East Mississauga, Ontario L5E 1E4
allegion.ca

United States Request for quote

Carolinas

(North Carolina, South Carolina, Virginia)
Carolinas.Quotes@allegion.com

Central

(Illinois, Iowa, Kansas, Missouri, Nebraska)
Central.Quotes@allegion.com

Chicago

(Northern Illinois, Wisconsin)
Chicago.Quotes@allegion.com

Florida

Florida.Quotes@allegion.com

Metro New York

(Metro New York, Northern New Jersey)
Metro.Quotes@allegion.com

Michigan

Michigan.Quotes@allegion.com

Mid Atlantic North

(New York, Western Pennsylvania)
Mid.Atlantic.North.Quotes@allegion.com

Mid Atlantic South

(Delaware, Eastern Pennsylvania, Maryland, Northern Virginia, Southern New Jersey, Washington DC)
Mid.Atlantic.South.Quotes@allegion.com

Midwest

(Indiana, Kentucky, Ohio, West Virginia)
Midwest.Quotes@allegion.com

Mountain States

(Colorado, Idaho, Montana, Nevada, Utah, Wyoming)
Mtn.States.Quotes@allegion.com

New England

(Connecticut, Maine, Massachusetts, New Hampshire, Rhode Island, Vermont)
NewEngland.Quotes@allegion.com

North Central

(Minnesota, North Dakota, South Dakota)
NorthCentral.Quotes@allegion.com

Northern California

NoCal.Quotes@allegion.com

Northwest

(Alaska, Oregon, Washington)
Northwest.Quotes@allegion.com

South

(Alabama, Georgia, Louisiana, Mississippi, Tennessee)
South.Quotes@allegion.com

Southern California

(Southern California, Hawaii)
SoCal.Quotes@allegion.com

Southwest

(Arizona, New Mexico)
Southwest.Quotes@allegion.com

Texas

(Arkansas, Texas, Oklahoma)
Texas.Quotes@allegion.com

Canada Request for quote

(All Regions/Provinces)
Quote.Request.Canada@allegion.com

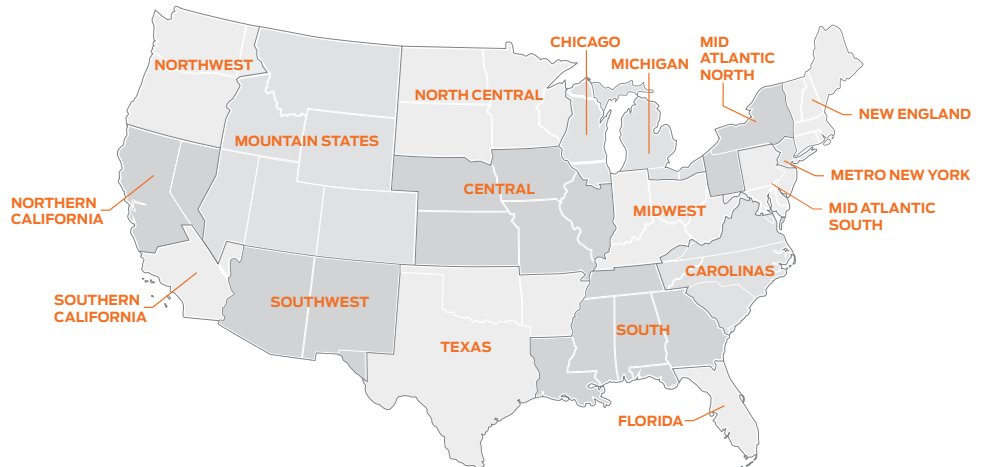

Contents

Doing business with Allegion	5	98/99 Series	82
About the Allegion Catalog Nomenclature (ACNs)	6	98/99 Series Overview	82
Styles	7	98/99 Series Configure a product	87
General information	11	Rim devices	87
How to order	12	Surface vertical rod devices (27)	88
Special order products	13	Concealed vertical rod devices (47)	89
Mortise lock order form	14	Wood Door Concealed vertical rod devices (47-WDC)	90
Exit devices	19	Concealed vertical rod devices (48)	92
22 Series	20	Surface three point latch devices (57)	93
22 Series Overview	20	Mortise lock devices (75)	94
22 Series Configure a product	23	Concealed vertical cable devices (49)	95
Rim devices	23	Wood Door Concealed vertical cable devices (50-WDC)	96
Surface vertical rod devices (27A)	24	Pool exit hardware (52)	97
Options	25	Options	98
Kits	26	Kits	103
Parts and accessories	27	Parts and accessories	107
33A/35A Series	29	XP98/XP99 Series	117
33A/35A Series Overview	29	XP98/XP99 Series Overview	117
33A/35A Series Configure a product	34	XP98/XP99 Series Configure a product	121
Rim devices	34	Rim devices	121
Surface vertical rod devices (27A)	35	Options	122
Concealed vertical rod devices (47A)	36	Kits	125
Concealed vertical rod devices for hollow metal doors (48A)	37	Parts and accessories	126
Options	40	94/95 impact Series	127
Kits	44	94/95 Series Overview	127
Parts and accessories	48	94/95 Series Configure a product	130
55 Series	54	Concealed vertical rod devices (47)	130
55 Series Overview	54	Concealed vertical rod devices (48)	131
55 Series Configure a product	57	Mortise lock devices (75)	132
Rim devices	57	Options	133
Concealed vertical rod devices (47)	58	Kits	133
Wood Door Concealed vertical rod devices (47-WDC)	59	Parts and accessories	134
Mortise lock devices (75)	60	2670 Guard-X Series	135
Options	61	2670 Guard-X Series Overview	135
Parts and accessories	62	2670 Guard-X Configure a product	137
88 Series	67	Options	137
88 Series Overview	67	Parts and accessories	138
88 Series Configure a product	71		
Rim devices	71		
Surface vertical rod devices (27)	72		
Concealed vertical rod devices (47)	73		
Mortise lock devices (75)	74		
Options	75		
Parts and accessories	76		

Accessories and parts	139
Dummy cross/touch bars.....	140
Parts and accessories.....	140
Strikes.....	141
Trims.....	143
22 Series.....	143
33A/35A Series.....	143
55 Series.....	144
88 Series.....	144
98/99 Series.....	145
94/95 Series.....	147
Parts and accessories.....	148
Control trims.....	155
360 Series.....	155
370 Series.....	156
Parts and accessories.....	157
Cylinder controls.....	162
Cover plates, cylinders and glass bead kits.....	163
Mullions.....	164
Rod and latch guards.....	166
Mortise locks.....	167
237 Two point latch.....	168
Extension rod kits.....	170
Security screw packages.....	171
Sex bolts.....	172
SLM blocking mounting packages.....	172
Screw packs/Shims/Miscellaneous.....	173
Maintenance kit and replacement packages.....	174
Service replacement parts.....	175

Electrical products and parts	177
Exit Alarm kits.....	178
Mortise locks.....	179
Switches.....	179
Delayed exit system.....	180
Interface boxes/relays.....	180
Allegion Connect.....	181
Electric power transfers.....	181
Power supplies.....	182
Electric strikes.....	184
Schlage® Electronic exit trim.....	189
Electrified kits.....	195
Part number cross reference	199
Wiring diagrams	202



Policies and documents

The purchase of Allegion products is governed by the Allegion Authorized Seller Program. For program terms and conditions, and other program details, please visit:

USA www.allegion.com/AuthorizedSeller
 CAN www.allegion.ca/policies

For Warranty information, visit us.allegion.com/warranty or contact Customer Service at:

USA 877-671-7011
 CAN 800-900-4734



Online ordering is available through Overtur™ Estimate and Order (OEO)

OEO offers much more than placing online orders including:

- Provides net price for direct customers and list price for indirect customers, integrator partners and end-users
- Online Ordering for direct customers
- Automated price updates
- Ability to export price lists and cross-reference guides in Excel
- Configuration and configuration reports, including e-lock configurations
- Request a quote or quote revision from an estimate
- Keying Guide
- Library pre-built hardware sets

How to get it:

1. Login or register at <http://360portal.allegion.com>
2. Find the Estimate and Order Icon and follow the instructions to request access
3. The Online Ordering team will begin working on your access with your Allegion Sales Representative

Traditional ordering methods

United States

✉ Allegion_Orders@allegion.com
 ☎ 1-800-248-1460

Canada

✉ Canada.Orders.Service@allegion.com
 ☎ 1-800-209-4734

Training and Troubleshooting



Scan the QR Code to access our resource center or visit <https://support.oeo.allegion.com/hc/en-us>

Questions or issues should be reported to Online.Ordering.Support@allegion.com for escalation

You can **configure and price a full range of products** using the tables and rules shown in this book.

The simplified structure of pricing and product data in this book creates an easier configuration experience and a quicker update process for future price increases. Pricing logic used in this format makes the product and price easier to understand and has enabled Allegion to provide customers with a **digital data set of pricing, available for download at <http://360portal.allegion.com>**.

As a result, the **How to Order formats have been updated to match the Allegion Catalog Nomenclature (ACN) logic**. ACNs are descriptive, unique identifiers that set standards on how to order products and require default, consistent naming conventions for all product attributes across Allegion brands.

FINISHES

BHMA	US	DESCRIPTION
526		Powder-Coated Chrome
605	US3	Brass, Polished
606	US4	Brass, Satin
611	US9	Bronze, Polished
612	US10	Bronze, Satin
613	US10B	Bronze, Oil-Rubbed Satin
619	US15	Nickel, Satin
622	US19	Powder-Coated Matte Black
625	US26	Chrome, Polished
626	US26D	Chrome, Satin
626AM	US26D-AM	Chrome, Satin with Antimicrobial Coating
628	US28	Aluminum, Anodized

BHMA	US	DESCRIPTION
629	US32	Stainless Steel, Polished
630	US32D	Stainless Steel, Satin
630AM	US32D-AM	Stainless Steel, Satin with Antimicrobial Coating
643e		Aged Bronze
689	SP28	Powder-Coated Aluminum
693	SPBLK	Black, Paint (not flat powder)
695	SP313	Powder-Coated Dark Bronze
710	313	Duranodic Dark Bronze
711	315	Flat Black
721	US3A	Brass, Polished - no lacquer
728	US4A	Brass Satin - no lacquer

Note: See device finish pages for available finishes offered for each device.

SPLIT FINISHES:

When split finish is desired, the finish listed first is understood to be the finish on the trim/control on the outside of door.

TOUCHBAR TRIM FINISHES:

When purchased as part of a device, optional touchbar trims are furnished at no additional charge. See device finish page for available finishes per device.

SPECIAL FINISHES

Optional powder coat finishes available on 33A, 35A, 55, 88, 94, 95, 98, 99, XP98 and XP99 Series devices. To have a specific color matched and powder coat availability please contact:

TIGER Drylac U.S.A., Inc.
3945 Swenson Ave.
St. Charles, IL. 60174 USA
800-243-8148
www.tiger-coatings.us

Powder coat must be selected from Tiger Drylac **Series 38 or 49**.

Please specify both the full powder coat product number and the RAL number when placing your order with Von Duprin.

Example: 49/15320 RAL 1015

CUSTOM GRAPHICS

Custom logo or unique artwork on push bar trim is available. Must provide a graphic file of artwork to be applied. The graphic should be native (not scaled) and must not exceed 16"x2". File format should be in Photoshop or .TIFF file format. For United States, the graphic file should be emailed to VDL_Specials@allegion.com. For Canada, contact customer care for more details. List add \$140.00/device plus non-discountable \$337.00 set-up charge per order.

SPECIAL FINISH PRICING















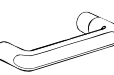



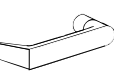





























33A, 35A, 94, 95, 98, 99, XP98, XP99 devices 24% list add to 628 price
22 devices 24% list add to 689 price, special finishes limited to 706, 691, and 693
55 and 88 devices..... 24% list add to 606 price
Steel Mullions..... 24% list add to 689 price

For other finishes not listed in this price book, consult factory for pricing.

REFERENCE

Devices ordered in 628 and 630 will be supplied with Trims in 626 unless SS levers are specified.

STANDARD LEVER DESIGNS

VON DUPRIN EXIT DEVICES 33A/35A, 94/95, 98/99	L-LOCK	ND	AL	S	F/FA
01 	01 				
02 	02 				
03 	03 	Tubular 			
05 	05 				
06 	06 	Rhodes 	Saturn 	Saturn 	Elan 
07 	07 	Athens 	Jupiter 	Jupiter 	Jazz 
12 	12 				Manhattan 
17 	17 	Sparta 	Neptune 	Neptune 	
18 	18 				
Latitude 	Latitude 				Latitude 
Longitude 	Longitude 				
16 	Omega 	Omega 	Omega 		
Asti 	Asti 			Flair 	Flair 
Merano 	Merano 				Merano 
Accent 	Accent 				Accent 

Note: Table shows matching lever styles among brands for suiting purposes.

M COLLECTION LEVER DESIGNS (CAST OR FORGED)

M51

Tactile option: 851 (knurled)

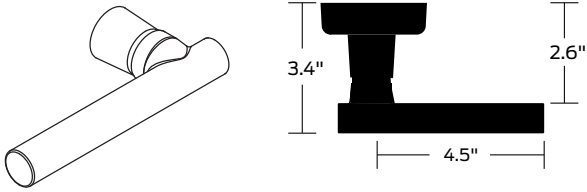

M52

Tactile option: 852 (knurled)

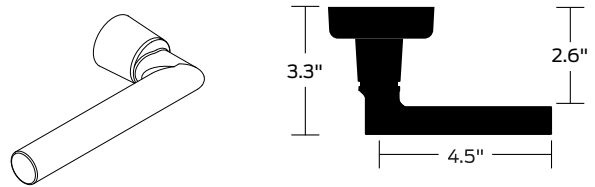

M53

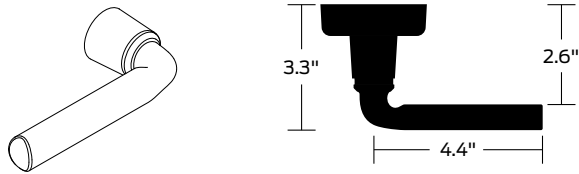

M54

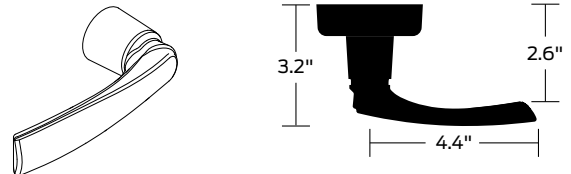

M55

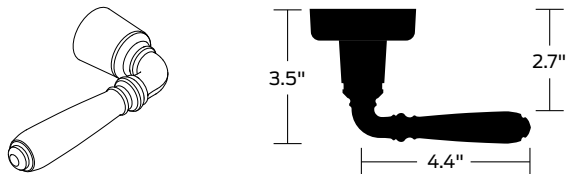

M56

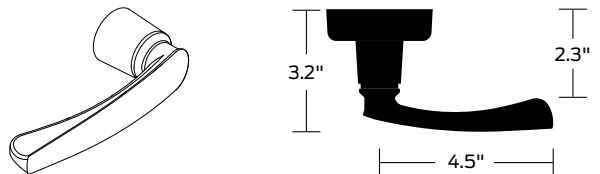

M57

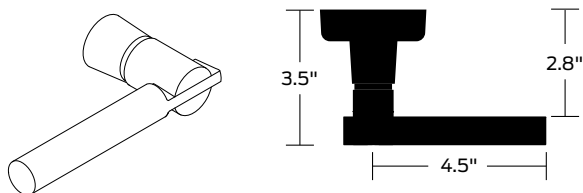

M61

Handing required

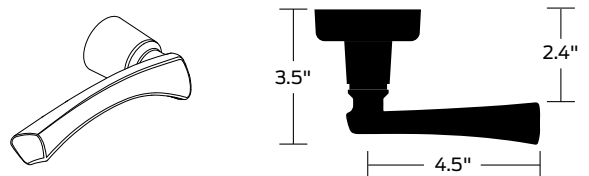

M62

Handing required

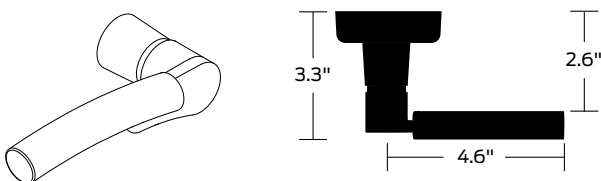

M63

Handing required

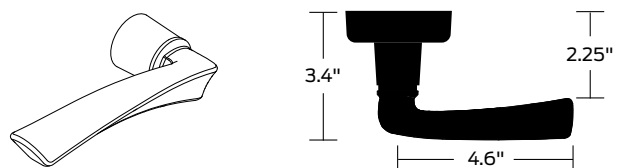

M COLLECTION LEVER DESIGNS (CAST OR FORGED)

M81

Tactile option: 881 (knurled)

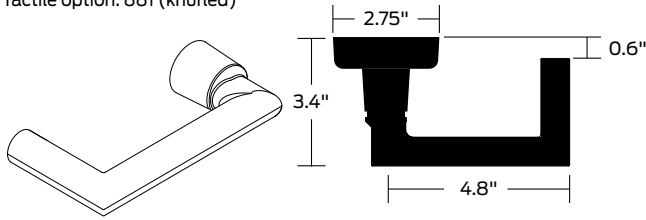

M82

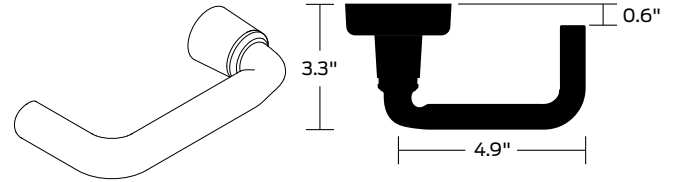

M83

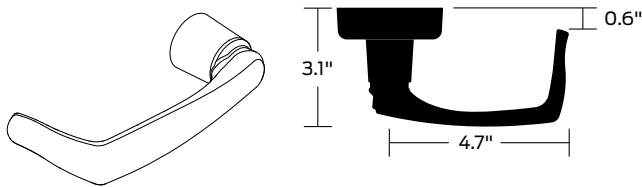

M84

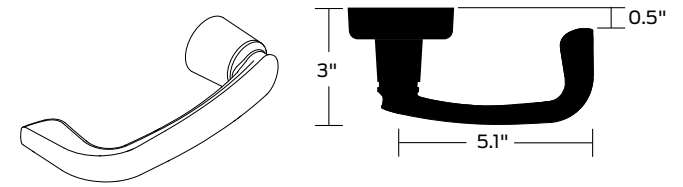

M85

Handing required

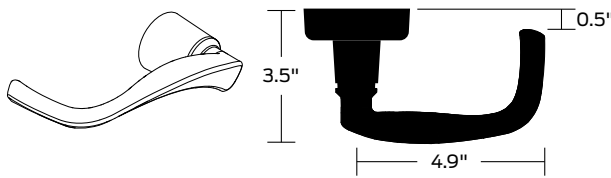

ME1

Tactile option: 8ME1 (milled)

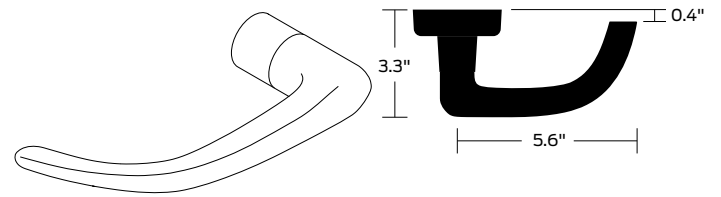

ME2

Tactile option: 8ME2 (milled)

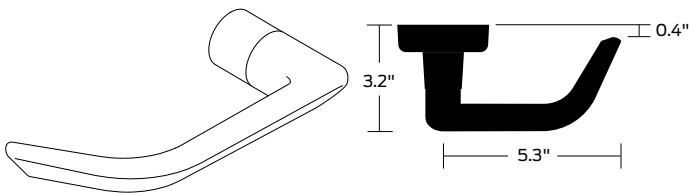

ME3

Tactile option: 8ME3 (milled)

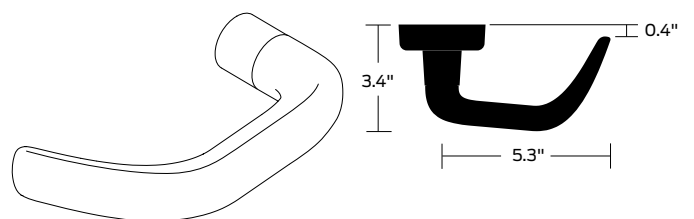

22 SERIES
33A/35A SERIES
55 SERIES
88 SERIES
98/99 SERIES
XP98/XP99 SERIES
94/95 SERIES
GUARD-X SERIES
ACCESSORIES / PARTS
ELECTRICAL / PARTS

DOOR WIDTHS

EXIT DEVICES for door widths exceeding 4'0" are custom applications. Door width is assumed 3'0" unless specified otherwise. Specify the exact door width and consult factory for price or see page 17.

DOOR THICKNESS

EXIT DEVICES are furnished at prices listed for door thicknesses of 1-3/4" and 2-1/4" with standard centerlines. Other door thicknesses and/or offset installations may require additional charges for the device, trim, control and/or strike. Consult factory for price or see pages 15, 16, and 17. Some extended door thickness applications are standard, see device option pages.

DOOR HEIGHTS/DEVICE CENTERLINE

SURFACE VERTICAL ROD DEVICES are furnished at prices listed for door heights up to 7'0". For heights above 7'0", extension rods are furnished at prices shown on page 170. For doors higher than 10'0" or when centerline is other than standard, specify exact height and/or centerline. Consult factory for price or see device page. ADA centerline of 37" is available at no additional charge, must be specified. Door height is assumed 7'0" unless specified otherwise.

CONCEALED VERTICAL ROD DEVICES are furnished at prices listed for door heights 6'8" to 8'4" on touch bar devices, and up to 8'0" on crossbar devices. For extension rods up to 10'0", see page 170 for prices. For heights other than this or when centerline is other than standard, specify exact height. Consult factory for price or see device page. Door height is assumed 7'0" unless specified otherwise.

HANDING

DEVICES: Furnished RHR when handing is not specified.

LEVER TRIMS: Trims are furnished RHR when handing is not specified.

CYLINDERS

We do not offer custom keying.

MARKING CARTONS

Markings (e.g., door locations, stock reference numbers) on acknowledgments and individual product cartons will be provided at no additional charge.

SUBSTITUTION OF OUTSIDE TRIM OR STRIKES

When standard is not desired, deduct price of standard and add price of item used. Check catalog for compatibility. Refer to device Product Catalogs for specific door application strike requirements.

ELECTRIC ACCESSORIES

When specifying Electrical Products, consult Product Catalog or factory to insure all required accessories have been specified.

PRODUCT CATALOGS

Refer to the Product Catalogs for required accessories and specific requirements.

LEVER DESIGNS

- The #06 lever is furnished standard.
- Optional lever designs, #01, #02, #03, #05, #07, #12, #16, #17, #18, Accent, Asti, Merano are available at no additional charge.
- Optional Stainless Steel levers, 03 SS, 06 SS, 17 SS, Latitude SS and Longitude SS are available at no additional charge.
- Optional Brass levers, Latitude and Longitude are available at no additional charge.
- Optional Knurled Levers available on #02, 03, 07, and 17 Lever designs. M51, M52, and M81 lever designs can be supplied Knurled as a Special. Refer to device pages for Levers offered per device.

605	606	611	612	613	619	622	625	626	626AM	628	629
US3	US4	US9	US10	US10B	US15	US19	US26	US26D	US26DAM	US28	US32
630	630AM	643e	689	691	693	695	706	710	711	721	728
US32D	US32DAM	-	SP28	SPIO	SPBLK	SP313	SP4	313	315	US3A	US4A

Prefix	Device series/type		Trim/rating		Suffix/finish		Door width	Handing	Less bottom rod/cable	Trim options/finish	Strike/lever style	Accessories	Other information												
1	2	3	4	5	6	7	8	9	10	11	12	13	14												
QEL	-	98	-	27	-	L	-	F	-	-	626	-	3'	-	RHR	-	LBR	-	996/626	-	299F/06	-	SNB	-	HM

Detail

1 Prefixes		4 Trim functions		10 Less bottom rod/cable	
None	Standard	K-DT	Knob, rigid - dummy trim	LBR	Less bottom rod
AX	Accessible device	K-NL	Knob, rigid - night latch	LBL	Less bottom latch
CD	Cylinder dogging - panic only	L	Lever (classroom)	LBR-AFL	LBR with fire pin
CX	Chexit	L-BE	Lever - blank escutcheon	LBL-AFL	LBL with fire pin
E	Electric locking mortise/lever	L-DT	Lever, rigid - dummy trim		
EL	Electric latch retraction	L-NL	Lever, rigid - night latch		
HH	Hurricane device	NL	Night latch		
LX	Latch bolt monitoring	NL-OP	Night latch cylinder assembly, optional pull		
PL	Pullman latch	TL	Turn lever		
PN	Pneumatic latch retraction	TL-BE	Turn lever - blank escutcheon		
QEL	Quiet electric latch retraction	TP	Thumbpiece		
QM	Quiet mechanical	TP-BE	Thumbpiece - blank escutcheon		
RX	Request to exit				
RX2	Double request to exit				
SD	Special dogging -panic only				
SS	Signal switch				
WS	Windstorm (FEMA rated) surface vertical rod device				
XP	Heavy protection - rim				
2 Device series		5 Rating		11 Trim options/finish	
22	Push bar device	F	Fire exit hardware		
33A/35A	Push bar device	Blank	Panic exit hardware		
55	Cross bar device				
88	Cross bar device				
94/45	Recessed device				
98/99	Push bar device				
3 Device type		6 Suffix		12 Lever style	
None	Rim device	-2	Double cylinder	06	Standard default (optional levers available)
27	Surface mounted vertical rod device	-2SI	Double cylinder with security indicator		
47	Concealed vertical rod device	CON	Connectors		
47WDC	Concealed vertical rod wood door device	WH	Weep holes		
48	Concealed vertical rod device				
49	Concealed vertical cable device (see CVC how to order form)				
50WDC	Concealed vertical cable wood door device				
52	Rim device with remote trim input (pool exit hardware)				
57	Three-point latch device				
75	Mortise lock device				
4 Trim functions		7 Finish		13 Accessories	
EO	AD trim (to come from client)	605	Bright Brass	CYL	Cylinder
DT	Dummy trim	606	Satin Brass	GBK	Glass bead kit
EO	Exit only	612	Satin Bronze	SEC	Security screws
HL	Hospital pull trim	619	Satin Nickel	SLM	SLM blocking
K	Knob	625	Bright Chrome	SNB	Sex bolts
K-BE	Knob - blank escutcheon	626	Satin Chrome		
		626AM	Satin Chrome, Antimicrobial		
		628	Aluminum, Anodized		
		630	Satin Stainless		
		630AM	Satin Stainless, Antimicrobial		
		643e	Aged Bronze		
		710	Dark Brown, Anodized		
		711	Flat Black		
		8 Door width		14 Other information	
		3'	Standard default	Touchbar options	
		4'	2 1/4" Optional	BRAILLE	Vision impaired touchpad, raised letter, and braille
		2'		EMB	Touchbar trim embossed 'PUSH'
		9 Handing		RSS	Red silk-screened lettered touchbar trim
		LHR	Left hand reverse	KN	Knurled touchbar
		RHR	Right hand reverse	SG	Safety glow
				Miscellaneous	
				CE	CE labeled
				LCP	Less cover plate
				10WDA	#10WDA cover plate
				RAT REL	Ratchet release assy
				Door material	
				ALD	Aluminum door
				HMD	Hollow metal
				WD	Wood door
				CP	Composite door
				INS2	Insulclad - 1/2"
				INS4	Insulclad - 1/4"
				SC	Steelcraft, HH device only
				Door application	
				DE	Double egress
				PR	Pair of doors
				SLG	Single door

Note: Not all options are listed. Not all options are available on all series. See the specific series pages for complete options available. Please contact customer care for questions.

SPECIAL ORDER PRODUCTS

- 22 SERIES
- 33A/35A SERIES
- 55 SERIES
- 88 SERIES
- 98/99 SERIES
- XP98/XP99 SERIES
- 94/95 SERIES
- GUARD-X SERIES
- ACCESSORIES / PARTS
- ELECTRICAL / PARTS

MORTISE LOCK ORDER FORM

For door thickness between 2-1/4"–4-1/2". See page 15 for pricing.

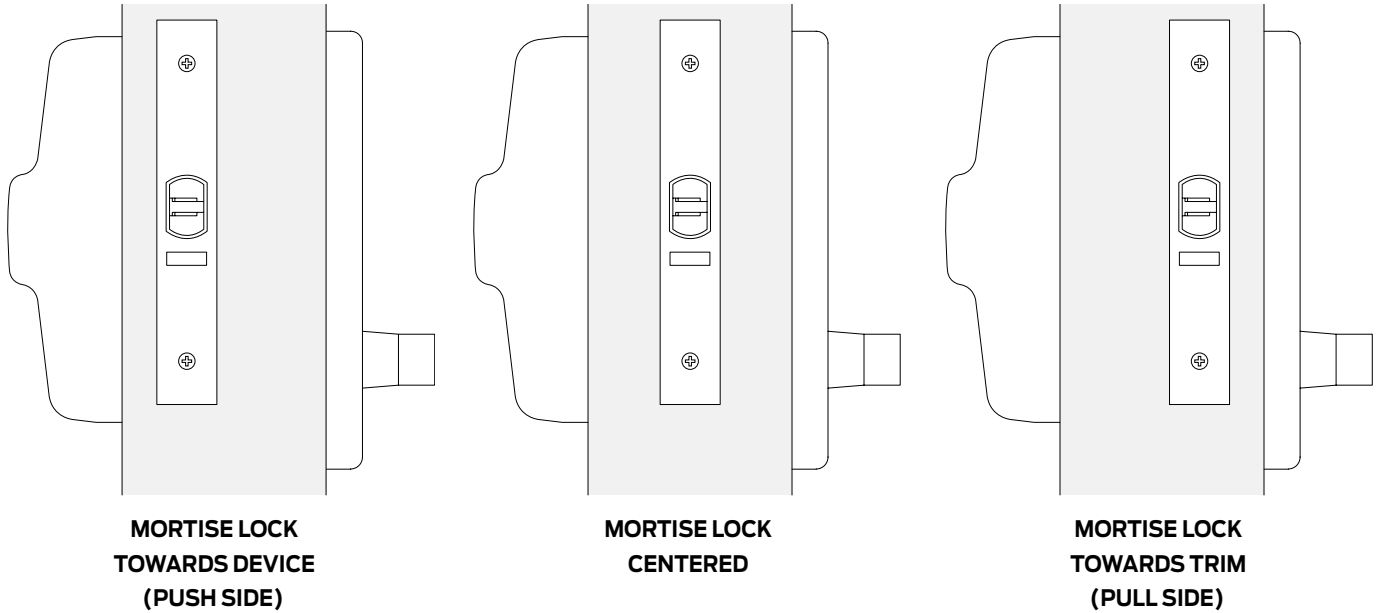

1. SELECT MORTISE LOCK POSITION (USING ILLUSTRATION ABOVE). Please check box in left column to indicate lock location.

	Push side. Please provide centerline dimension from push side .
	Center. Please provide centerline dimension from center .
	Pull side. Please provide centerline dimension from pull side .

2. SPECIFY DOOR THICKNESS.

Please provide **door thickness** in box to the left.

3. SPECIFY MORTISE LOCK CONFIGURATION (5575 / 8875 / 98/9975 / -F). Example: 9875-EO x 3' x US26D.

PRODUCTS TO BE SUPPLIED:

Mortise device - lock towards device (push) side <ul style="list-style-type: none"> ▪ Special strike ▪ Special screw pack ▪ Special trim (if not EO) 	Mortise device - lock centered <ul style="list-style-type: none"> ▪ Special device ▪ Special strike ▪ Special trim (if not EO) 	Mortise device - lock towards trim (pull) side <ul style="list-style-type: none"> ▪ Special device
---	---	---

DOOR THICKNESS - DEVICES ONLY

Prices shown are for a door thickness over 2-1/4" up to 4-1/4".

Trims for a door thickness other than standard are priced separately on pages 16 and 17.

22 SERIES			
Description	Specify	Price adjustment	Notes
No specials are available on the 22 Series	22	\$0.00	

55 SERIES			
Description	Specify	Price adjustment	Notes
Rim Device	55	\$128.00	Special Screw Pack
Mortise Device, Lock towards device (push) side	5575/5575-F	\$405.00	Special Strike Special Screw Package Special Trim (if not EO)
Mortise Device, Lock centered		\$775.00	Special Device Special Strike Special Trim (if not EO)
Mortise Device, Lock towards trim (pull) side		\$746.00	Special Device
Concealed Vertical Rod Device	5547/5547WDC/-F	\$128.00	Special Screw Pack

88 SERIES			
Description	Specify	Price adjustment	Notes
Rim device with sex bolts	88/88-F	\$128.00	Special Screw Pack
Mortise Device, Lock towards device (push) side	8875/8875-F	\$393.00	Special Strike Special Screw Package Special Trim (if not EO)
Mortise Device, Lock centered		\$754.00	Special Device Special Strike Special Trim (if not EO)
Mortise Device, Lock towards trim (pull) side		\$347.00	Special Device Special Screw Package

98/99 SERIES			
Description	Specify	Price adjustment	Notes
Mortise Device Lock towards Device(Push) Side	98/9975/-F	\$405.00	Special Strike Special Screw Package Special Trim (if not EO)
Mortise Device Lock Centered		\$775.00	Special Device Special Strike Special Trim (if not EO)
Mortise Device Lock towards Trim(Pull) Side		\$359.00	Special Device Special Screw Package

NOTE: Other special door and frame conditions may require additional charges. Consult factory for pricing.

Location of Mortise Lock must be provided when ordering. Please use forms on page 14 to provide correct information.

22 SERIES
 33A/35A SERIES
 55 SERIES
 88 SERIES
 98/99 SERIES
 XP98/XP99 SERIES
 94/95 SERIES
 GUARD-X SERIES
 ACCESSORIES / PARTS
 ELECTRICAL / PARTS

DOOR THICKNESS - TRIMS ONLY

Prices shown are for a door thickness over 2-1/4" up to 4-1/4".
See specific product below for maximum door thickness. Devices for a door thickness other than standard are priced separately on page 15.

33A/35A SERIES TRIM			
Description	Specify	Price adjustment	Notes
Dummy or Night Latch Trim	386DT and NL	\$128.00	Screw Pack for Device
Night Latch Cylinder Trim - 33A/35A	388	\$128.00	Screw Pack for Device
Dummy Trim	550DT	\$128.00	Screw Pack
Dummy Trim	392-6	\$128.00	Screw Pack
Thumbturn	360T and T-BE	\$185.00	

55 SERIES TRIM			
Description	Specify	Price adjustment	Notes
Dummy Trim	550DT	\$128.00	Screw Pack
Night Latch Trim	555NL/556NL	\$128.00	Screw Pack
Night Latch Cylinder Assembly	555NL-CA/556NL-CA	\$128.00	Screw Pack
Night Latch Cylinder Assembly	110MD-NL/WD-NL	\$128.00	Screw Pack

88 SERIES TRIM			
Description	Specify	Price adjustment	Notes
Exit Only, Dummy or Night Latch Trim	880EO, DT or NL	\$128.00	Screw Pack
Thumbpiece, up to 3-1/4"	880/608TP/TP-BE	\$345.00	Thumbpiece and Screw Pack
Thumbpiece, over 3-1/4" up to 4-1/4"		\$576.00	Thumbpiece and Screw Pack
Knob, up to 4-1/4"	880/606K/K-BE/K-NL	\$437.00	Spindle and Screw Pack
Knob Dummy	880K-DT	\$128.00	Screw Pack
Dummy or Night Latch Trim	608DT or NL	\$128.00	Screw Pack
Knob Dummy	606K-DT	\$128.00	Screw Pack

98/99 SERIES TRIM			
Description	Specify	Price adjustment	Notes
Dummy or Night Latch Trim	696/697DT or NL	\$128.00	Screw Pack
Thumbpiece, up to 4-1/4"	990/696/697TP/TP-BE	\$355.00	Thumbpiece and Screw Pack
Knob	996K/K-BE/K-NL	\$421.00	Spindle and Screw Pack
Knob Dummy	996K-DT	\$128.00	Studs
Exit Only Plate	996EO	\$238.00	Screw Pack and Studs
Dummy Trim	392-7	\$124.00	Screw Pack

NOTE: Other special door and frame conditions may require additional charges. Consult factory for pricing.

DOOR THICKNESS - CONTROLS ONLY

Prices shown are for a door thickness over 2-1/4" up to 4-1/4".
 Devices for a door thickness other than standard are priced separately on page 15.

CONTROLS			
Description	Specify	Price adjustment	Special items required
Lever	371L/LBE	\$450.00	Cam and Screw Pack
Lever, up to 2-11/16" dr for 88L	373L/L-BE	\$126.00	Screw Pack
Lever, over 2-11/16" up to 4-1/4" for 88L		\$605.00	Spindle and Screw Pack
Lever, up to 3-3/8" for 8827L		\$126.00	Screw Pack
Lever, over 3-3/8" up to 4-1/4" for 8827L		\$605.00	Spindle and Screw Pack
Lever, up to 3-5/8" for 8875L		\$126.00	Screw Pack
Lever, over 3-5/8" up to 4-1/4" for 8875L		\$605.00	Spindle and Screw Pack
Lever, over 2-1/4" up to 4-1/4" ordered without a device		\$605.00	Spindle and Screw Pack
Lever Dummy		373L-DT	\$126.00
Lever, up to 3-5/8" for 5575L	375L/L-BE	\$126.00	Screw Pack
Lever, over 3-5/8" up to 4-1/4" for 5575L		\$605.00	Spindle and Screw Pack
Lever Dummy	375L-DT	\$126.00	Screw Pack
Lever	378L/L-BE	\$450.00	Cam and Screw Pack
Lever	379L/L-BE	\$605.00	Spindle and Screw Pack
Thumbturn	374T/T-BE	\$352.00	Rod Member and Screw Pack
Thumbturn/Lever	376T/T-BE/L/L-BE	\$631.00	Rod Cam and Screw Pack
Thumbturn/Lever	376T-WDC T/T-BE/L/L-BE	\$631.00	Rod Member and Screw Pack
Thumbturn, over 2-1/4" door	377T/T-BE	\$631.00	Rod Cam and Screw Pack

DOOR WIDTH - DEVICES ONLY

Prices shown are for door widths over 4' up to 6'.

33/35/98/99 SERIES			
Description	Specify	Price adjustment	Notes
All finishes	> 4' up to 5'	\$304.00	Device will ship less label

33/35/98/99 SERIES			
Description	Specify	Price adjustment	Notes
All finishes	> 5' up to 6'	\$431.00	Device will ship less label

55 OR 88 SERIES			
Description	Specify	Price adjustment	Notes
626 or 625	> 4' up to 5'	\$369.00	Device will ship less label
605, 606, 612, 613, 693	> 4' up to 5'	\$580.00	Device will ship less label

Note: Device will be supplied with a 49" reinforcement crossbar kit. Actual crossbar length is 54".

For Special Order Product Quotes:
 For United States, email VDI_Specials@allegion.com or fax 1-877-730-6248
 For Canada, contact customer care at 800-900-4734

III
 22 SERIES
 33A/35A SERIES
 55 SERIES
 88 SERIES
 98/99 SERIES
 XP98/XP99 SERIES
 94/95 SERIES
 GUARD-X SERIES
 ACCESSORIES / PARTS
 ELECTRICAL / PARTS

DOOR WIDTH - DEVICES ONLY

Prices shown are for door widths over 4' up to 6'.

55 OR 88 SERIES			
Description	Specify	Price adjustment	Notes
626 or 625	> 5' up to 6'	\$502.00	Device will ship less label
605, 606, 612, 613, 693	> 5' up to 6'	\$726.00	Device will ship less label

Note: Device will be supplied with a 61" reinforcement crossbar kit. Actual crossbar length is 66".

For Special Order Product Quotes: Email: VDI_Specials@allegion.com Fax: 1-877-730-6248

SPECIAL DEVICE TYPES		
Description	Price adjustment	Notes
Modified California Special - Centerline at 38"	\$744.00	5547WDC Only
Balanced Door - 3' Device with 4' Mechanism Case	\$130.00	33/35/98/99 Series

SPECIAL ELECTRIC STRIKE		
Description	Price adjustment	Notes
6221/6223/6226 with "A" Back Box	\$125.00	

SPECIAL MULLION		
Description	Price adjustment	Notes
Aluminum Mullions >10' up to 11'	\$1,220.00	5654/5754
Steel Mullions >10' up to 14'	\$816.00	1654/4754/4854/4954/9854/9954

SPECIAL CENTERLINE (OTHER THAN 39-11/16")		
Description	Price adjustment	Notes
Steel Mullion	\$142.00	
Aluminum Mullion	\$629.00	

ADA centerline height of 37" is available at no additional charge, must be specified.

EXIT DEVICES

- EXIT DEVICES
- 22 SERIES
- 33A/35A SERIES
- 55 SERIES
- 88 SERIES
- 98/99 SERIES
- XP98/XP99 SERIES
- 94/95 SERIES
- GUARD-X SERIES
- ACCESSORIES / PARTS
- ELECTRICAL / PARTS

22 SERIES

605	606	611	612	613	619	622	625	626	626AM	628	629
US3	US4	US9	US10	US10B	US15	US19	US26	US26D	US26DAM	US28	US32
630	630AM	643e	689	691	693	695	706	710	711	721	728
US32D	US32DAM	-	SP28	SP10	SPBLK	SP313	SP4	313	315	US3A	US4A

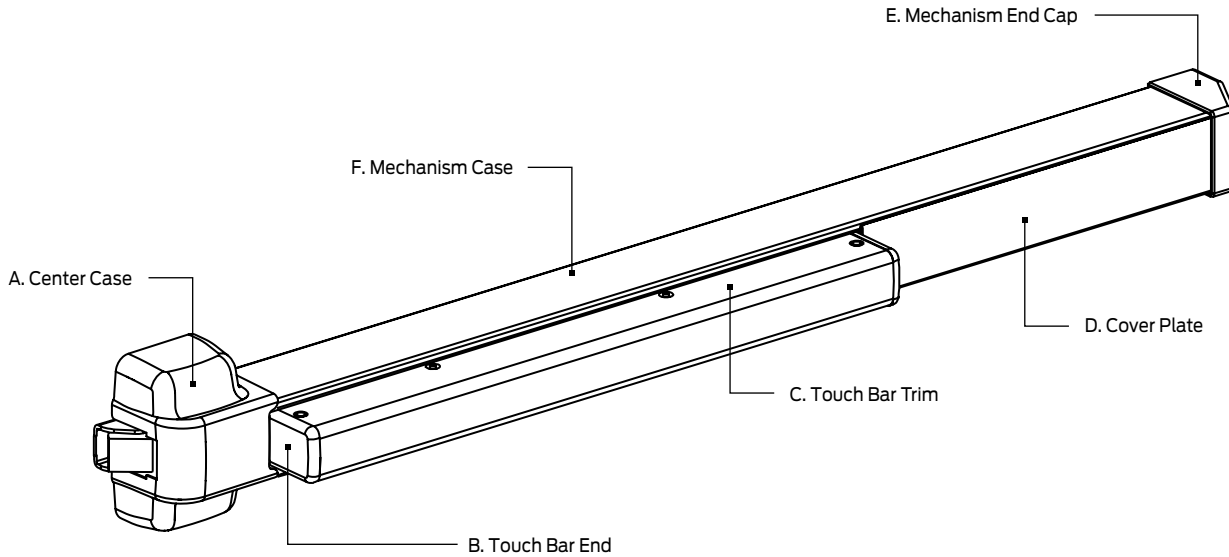

STANDARD FINISHES					
COLOR	US NUMBER	BHMA NUMBER	A, B, E	C - TOUCH BAR TRIM FINISHES	D, F
Powder-Coated Aluminum	SP28	689	(A) Powder Coat (B, E) Molded Plastic	Powder Coat, 689 (SP28)	Powder Coat
Powder-Coated Dark Bronze	SP313	695	(A) Powder Coat (B, E) Molded Plastic	Powder Coat, 695 (SP313)	Powder Coat
Powder-Coated Matte Black	US19	622	(A) Powder Coat (B, E) Molded Plastic	Powder Coat, 622 (US19)	Powder Coat
Powder-Coated Chrome	-	526	(A, E) Powder Coat (B) Molded Plastic	Powder Coat, 526	Powder Coat, 526

22 SERIES SEX BOLT QUANTITIES			
APPLICATION	SEX BOLT 425 (OPTIONAL)	WITH 499 STRIKE 425 SEX BOLT (OPTIONAL)	325 SEX BOLTS FOR SURFACE VERTICAL LATCHES (SUPPLIED)
EO (exit only device)	6	8	4
NL-OP Device with 110 MD/WD	6	8	4
EO Device with 230EO trim	2	4	4
K, K-BE, DT or NL Device with 210 trim	2	4	4
L, L-BE, TP or TP-BE Device with 230 trim	2	4	4

Note: Sex bolts are supplied for use on wood and composite fire doors.

 Indicates products that have EPD documentation available and meet LEED v4.

22 SERIES

605	606	611	612	613	619	622	625	626	626AM	628	629
US3	US4	US9	US10	US10B	US15	US19	US26	US26D	US26DAM	US28	US32
630	630AM	643e	689	691	693	695	706	710	711	721	728
US32D	US32DAM	-	SP28	SP10	SPBLK	SP313	SP4	313	315	US3A	US4A

TYPE OF DEVICE	
22 Rim	2227 Surface Vertical Rod
FUNCTION	
EO: Exit Only	DT: Dummy Trim
NL: Night Latch, Key Retracts	NLOP: Night Latch, Opt. Pull
TP: Thumbpiece	TPBE: Thumbpiece, Blank Escutcheon
L: Lever, 06 Standard	LBE: Lever, Blank Escutcheon
K: Knob	KBE: Knob, Blank Escutcheon
RATING	
None: Panic Exit Device	F: Fire Exit Device
DEVICE FINISH	
689: Powder-Coated Aluminum (SP28)	695: Powder-Coated Dark Bronze (SP313)
622: Powder-Coated Matte Black	526: Powder-Coated Chrome
DEVICE LENGTH (FEET AND INCHES)	
3ft: 3' Device for 2' 4" - 3' Door	4ft: 4' Device for 2' 10" - 4' Door
DEVICE HANDING	
RHR: Right Hand Reverse	LHR: Left Hand Reverse
TRIM OPTIONS	
LT: Less trim	210: Standard for DT, NL and K trim
230: Standard for L, TP trim	110WD-NL / 110MD-NL: Night Latch Cyl-WD door/MD door
TRIM FINISH	
613: Satin Bronze-Oil Rubbed (US10B)	626: Satin Chrome (US26D)
622: Powder-Coated Matte Black	526: Powder-Coated Chrome
689: Powder Coat Aluminum (US28)	695: Powder Coat Dark Bronze, (SP313)
STRIKE FINISH	
613: Satin Bronze-Oil Rubbed (US10B)	622: Flat Black (US19)
695: Dark Bronze (SP313)	626: Satin Chrome (US26D)
630: Satin Stainless (US32D)	
DOGGING OPTIONS	
LD: Less Dogging	
DEVICE OPTIONS	
ALK: Standard Alarm Kit	SNB: Include # of Sex Bolts
SEC: Include Security Screws	AX: Accessible Device
HW: Wind Only - Hurricane Rated	GBK: Include GBK
	RX: Request to Exit
	CYL: Include Cylinder
	LX: Latch Bolt Monitoring
LATCH RETRACTION OPTIONS	
QEL: Quiet Electric Latch Retraction	

22 SERIES

605	606	611	612	613	619	622	625	626	626AM	628	629
US3	US4	US9	US10	US10B	US15	US19	US26	US26D	US26DAM	US28	US32
630	630AM	643e	689	691	693	695	706	710	711	721	728
US32D	US32DAM	-	SP28	SP10	SPBLK	SP313	SP4	313	315	US3A	US4A

RODS FOR SURFACE VERTICAL DEVICES ONLY

LBR: Less Bottom Rod LBRAFL: LBR with Aux. Fire Pin

MISC

CE: CE Labeled CON: Connectors

DOOR MATERIAL

ALD: Aluminum Door HMD : Hollow Metal WD: Wood Door CP: Composite Door

FRAME MATERIAL

ALF: Aluminum Frame HMF: Hollow Metal Frame WDF: Wood Frame

DOOR THICKNESS

DT1-3/4: 1-3/4" Standard DT2: 2" thickness DT2-1/4: 2-1/4" thickness

DOOR MODE/APPLICATION

DE: Pair Double egress doors PR: Pair of doors SGL: Single door

22 SERIES

605	606	611	612	613	619	622	625	626	626AM	628	629
US3	US4	US9	US10	US10B	US15	US19	US26	US26D	US26DAM	US28	US32
630	630AM	643e	689	691	693	695	706	710	711	721	728
US32D	US32DAM	-	SP28	SP10	SPBLK	SP313	SP4	313	315	US3A	US4A

Rim devices

ACN							PRICE BASED ON FINISH			Default trim, included
Device type	Function	Fire	Finish	Device size	Handing	Lever design	689 or 695	526	622	
EXIT HARDWARE							3' DEVICE PRICING SHOWN. 4' ADD \$26.00 LIST			
22	EO	.	[]	[]	.	[]	\$646	\$844	\$714	N/A
22	DT	.	[]	[]	.	[]	\$720	\$940	\$794	210DT
22	NL	.	[]	[]	.	[]	\$731	\$955	\$808	210NL
22	NL-OP	.	[]	[]	.	[]	\$834	\$1,032	\$902	110MD/WD
22	K ¹	.	[]	[]	.	[]	\$979	\$1,278	\$1,081	210K
22	K-BE	.	[]	[]	.	[]	\$979	\$1,278	\$1,081	210K-BE
22	L	.	[]	[]	[]	[]	\$973	\$1,271	\$1,074	230L
22	L-BE	.	[]	[]	[]	[]	\$973	\$1,271	\$1,074	230L-BE
22	TP	.	[]	[]	.	[]	\$970	\$1,266	\$1,071	230TP
22	TP-BE	.	[]	[]	.	[]	\$970	\$1,266	\$1,071	230TP-BE
FIRE EXIT HARDWARE							3' DEVICE PRICING SHOWN. 4' ADD \$26.00 LIST			
22	EO	F	[]	[]	.	[]	\$815	\$1,064	\$901	N/A
22	DT	F	[]	[]	.	[]	\$889	\$1,160	\$981	210DT
22	NL	F	[]	[]	.	[]	\$900	\$1,175	\$995	210NL
22	NL-OP	F	[]	[]	.	[]	\$1,003	\$1,252	\$1,089	110MD/WD
22	K	F	[]	[]	.	[]	\$1,148	\$1,498	\$1,268	210K
22	K-BE	F	[]	[]	.	[]	\$1,148	\$1,498	\$1,268	210K-BE
22	L	F	[]	[]	[]	[]	\$1,142	\$1,491	\$1,261	230L
22	L-BE	F	[]	[]	[]	[]	\$1,142	\$1,491	\$1,261	230L-BE
22	TP	F	[]	[]	.	[]	\$1,139	\$1,486	\$1,258	230TP
22	TP-BE	F	[]	[]	.	[]	\$1,139	\$1,486	\$1,258	230TP-BE

¹ K: Includes cylinder

DEFAULT ATTRIBUTES

Pricing includes default options shown below. Additional options and configurations available.

Cylinders:	Sex bolts	Door thickness	Center line
Included only for K function	Not included	1-3/4"	39-13/16"

Strike(s):

Exit hardware:

- Includes 299 strike

Fire exit hardware:

- Single door applications: Includes 299F strike
- Double door applications: 499F strike will be supplied at an additional \$150.00 list add

22 SERIES

605	606	611	612	613	619	622	625	626	626AM	628	629
US3	US4	US9	US10	US10B	US15	US19	US26	US26D	US26DAM	US28	US32
630	630AM	643e	689	691	693	695	706	710	711	721	728
US32D	US32DAM	-	SP28	SP10	SPBLK	SP313	SP4	313	315	US3A	US4A

Surface vertical rod devices (27A)

ACN							PRICE BASED ON FINISH			Default trim, included
Device type	Function	Fire	Finish	Device size	Handing	Lever design	689 or 695	526	622	
EXIT HARDWARE							3' DEVICE PRICING SHOWN. 4' ADD \$26.00 LIST			
2227	EO	.	[]	[]			\$1,113	\$1,311	\$1,181	N/A
2227	DT	.	[]	[]			\$1,187	\$1,407	\$1,261	210DT
2227	NL	.	[]	[]			\$1,198	\$1,422	\$1,275	210NL
2227	NL-OP	.	[]	[]			\$1,301	\$1,499	\$1,369	110MD/WD
2227	K ¹	.	[]	[]			\$1,446	\$1,745	\$1,548	210K
2227	K-BE	.	[]	[]			\$1,446	\$1,745	\$1,548	210K-BE
2227	L	.	[]	[]	[]	[]	\$1,440	\$1,738	\$1,541	230L
2227	L-BE	.	[]	[]	[]	[]	\$1,440	\$1,738	\$1,541	230L-BE
2227	TP	.	[]	[]			\$1,437	\$1,733	\$1,538	230TP
2227	TP-BE	.	[]	[]			\$1,437	\$1,733	\$1,538	230TP-BE
FIRE EXIT HARDWARE							3' DEVICE PRICING SHOWN. 4' ADD \$26.00 LIST			
2227	EO	.	F	[]	[]		\$1,456	\$1,705	\$1,542	N/A
2227	DT	.	F	[]	[]		\$1,530	\$1,801	\$1,622	210DT
2227	NL	.	F	[]	[]		\$1,541	\$1,816	\$1,636	210NL
2227	NL-OP	.	F	[]	[]		\$1,644	\$1,893	\$1,730	110MD/WD
2227	K ¹	.	F	[]	[]		\$1,789	\$2,139	\$1,909	210K
2227	K-BE	.	F	[]	[]		\$1,789	\$2,139	\$1,909	210K-BE
2227	L	.	F	[]	[]	[]	\$1,783	\$2,132	\$1,902	230L
2227	L-BE	.	F	[]	[]	[]	\$1,783	\$2,132	\$1,902	230L-BE
2227	TP	.	F	[]	[]		\$1,780	\$2,127	\$1,899	230TP
2227	TP-BE	.	F	[]	[]		\$1,780	\$2,127	\$1,899	230TP-BE

¹ K: Includes cylinder

DEFAULT ATTRIBUTES

Pricing includes default options shown below. Additional options and configurations available.

Cylinders:	Sex bolts	Door thickness	Center line
Included only for K function	Included for latches	1-3/4"	39-13/16"

Strike(s):

- Exit hardware: Includes 299 top strike, 248L-4 and 304L bottom strikes
- Fire exit hardware: Includes 299F top strike and 304L bottom strike

OPTIONS

605	606	611	612	613	619	622	625	626	626AM	628	629
US3	US4	US9	US10	US10B	US15	US19	US26	US26D	US26DAM	US28	US32
630	630AM	643e	689	691	693	695	706	710	711	721	728
US32D	US32DAM	-	SP28	SP10	SPBLK	SP313	SP4	313	315	US3A	US4A

LESS BOTTOM ROD (LBR Fire-Rated Devices must be ordered in pairs, and one Auxiliary Fire Pin (AFL) is furnished per pair.)	Specify (Suffix)	Price adjustment
2227LBR	LBR	-\$164.00
2227-F-LBR (First Leaf)	LBR	\$0.00
2227-F-LBR-AFL (Second Leaf)	LBR-ALF	\$0.00

DOGGING - NOT FOR USE WITH FIRE EXIT HARDWARE		
Description	Specify	Price adjustment
Less dogging for 22 Series Panic Devices	LD	\$0.00

SWITCHES (AVAILABLE ON ALL 22 SERIES DEVICES)		
Description	Specify	Price adjustment
Request to Exit	RX	\$365.00
Waterproof Request to Exit	WPRX	\$529.00
Request to Exit Low Current	RXLC	\$424.00
Request to Exit Double Switch	RX2	\$455.00
Latch Bolt Monitoring	LX	\$365.00
Latch Bolt Monitoring Low Current	LXLC	\$424.00
Request to Exit / Latch Bolt Monitoring combination	LXRX	\$552.00
Request to Exit / Latch Bolt Monitoring combination Low Current	LXRXLC	\$665.00

LATCH RETRACTION - See 22 Series product catalog for required accessory equipment	Specify (Prefix)	Price adjustment
Quiet electric latch retraction	QEL	\$1,258.00
Quiet electric latch retraction with hex dogging (panic only)	HD-QEL	\$1,258.00
Quiet electric latch retraction for AX devices	QELX	\$1,338.00
Quiet electric latch retraction with hex dogging (panic only) for AX devices	HD-QELX	\$1,338.00

STORM RATING

HURRICANE DEVICE - USE WITH APPROVED ALLEGION DOOR APPLICATIONS
Specify HH (Wind and Impact) or HW (Wind-Only) prefix when ordering devices or mullions for hurricane applications. If application is unknown, specify HH which will satisfy the requirements for both applications. HH option only available for select series and models. HH/HW devices will be furnished with strikes shown in charts (and with through bolts if HH product) and are price-adjusted as indicated. Mullions priced separately.

HW (WIND-ONLY)						
Model	Door mode	Mullion	Standard strike		Specify (Prefix)	Price adjustment
22 Rim	SGL	-	299		HW	\$0.00
22 Rim	PR	4954 or KR4954	299		HW	\$0.00
22-F Rim	SGL	-	299F		HW	\$0.00
22-F Rim	PR	9954 or KR9954	499F		HW	\$150.00
2227	SGL or PR	-	Top: 299	Bottom: 304L	HW	-\$82.00
2227-F	PR	-	Top: 299F	Bottom 304L	HW	\$0.00

OPTIONS

605	606	611	612	613	619	622	625	626	626AM	628	629
US3	US4	US9	US10	US10B	US15	US19	US26	US26D	US26DAM	US28	US32
630	630AM	643e	689	691	693	695	706	710	711	721	728
US32D	US32DAM	-	SP28	SP10	SPBLK	SP313	SP4	313	315	US3A	US4A

ACCESSIBLE DEVICE

Description	Specify	Price adjustment
<ul style="list-style-type: none"> Accessible device compliant with the California Building Code (Section 11B-309.4) requirement for 5 lb. maximum operational force. Available on AX22, AX22-F Rim, AX2227-LBR, AX2227-LBR-F. Trim functions available EO, DT, NL, L, and LBE. 	AX	\$34.00

EXIT ALARM

Description	Specify	Price adjustment
<ul style="list-style-type: none"> Exit alarm available on 22 Series Panic and Fire Devices. Price includes switch - "RX" switch, "LX" is optional at no additional charge. To order Less switch, deduct \$365.00 list. For vertical rod tampering monitoring on Surface Vertical Devices, specify device with LX (Latch Bolt Monitor Switch). 9 volt battery included. 	ALK	\$805.00

CONNECTORS

Description	Specify	Price adjustment
Cross-category solution using interconnect components for electrified options. Available with ALK, LX, LXLC, LXR, LXRXC, RX, RXLC, and WPRX switches.	CON	\$0.00

KITS

MODULAR QEL CONVERSION KITS - FIELD CONVERSION KITS FOR QUIET ELECTRIC LATCH RETRACTION

Description	Specify		Price adjustment
	Standard	Allegion Connect (CON)	
22 QEL Conversion Kit	47447540	47857518	\$1,258.00
22 HD-QEL conversion kit w/dogging	47447541	47857519	\$1,258.00
22 QELX conversion kit	47447544	47857521	\$1,338.00
22 HD-QELX conversion kit w/dogging	47447547	47857523	\$1,338.00

Von Duprin 22 Series devices modular conversion kits compatible with devices manufactured after January 1, 2022 (no seam on the mechanism case).

QEL BUZZER	Specify	Price each
QEL-B modular buzzer kit	47856044	\$357.00

PARTS AND ACCESSORIES

605	606	611	612	613	619	622	625	626	626AM	628	629
US3	US4	US9	US10	US10B	US15	US19	US26	US26D	US26DAM	US28	US32
630	630AM	643e	689	691	693	695	706	710	711	721	728
US32D	US32DAM	-	SP28	SPI0	SPBLK	SP313	SP4	313	315	US3A	US4A

CENTER CASE							
Description	Specify			Non-finished	689 695	526	622
	Part number	Finish					
22/22-F Rim Center Case Less Cover	109012	-		\$421.00	-	-	-
2227/27-F Center Case Less Cover	CASE.107	-		\$338.00	-	-	-
22/22-F Center Case Cover	041174	.[Finish]		-	\$79.00	\$94.00	\$87.00
2227/27-F Center Case Cover	041175	.[Finish]		-	\$79.00	\$94.00	\$87.00
22 Center Case Cover Screw Pkg/4	090077	-		\$17.00	-	-	-
22 Series Mounting Package	900392	-		\$34.00	-	-	-
Control Link Pin Kit	050529	-		\$19.00	-	-	-
Retaining Ring Pkg/10	090107	-		\$19.00	-	-	-
NL Drive Screw Pkg/10	090074	-		\$30.00	-	-	-
2227 Latch Bolt Pin Pkg/10	090079	-		\$19.00	-	-	-
22 Pushbar Stop	965409	-		\$19.00	-	-	-

PUSH BAR								
Description	Specify				Non-finished	689 695	526	622
	Part number	Device type	Size	Finish				
22 Series Push Bar - 3'	PBKIT	.[]	.3ft	.[Finish]	-	\$272.00	\$321.00	\$301.00
22 Series Push Bar - 4'	PBKIT	.[]	.4ft	.[Finish]	-	\$286.00	\$337.00	\$315.00

MECHANISM CASE							
Description	Specify			Non-finished	689 695	526	622
	Part number	Finish					
22 End Cap Kit	900981	-		\$30.00	-	-	-
22 Series Metal End Cap	900397	.[Finish]		-	-	\$48.00	\$43.00
22/2227 Cover Plate - 3' Dr	968595	.[Finish]		-	\$76.00	\$89.00	\$85.00
22/2227 Cover Plate - 4' Dr	968596	.[Finish]		-	\$76.00	\$89.00	\$85.00
22-F/2227-F Cover Plate - 4' Dr	969126	.[Finish]		-	\$76.00	\$89.00	\$85.00
22-F/2227-F Cover Plate - 3' Dr	969127	.[Finish]		-	\$76.00	\$89.00	\$85.00
227 Dog Key 5/32" Pkg/2	090005	-		\$30.00	-	-	-
227 Dog Key 5/32" Pkg/10	090085	-		\$101.00	-	-	-
Cover Plate Bearing Insert	968592	-		\$19.00	-	-	-

BASEPLATE							
Description	Specify			Non-finished	689 695	526	622
	Part number	Finish					
Baseplate Bumper Pkg/4	090038	-		\$18.00	-	-	-
Baseplate Return Spring Pkg/10	090039	-		\$19.00	-	-	-
Dogging Shaft Pkg/2	090040	-		\$19.00	-	-	-
Dogging Spring Pkg/2	090041	-		\$18.00	-	-	-
Dogging Adapter Spring Pkg/2	090042	-		\$24.00	-	-	-
Dogging Adapter Pkg/2	090043	-		\$19.00	-	-	-
Dogging Hook Pkg/2	090044	-		\$19.00	-	-	-
Baseplate Bearing Strip Pkg/2	090048	-		\$19.00	-	-	-

PARTS AND ACCESSORIES

605	606	611	612	613	619	622	625	626	626AM	628	629
US3	US4	US9	US10	US10B	US15	US19	US26	US26D	US26DAM	US28	US32
630	630AM	643e	689	691	693	695	706	710	711	721	728
US32D	US32DAM	-	SP28	SP10	SPBLK	SP313	SP4	313	315	US3A	US4A

BASEPLATE

Description	Specify		Non-finished	689 695	526	622
	Part number	Finish				
22 Centercase Spacer	47289674	-	\$19.00	-	-	-

VERTICAL LATCHES

Description	Specify		Non-finished	689 695	526	622
	Part number	Finish				
2227 Bottom Latch Retrofit Kit (for devices shipped before October 1998)	050090	.[Finish]	-	\$208.00	\$243.00	\$229.00
2227 Top Latch Retrofit Kit (for devices shipped before October 1998)	050091	.[Finish]	-	\$208.00	\$243.00	\$208.00
2227 Bottom Latch Kit Less Cover (for devices shipped after October 1998)	050401	-	\$208.00	-	-	-
2227 Top Latch Kit Less Cover (for devices shipped after October 1998)	050400	-	\$208.00	-	-	-
2227 PL Latch Kit Less Cover	050402	-	\$208.00	-	-	-
2227 Latch Case Cover	050566	.[Finish]	-	\$78.00	\$90.00	\$85.00
2227 Latch Case Cover Screw Pkg	900850	.[Finish]	-	\$19.00	-	\$22.00
2227 Latch Case Mtg. Bracket Kit (for devices shipped after October 1998)	050546	-	\$42.00	-	-	-
2227 Top Latch Compression Spring Pkg/10	090056	-	\$19.00	-	-	-
2227 Top Latch Spring Pkg/10	090057	-	\$19.00	-	-	-
2227 Bolt Return Spring Pkg/10	090065	-	\$19.00	-	-	-
2227 Top Latch Aux. Bolt Spring Pkg/10	090076	-	\$19.00	-	-	-
2227 Latch Case Screw Pkg 1-3/4" Door (for devices shipped after October 1998)	900589	-	\$19.00	-	-	-

VERTICAL RODS

Description	Specify		Non-finished	689 695	526	622
	Part number	Finish				
2227 Top Vertical Rod	109361	.[Finish]	-	\$153.00	\$180.00	\$168.00
2227 Bottom Vertical Rod	109362	.[Finish]	-	\$153.00	\$180.00	\$168.00
2227 Extension Rod 36" Kit	051804	.[Finish]	-	\$42.00	\$48.00	\$46.00
2227 Rod Guide Package	112063	.[Finish]	-	\$85.00	\$89.00	\$85.00
2227 Rod Guide Mtg. Package	900919	.[Finish]	-	\$19.00	-	\$22.00
2227 Rod Connector - Latch Pkg/2	090067	-	\$30.00	-	-	-
2227 Rod Connector - Center Case Pkg/2	090068	-	\$30.00	-	-	-
2227 Top or Bottom Rod Connector	050547	-	\$17.00	-	-	-
2227 Rod Extension Connector Pkg/4	090075	-	\$20.00	-	-	-
2227 Rod Roll Pin Pkg/10	090054	-	\$20.00	-	-	-

33A/35A SERIES

605	606	611	612	613	619	622	625	626	626AM	628	629
US3	US4	US9	US10	US10B	US15	US19	US26	US26D	US26DAM	US28	US32
630	630AM	643e	689	691	693	695	706	710	711	721	728
US32D	US32DAM	-	SP28	SP10	SPBLK	SP313	SP4	313	315	US3A	US4A

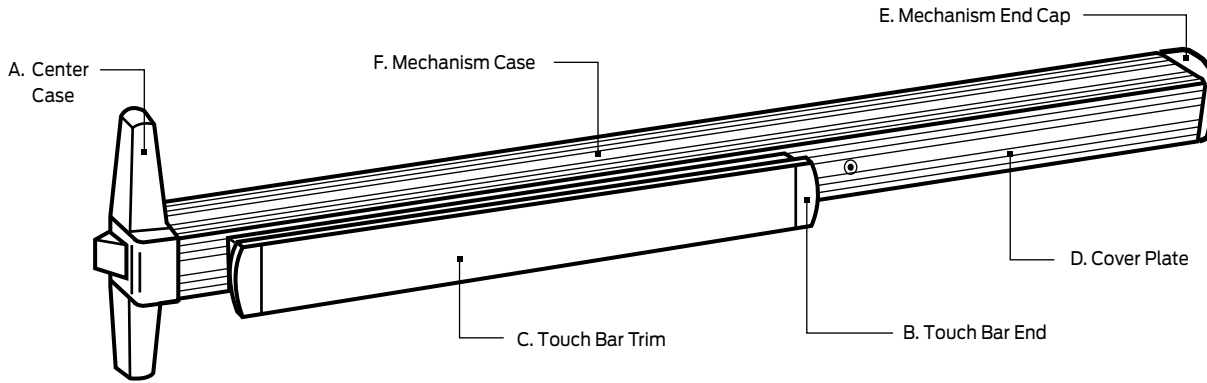

STANDARD FINISHES					
COLOR	US NUMBER	BHMA NUMBER	A, B, E	C - TOUCH BAR TRIM FINISHES	D, F
Bright Brass	US3	605	(A) Buffed Anodized (Dull) (B, E) Bright Brass	Bright Brass, 605 (US3)	Buffed Anodized
Satin Brass	US4	606	(A) Anodized (B, E) Bright Brass	Satin Brass, 606 (US4)	Anodized
Satin Bronze	US10	612	Plated/Anodized	Satin Bronze, 725 (US10)	Anodized
Satin Bronze, Oil-Rubbed	US10B	613	(A) Powder Coat (B, E) Oil-Rubbed	Oil Rubbed, 613 (US10B)	Powder Coat
Satin Nickel	US15	619	Plated, Clear Powder Coat	Satin Stainless Steel, 630 (US32D)	Anodized
Polished Chrome	US26	625	Plated	Bright Stainless Steel, 629 (US32)	Buffed Anodized
Satin Chrome	US26D	626	Plated	Satin Stainless Steel, 630 (US32D)	Anodized
Satin Chrome, Antimicrobial	US26D-AM	626AM	AM Clear over Chrome	AM Clear over Satin Stainless Steel, 630 (US32D)	AM Clear over Anodized
Anodized Aluminum	US28	628	(A, B) Anodized (E) Plated	Satin Stainless Steel, 630 (US32D)	Anodized
Duranodic Dark Bronze	313	710	Powder Coat	Powder Coat, 710 (313)	Powder Coat
Black	315	711	Powder Coat	Powder Coat, 711 (315)	Powder Coat
Aged Bronze	--	643E	(A) Aged Bronze, No Relief (B, E) Relieved Aged Bronze	Relieved Aged Bronze	Aged Bronze No Relief

619 available on 35A only

SPECIAL FINISHES					
COLOR	US NUMBER	BHMA NUMBER	A, B, E	C - TOUCH BAR TRIM FINISHES	D, F
Bright Bronze	US9	611	Plated	Bright Bronze, 611 (US9)	Buffed Anodized
Powder Coat	RAL # *	--	Powder Coat	Powder Coat	Powder Coat

* See Finish page for optional RAL color information.

33A/35A SERIES SEX BOLT QUANTITIES		
APPLICATION	425 SEX BOLTS (SUPPLIED)	FOR LATCHES 325 SEX BOLTS (SUPPLIED)
EO (exit only device)	2	4
DT device with 550 trim	2	4
NL-OP device with 388 trim	2	4
3327A or 3347A TL-OP with 374T trim	2	2

 Indicates products that have EPD documentation available and meet LEED v4.

33A/35A SERIES

605	606	611	612	613	619	622	625	626	626AM	628	629
US3	US4	US9	US10	US10B	US15	US19	US26	US26D	US26DAM	US28	US32
630	630AM	643e	689	691	693	695	706	710	711	721	728
US32D	US32DAM	-	SP28	SP10	SPBLK	SP313	SP4	313	315	US3A	US4A

TYPE OF DEVICE 33A (GROOVED) 35A (SMOOTH)			
33A or 35A Rim	3327A or 3527A Surface Vertical Rod	3347A/48A or 3547A/48A Concealed Vertical Rod	3349A or 3549A Concealed Vertical Cable
3350WDC or 3550WDC Wood Door Concealed Vertical Cable			

FUNCTION			
DT: Dummy Trim	EO: Exit Only	L: Lever, 06 Standard	LBE: Lever, Blank Escutcheon
LDT: Lever, Dummy Trim	NL: Night Latch, Key Retracts	NLOP: Night Latch, Opt. Pull	T: Thumbturn
TBE: Thumbturn - Blank Escutcheon	TL: Turn Lever	TLBE: Turn Lever, Blank Escutcheon	TLOP: Turn Lever, Opt. Pull







RATING	
None: Panic Exit Device	F: Fire Exit Device

DEVICE FINISH			
605: Bright Brass (US3)	606: Satin Brass (US4)	612: Satin Bronze (US10)	613: Satin Bronze-Oil Rubbed (US10B)
619: Satin Nickel (35A Series only, US15)	625: Bright Chrome (US26)	626: Satin Chrome (US26D)	626AM: Antimicrobial (US26D-AM)
628: Anodized Aluminum (US28)	710: Duranodic Dark Bronze (313)	711: Black (315)	

DEVICE SIZE (FEET AND INCHES)		
2ft: 2' Device for 2' Door - Vertical Device only	3ft: 3' Device for 2' 4" - 3' Door	4ft: 4' Device for 2' 10" - 4' Door

DEVICE HANDING	
RHR: Right Hand Reverse	LHR: Left Hand Reverse

TRIM / CONTROL TRIM			
LC: Less Control	LT: Less Trim	360: Lever Control	360T: Thumbturn Control - Rim
374T: Thumbturn Control - SV	376T: Thumbturn Control - CV	376TWDC: 376T for Wood Door	386: Standard DT/NL Trim
388: Night Latch Cylinder Trim	392-6: Optional Wire Pull Dummy Trim	550: Optional Offset Dummy Trim	E360: 360 Elec. Unlocking
E360T: 360T Elec. Unlocking	E374T: 374T Elec. Unlocking	E376T: 376T Elec. Unlocking	E376TWDC: 376TWDC Elec. Unlocking

CONTROL LEVER STYLES 06 LEVER STANDARD											
Standard levers:	01	02	03	05	06	07	12	16	17	18	
	ACC: Accent 		AST: Asti 		MER: Merano 		LAT: Latitude		LON: Longitude		
Knurled levers:	03K	06K									
M Collection lever:	M51	M52	M53	M54	M55	M56	M61 	M63 			
	M81	M82	M83	M84	M85 	ME1	ME2	ME3			
Stainless steel levers:	03SS	06SS	17SS	LATSS	M57	M62 					

TRIM/CONTROL FINISH			
605: Bright Brass (US3)	606: Satin Brass (US4)	612: Satin Bronze (US10)	613: Satin Bronze-Oil Rubbed (US10B)
625: Bright Chrome(US26)	626: Satin Chrome (US26D)	626AM: Antimicrobial (US26D-AM)	693: Painted Black (SPBLK)

22 SERIES
33A/35A SERIES
55 SERIES
88 SERIES
98/99 SERIES
XP98/XP99 SERIES
94/95 SERIES
GUARD-X SERIES
ACCESSORIES / PARTS
ELECTRICAL / PARTS

33A/35A SERIES

605	606	611	612	613	619	622	625	626	626AM	628	629
US3	US4	US9	US10	US10B	US15	US19	US26	US26D	US26DAM	US28	US32
630	630AM	643e	689	691	693	695	706	710	711	721	728
US32D	US32DAM	-	SP28	SP10	SPBLK	SP313	SP4	313	315	US3A	US4A

RODS FOR SURFACE / CONCEALED VERTICAL DEVICES ONLY			
LBR: Less Bottom Rod	LBRAFL: LBR with Aux. Fire Pin	OPR: 1 Piece Top Rod	
DOGGING OPTIONS			
CD: Cylinder Dogging, Panic Only	CDSI: Cylinder Dogging with Indicator	HD: Hex Dogging	HDSI: Hex Dogging with Indicator
LD: Less Dogging			
SWITCH OPTIONS			
LX: Latch Bolt Monitoring	LXLC: LBM Low Current	LXRX: LBM Request to Exit	LXRXLC: LBM Request to Exit Low Current
RX: Request to Exit	RX2: Request to Exit Double Switch	RXLC: Request to Exit Low Current	SS: Signal Switch
WPRX: Waterproof Request to Exit			
LATCH RETRACTION OPTIONS			
EL: Electric Latch Retraction	HD-QELX: Quiet electric latch retraction with hex dogging (panic only) for AX devices	PN: Pneumatic Latch Retraction	QEL: Quiet Electric Latch Retraction
QELX: Quiet electric latch retraction for AX devices	QEL-L - Quiet electric latch retraction - latchbolt only		
EMERGENCY SECURE LOCKDOWN			
ESL: Emergency Secure Lockdown			
QUIET MECHANICAL - CONTROLS MOTION TO REDUCE OPERATIONAL NOISE			
QM33/35A Rim	QM33/3527A Surface Vertical Rod		
CX DELAYED EGRESS			
CX: Chexit - Controlled Exit	CXRCM: Remote Chexit Module		
ELECTRICAL LOCKING			
ES: Pullman Latch for Electric Strike	FS: Fail Safe	FSE: Fail Secure	
STORM RATING			
HH: Wind and Impact - Hurricane Rated	HW: Wind Only - Hurricane Rated		
ACCESSIBLE DEVICE			
AX: Accessible device compliant with the California Building Code (Section 11B-309.4) requirement for 5 lb. maximum operational force.			
STRIKE SERIES			
LS: Less Strike	LTS: Less Top Strike	1410: Optional Rim	1439: Standard Rim
1439F: Optional Rim Fire	150: Standard CVC-WDC	1606: Optional Rim	1609: Optional Rim
249: Standard CVC	260U: Optional SV Flush Transom	260UF: Option SV Fire Flush Transom	264: Optional Rim or SV
266: Standard SV	283: Optional CV - Wood Frame	299: Optional Rim	299F: Standard SV Fire
338: Standard CV	499F: Standard SV Fire LBR		

605	606	611	612	613	619	622	625	626	626AM	628	629
US3	US4	US9	US10	US10B	US15	US19	US26	US26D	US26DAM	US28	US32
630	630AM	643e	689	691	693	695	706	710	711	721	728
US32D	US32DAM	-	SP28	SP10	SPBLK	SP313	SP4	313	315	US3A	US4A

BOTTOM STRIKE SERIES

LBS: Less Bottom Strike	248L4: Surface	304L: Mortise	349: Standard CVC
385A: Adjustable Mortise	450: Standard CVC-WDC		

ELECTRIC / MONITOR STRIKE

OTH: Other Mfg Strike	4263T1: Rim monitor strike	4263T1: Rim monitor strike	4690-1T2: for 33/3547A Non - Fire
4690T2: for 33/3547A-F	6111: Rim with Mullion 33/3527A LBR	6112: 33/35A Rim single door	6113: 33/35A Rim single door
6114: 33/35A Rim NL function	6121: 33/35A Rim double door no mullion	6213: Used with 33/3547A LBR	

STRIKE FINISH

605: Bright Brass (US3)	606: Satin Brass (US4)	612: Satin Bronze (US10)	613: Satin Bronze-Oil Rubbed (US10B)
625: Bright Chrome(US26)	626: Satin Chrome (US26D)	629: Bright Stainless (US32)	630: Satin Stainless (US32D)
691: Satin Bronze (SP10)	695: Duranodic Dark Bronze (313)	711: Flat Black (US19)	

TOUCH BAR TRIM OPTIONS

BR: Braille	EMB: Embossed "Push"	KN: Knurled	RSS: Emergency Exit (630 only)
SG: Safety Glow			

DRAINAGE / WEEP HOLES

WH: Drainage/Weep Holes in Mechanism Case (3' device will have 5 holes, 6" spacing; 4' device will have 7 holes, 6" spacing)

CX DELAYED EGRESS RELEASE DELAY

OSEC: 0 second delay	15SEC: 15 second delay	INFDEL: Infinite delay	M15SEC: 15 second mute delay
BOCA15SEC: BOCA 15 second delay	BOCA30SEC: BOCA 30 second delay		

MISC DEVICE OPTIONS

CE: CE Label	10WDA: WDA cover plate	33AWDA: 33A WDA cover plate	50WDC: 50WDC cover plate
ALK: Standard Alarm Kit	CYL: Include Cylinder	LCP: Less cover plate	PL: Include Pullman Latch

CONNECTOR

CON: Connectors

SECURITY SCREWS

SEC: Include Security Screws

GBK/SHIM KIT/RISES

GBK: Include GBK

DOOR THICKNESS

DT1-3/4: 1-3/4" Standard	DT2: 2" thickness	DT2-1/4: 2-1/4" thickness
--------------------------	-------------------	---------------------------

605	606	611	612	613	619	622	625	626	626AM	628	629
US3	US4	US9	US10	US10B	US15	US19	US26	US26D	US26DAM	US28	US32
630	630AM	643e	689	691	693	695	706	710	711	721	728
US32D	US32DAM	-	SP28	SP10	SPBLK	SP313	SP4	313	315	US3A	US4A

DOOR MATERIAL

ALD: Aluminum door	CP: Composite door	HMD: Hollow metal	WD: Wood door
INS2: Insulclad - 1/2"	INS4: Insulclad - 1/4"		

FRAME MATERIAL

ALF: Aluminum Frame	HMF: Hollow Metal Frame	WDF: Wood Frame
---------------------	-------------------------	-----------------

DOOR MODE/APPLICATION

DE: Pair Double egress doors	PR: Pair of doors	SGL: Single door
------------------------------	-------------------	------------------

MULLION APPLICATION

1654: Hollow metal (HM) used with 2 - 1606 strikes	4754: Hollow metal (HM) used with 2 - 4263 monitor strikes	5654: Aluminum (AL) used with 2 - 299 strikes
4954: Hollow metal (HM) used with 2 - 299/264 strikes	4854: Hollow metal (HM) used with a 299 and 6111ES	5754: Aluminum (AL) 1408 strike installed

APPLICATION NOTE FOR 2' DEVICE

Available on Surface and Concealed Vertical (panic and fire).

When vertical rod devices are used on both doors of a pair, operation of the inactive door (smaller door) will not disengage the active door, creating a potential safety issue for those using the inactive door during an emergency. In addition, standard hex or cylinder dogging is not available. Dogging is not available for this application on 33/3527A/47/49A/50A-WDC devices.

For pairs of doors using one 2' door Von Duprin recommends the following hardware combinations listed below for optimum safety in an emergency.

1. Surface or Concealed Vertical device on the 2' door (inactive) and a mortise device on the larger door (active). This combination is used primarily on Hollow Metal door applications only.
2. Automatic Flush Bolt on the 2' door (inactive) and a Surface or Concealed Vertical device on the larger door (active).

Note: The 2' door width is not available with any electrical, Chexit, hurricane or windstorm options.

605	606	611	612	613	619	622	625	626	626AM	628	629
US3	US4	US9	US10	US10B	US15	US19	US26	US26D	US26DAM	US28	US32
630	630AM	643e	689	691	693	695	706	710	711	721	728
US32D	US32DAM	-	SP28	SP10	SPBLK	SP313	SP4	313	315	US3A	US4A

33A/35A SERIES

Rim devices

ACN							PRICE BASED ON FINISH						Default trim, included		
Device type	Function	Fire	Finish	Device size	Handing	Lever design	626	628	710 ¹	612	606 ²	643E		711	613 ³
EXIT HARDWARE							3' DEVICE PRICING SHOWN. 2' ADD \$104.00 LIST, 4' ADD \$26.00 LIST								
[33A/35A]	EO	.	[]	.	[]		\$2,447	\$1,996	\$2,001	\$2,068	\$2,068	\$2,562	\$3,064	\$2,417	N/A
[33A/35A]	DT	.	[]	.	[]		\$2,941	\$2,490	\$2,495	\$2,760	\$2,562	\$3,179	\$3,558	\$2,911	386DT
[33A/35A]	NL	.	[]	.	[]	.	\$3,324	\$2,873	\$2,878	\$3,143	\$2,945	\$3,562	\$3,941	\$3,294	386NL ⁴
[33A/35A]	NL-OP	.	[]	.	[]		\$2,881	\$2,430	\$2,435	\$2,691	\$2,473	\$2,996	\$3,469	\$2,851	388
[33A/35A]	L	.	[]	.	[]	.	\$3,413	\$2,962	\$2,997	\$3,107	\$2,992	\$3,637	\$4,060	\$3,413	360L ⁴
[33A/35A]	L-BE	.	[]	.	[]	.	\$3,349	\$2,898	\$2,933	\$3,043	\$2,928	\$3,573	\$3,996	\$3,349	360L-BE ⁴
[33A/35A]	L-DT	.	[]	.	[]	.	\$3,338	\$2,887	\$2,922	\$3,032	\$2,917	\$3,562	\$3,985	\$3,338	360L-DT ⁴
[33A/35A]	TL	.	[]	.	[]		\$3,493	\$3,042	\$3,047	\$3,194	\$2,969	\$3,688	\$4,110	\$3,463	360T ⁴
[33A/35A]	TL-BE	.	[]	.	[]		\$3,436	\$2,985	\$2,990	\$3,137	\$2,912	\$3,631	\$4,053	\$3,406	360T-BE ⁴
[33A/35A]	T	.	[]	.	[]		\$3,493	\$3,042	\$3,047	\$3,194	\$2,969	\$3,688	\$4,110	\$3,463	360T ⁴
[33A/35A]	T-BE	.	[]	.	[]		\$3,436	\$2,985	\$2,990	\$3,137	\$2,912	\$3,631	\$4,053	\$3,406	360T-BE ⁴
FIRE EXIT HARDWARE							3' DEVICE PRICING SHOWN. 2' ADD \$104.00 LIST, 4' ADD \$26.00 LIST								
[33A/35A]	EO	.	F	.	[]	.	\$2,483	\$2,032	\$2,037	\$2,104	\$2,104	\$2,598	\$3,100	\$2,453	N/A
[33A/35A]	DT	.	F	.	[]	.	\$2,977	\$2,526	\$2,531	\$2,796	\$2,598	\$3,215	\$3,594	\$2,947	386DT
[33A/35A]	NL	.	F	.	[]	.	\$3,360	\$2,909	\$2,914	\$3,179	\$2,981	\$3,598	\$3,977	\$3,330	386NL ⁴
[33A/35A]	NL-OP	.	F	.	[]	.	\$2,917	\$2,466	\$2,471	\$2,727	\$2,509	\$3,032	\$3,505	\$2,887	388
[33A/35A]	L	.	F	.	[]	.	\$3,449	\$2,998	\$3,033	\$3,143	\$3,028	\$3,673	\$4,096	\$3,449	360L ⁴
[33A/35A]	L-BE	.	F	.	[]	.	\$3,385	\$2,934	\$2,969	\$3,079	\$2,964	\$3,609	\$4,032	\$3,385	360L-BE ⁴
[33A/35A]	TL	.	F	.	[]	.	\$3,529	\$3,078	\$3,083	\$3,230	\$3,005	\$3,724	\$4,146	\$3,499	360T ⁴
[33A/35A]	TL-BE	.	F	.	[]	.	\$3,472	\$3,021	\$3,026	\$3,173	\$2,948	\$3,667	\$4,089	\$3,442	360T-BE ⁴
[33A/35A]	T	.	F	.	[]	.	\$3,529	\$3,078	\$3,083	\$3,230	\$3,005	\$3,724	\$4,146	\$3,499	360T ⁴
[33A/35A]	T-BE	.	F	.	[]	.	\$3,472	\$3,021	\$3,026	\$3,173	\$2,948	\$3,667	\$4,089	\$3,442	360T-BE ⁴

² Consult factory for lead time

⁴ 386NL Series trim is handed and not field reversible. Please specify handing, RHR or LHR.

¹ Devices in 710 finish are furnished with 695 trims by default

² 619 finish available only on 35A Series

³ 613 finish has 710 finish device with 695 parts

⁴ Wood Doors - 33A-WDA cover plate is required for the 360 series control and will be supplied at an additional, \$75.00 list add.

DEFAULT ATTRIBUTES

Pricing includes default options shown below. Additional options and configurations available.

Cylinders:	Sex bolts	Door thickness	Center line
Not included	Included	1-3/4"	39-13/16"

Strike(s):

Exit hardware:

- ALF applications: Includes 1439 strike
- HMF and WDF applications: 299 strike is supplied at a -\$122.00 list deduct

Fire exit hardware:

- Single door applications: Includes 299F strike
- Double door applications: 499F strike will be supplied at an additional \$150.00 list add

33A/35A SERIES

605	606	611	612	613	619	622	625	626	626AM	628	629
US3	US4	US9	US10	US10B	US15	US19	US26	US26D	US26DAM	US28	US32
630	630AM	643e	689	691	693	695	706	710	711	721	728
US32D	US32DAM	-	SP28	SP10	SPBLK	SP313	SP4	313	315	US3A	US4A

Surface vertical rod devices (27A)

ACN							PRICE BASED ON FINISH							Default trim, included									
Device type	Function	Fire	Finish	Device size	Handing	Lever design	626	628	710 ¹	612	606 ²	605 ²	619 ²		625	643E	711	613 ³					
							3' DEVICE PRICING SHOWN. 2' ADD \$104.00 LIST, 4' ADD \$26.00 LIST																
EXIT HARDWARE							3' DEVICE PRICING SHOWN. 2' ADD \$104.00 LIST, 4' ADD \$26.00 LIST																
[33/35]27A . EO . [] . [] .							\$3,474	\$2,947	\$3,005	\$3,075	\$3,072	\$3,599	\$4,229	\$3,659				N/A					
[33/35]27A . DT . [] . [] .							\$3,968	\$3,441	\$3,499	\$3,767	\$3,566	\$4,216	\$4,723	\$4,153				386DT					
[33/35]27A . NL . [] . [] . []							\$4,351	\$3,824	\$3,882	\$4,150	\$3,949	\$4,599	\$5,106	\$4,536				386NL ⁴					
[33/35]27A . NL-OP . [] . [] .							\$3,908	\$3,381	\$3,439	\$3,698	\$3,477	\$4,033	\$4,634	\$4,093				388					
[33/35]27A . L . [] . [] . [] . []							\$4,440	\$3,913	\$4,001	\$4,114	\$3,996	\$4,674	\$5,225	\$4,655				360L ⁴					
[33/35]27A . L-BE . [] . [] . [] . []							\$4,376	\$3,849	\$3,937	\$4,050	\$3,932	\$4,610	\$5,161	\$4,591				360L-BE ⁴					
[33/35]27A . L-DT . [] . [] . [] . []							\$4,365	\$3,838	\$3,926	\$4,039	\$3,921	\$4,599	\$5,150	\$4,580				360L-DT ⁴					
[33/35]27A . TL . [] . [] .							\$5,014	\$4,487	\$4,545	\$4,893	\$4,467	\$5,342	\$5,769	\$5,199				386DT/374T					
[33/35]27A . TL-BE . [] . [] .							\$4,957	\$4,430	\$4,488	\$4,836	\$4,410	\$5,285	\$5,712	\$5,142				386DT/374T-BE					
[33/35]27A . T . [] . [] .							\$4,520	\$3,993	\$4,051	\$4,201	\$3,973	\$4,725	\$5,275	\$4,705				360T ⁴					
[33/35]27A . T-BE . [] . [] .							\$4,463	\$3,936	\$3,994	\$4,144	\$3,916	\$4,668	\$5,218	\$4,648				360T-BE ⁴					
FIRE EXIT HARDWARE							3' DEVICE PRICING SHOWN. 2' ADD \$104.00 LIST, 4' ADD \$26.00 LIST																
[33/35]27A . EO . F . [] . []							\$3,509	\$2,982	\$3,040	\$3,110	\$3,107	\$3,634	\$4,264	\$3,694				N/A					
[33/35]27A . DT . F . [] . []							\$4,003	\$3,476	\$3,534	\$3,802	\$3,601	\$4,251	\$4,758	\$4,188				386DT					
[33/35]27A . NL . F . [] . [] . []							\$4,386	\$3,859	\$3,917	\$4,185	\$3,984	\$4,634	\$5,141	\$4,571				386NL ⁴					
[33/35]27A . NL-OP . F . [] . []							\$3,943	\$3,416	\$3,474	\$3,733	\$3,512	\$4,068	\$4,669	\$4,128				388					
[33/35]27A . L . F . [] . [] . [] . []							\$4,475	\$3,948	\$4,036	\$4,149	\$4,031	\$4,709	\$5,260	\$4,690				360L ⁴					
[33/35]27A . L-BE . F . [] . [] . [] . []							\$4,411	\$3,884	\$3,972	\$4,085	\$3,967	\$4,645	\$5,196	\$4,626				360L-BE ⁴					
[33/35]27A . TL . F . [] . []							\$5,049	\$4,522	\$4,580	\$4,928	\$4,502	\$5,377	\$5,804	\$5,234				386DT/374T					
[33/35]27A . TL-BE . F . [] . []							\$4,992	\$4,465	\$4,523	\$4,871	\$4,445	\$5,320	\$5,747	\$5,177				386DT/374T-BE					
[33/35]27A . T . F . [] . []							\$4,555	\$4,028	\$4,086	\$4,236	\$4,008	\$4,760	\$5,310	\$4,740				360T ⁴					
[33/35]27A . T-BE . F . [] . []							\$4,498	\$3,971	\$4,029	\$4,179	\$3,951	\$4,703	\$5,253	\$4,683				360T-BE ⁴					

- ☒ Consult factory for lead time
- ☞ 386NL Series trim is handed and not field reversible. Please specify handing, RHR or LHR.
- ¹ Devices in 710 finish are furnished with 695 trims by default
- ² 619 finish available only on 35A Series
- ³ 613 finish has 710 finish device with 613 parts
- ⁴ Wood Doors - 33A-WDA cover plate is required for the 360 series control and will be supplied at an additional, \$75.00 list add.

DEFAULT ATTRIBUTES

Pricing includes default options shown below. Additional options and configurations available.

Cylinders:	Sex bolts	Door thickness	Center line
Not included	Included	1-3/4"	39-13/16"

Strike(s):

- Exit hardware:
 - Includes 266, 248L-4 and 304L strikes
- Fire exit hardware:
 - Includes 299F and 304L strikes

605	606	611	612	613	619	622	625	626	626AM	628	629
US3	US4	US9	US10	US10B	US15	US19	US26	US26D	US26DAM	US28	US32
630	630AM	643e	689	691	693	695	706	710	711	721	728
US32D	US32DAM	-	SP28	SP10	SPBLK	SP313	SP4	313	315	US3A	US4A

33A/35A SERIES

Concealed vertical rod devices (47A)

ACN							PRICE BASED ON FINISH							Default trim, included	
Device type	Function	Fire	Finish	Device size	Handing	Lever design	626	628	710 ¹	612	606 ²	605 ² 619 ² 625 643E	711		613 ³
EXIT HARDWARE							3' DEVICE PRICING SHOWN. 2' ADD \$104.00 LIST, 4' ADD \$26.00 LIST								
[33/35]47A	. EO	.	[]	[]	.		\$3,467	\$2,940	\$2,998	\$3,068	\$3,065	\$3,592	\$4,222	\$3,652	N/A
[33/35]47A	. DT	.	[]	[]	.		\$3,961	\$3,434	\$3,492	\$3,760	\$3,559	\$4,209	\$4,716	\$4,146	386DT
[33/35]47A	. NL	.	[]	[]	[]		\$4,344	\$3,817	\$3,875	\$4,143	\$3,942	\$4,592	\$5,099	\$4,529	386NL ⁴
[33/35]47A	. NL-OP	.	[]	[]	.		\$3,901	\$3,374	\$3,432	\$3,691	\$3,470	\$4,026	\$4,627	\$4,086	388
[33/35]47A	. L	.	[]	[]	[]	[]	\$4,433	\$3,906	\$3,994	\$4,107	\$3,989	\$4,667	\$5,218	\$4,648	360L ⁴
[33/35]47A	. L-BE	.	[]	[]	[]	[]	\$4,369	\$3,842	\$3,930	\$4,043	\$3,925	\$4,603	\$5,154	\$4,584	360L-BE ⁴
[33/35]47A	. L-DT	.	[]	[]	[]	[]	\$4,358	\$3,831	\$3,919	\$4,032	\$3,914	\$4,592	\$5,143	\$4,573	360L-DT ⁴
[33/35]47A	. TL	.	[]	[]	.		\$5,007	\$4,480	\$4,538	\$4,886	\$4,460	\$5,335	\$5,762	\$5,192	386DT/376T
[33/35]47A	. TL-BE	.	[]	[]	.		\$4,950	\$4,423	\$4,481	\$4,829	\$4,403	\$5,278	\$5,705	\$5,135	386DT/376T-BE
[33/35]47A	. T	.	[]	[]	.		\$4,513	\$3,986	\$4,044	\$4,194	\$3,966	\$4,718	\$5,268	\$4,698	360T ⁴
[33/35]47A	. T-BE	.	[]	[]	.		\$4,456	\$3,929	\$3,987	\$4,137	\$3,909	\$4,661	\$5,211	\$4,641	360T-BE ⁴
FIRE EXIT HARDWARE							3' DEVICE PRICING SHOWN. 2' ADD \$104.00 LIST, 4' ADD \$26.00 LIST								
[33/35]47A	. EO	. F	[]	[]	[]		\$3,659	\$3,132	\$3,190	\$3,260	\$3,257	\$3,784	\$4,414	\$3,844	N/A
[33/35]47A	. DT	. F	[]	[]	[]		\$4,153	\$3,626	\$3,684	\$3,952	\$3,751	\$4,401	\$4,908	\$4,338	386DT
[33/35]47A	. NL	. F	[]	[]	[]		\$4,536	\$4,009	\$4,067	\$4,335	\$4,134	\$4,784	\$5,291	\$4,721	386NL ⁴
[33/35]47A	. NL-OP	. F	[]	[]	[]		\$4,093	\$3,566	\$3,624	\$3,883	\$3,662	\$4,218	\$4,819	\$4,278	388
[33/35]47A	. L	. F	[]	[]	[]	[]	\$4,625	\$4,098	\$4,186	\$4,299	\$4,181	\$4,859	\$5,410	\$4,840	360L ⁴
[33/35]47A	. L-BE	. F	[]	[]	[]	[]	\$4,561	\$4,034	\$4,122	\$4,235	\$4,117	\$4,795	\$5,346	\$4,776	360L-BE ⁴
[33/35]47A	. TL	. F	[]	[]	[]		\$5,199	\$4,672	\$4,730	\$5,078	\$4,652	\$5,527	\$5,954	\$5,384	386DT/376T
[33/35]47A	. TL-BE	. F	[]	[]	[]		\$5,142	\$4,615	\$4,673	\$5,021	\$4,595	\$5,470	\$5,897	\$5,327	386DT/376T-BE
[33/35]47A	. T	. F	[]	[]	[]		\$4,705	\$4,178	\$4,236	\$4,386	\$4,158	\$4,910	\$5,460	\$4,890	360T ⁴
[33/35]47A	. T-BE	. F	[]	[]	[]		\$4,648	\$4,121	\$4,179	\$4,329	\$4,101	\$4,853	\$5,403	\$4,833	360T-BE ⁴

- ² Consult factory for lead time
- ⁴ 386NL Series trim is handed and not field reversible. Please specify handing, RHR or LHR.
- ¹ Devices in 710 finish are furnished with 695 trims by default
- ² 619 finish available only on 35A Series
- ³ 613 finish has 710 finish device with 613 parts
- ⁴ Wood Doors - 33A-WDA cover plate is required for the 360 series control and will be supplied at an additional, \$75.00 list add.

DEFAULT ATTRIBUTES

Pricing includes default options shown below. Additional options and configurations available.

Cylinders:	Sex bolts	Door thickness	Center line
Not included	Included	1-3/4"	39-13/16"

Strike(s):

- Exit hardware:
 - Includes 338 and 385A strikes
- Fire exit hardware:
 - Includes 338 and 385A strikes

33A/35A SERIES

605	606	611	612	613	619	622	625	626	626AM	628	629
US3	US4	US9	US10	US10B	US15	US19	US26	US26D	US26DAM	US28	US32
630	630AM	643e	689	691	693	695	706	710	711	721	728
US32D	US32DAM	-	SP28	SP10	SPBLK	SP313	SP4	313	315	US3A	US4A

Concealed vertical rod devices for hollow metal doors (48A)

ACN							PRICE BASED ON FINISH							Default trim, included	
Device type	Function	Fire	Finish	Device size	Handing	Lever design									
							626	628	710 ¹	612	606 ²	605 ² 619 ² 625 643E	711		613 ³
EXIT HARDWARE							3' DEVICE PRICING SHOWN. 2' ADD \$104.00 LIST, 4' ADD \$26.00 LIST								
[33/35]48A	. EO	.	[] . [] .				\$3,882	\$3,355	\$3,413	\$3,483	\$3,480	\$4,007	\$4,637	\$4,067	N/A
[33/35]48A	. DT	.	[] . [] .				\$4,376	\$3,849	\$3,907	\$4,175	\$3,974	\$4,624	\$5,131	\$4,561	386DT
[33/35]48A	. NL	.	[] . [] . []				\$4,759	\$4,232	\$4,290	\$4,558	\$4,357	\$5,007	\$5,514	\$4,944	386NL ⁴
[33/35]48A	. NL-OP	.	[] . [] .				\$4,316	\$3,789	\$3,847	\$4,106	\$3,885	\$4,441	\$5,042	\$4,501	388
[33/35]48A	. L	.	[] . [] . [] . []				\$4,848	\$4,321	\$4,409	\$4,522	\$4,404	\$5,082	\$5,633	\$5,063	360L
[33/35]48A	. L-BE	.	[] . [] . [] . []				\$4,784	\$4,257	\$4,345	\$4,458	\$4,340	\$5,018	\$5,569	\$4,999	360L-BE
[33/35]48A	. L-DT	.	[] . [] . [] . []				\$4,773	\$4,246	\$4,334	\$4,447	\$4,329	\$5,007	\$5,558	\$4,988	360L-DT
[33/35]48A	. TL	.	[] . [] .				\$5,422	\$4,895	\$4,953	\$5,301	\$4,875	\$5,750	\$6,177	\$5,607	386DT/376T
[33/35]48A	. TL-BE	.	[] . [] .				\$5,365	\$4,838	\$4,896	\$5,244	\$4,818	\$5,693	\$6,120	\$5,550	386DT/376T-BE
[33/35]48A	. T	.	[] . [] .				\$4,928	\$4,401	\$4,459	\$4,609	\$4,381	\$5,133	\$5,683	\$5,113	360T
[33/35]48A	. T-BE	.	[] . [] .				\$4,871	\$4,344	\$4,402	\$4,552	\$4,324	\$5,076	\$5,626	\$5,056	360T-BE
FIRE EXIT HARDWARE							3' DEVICE PRICING SHOWN. 2' ADD \$104.00 LIST, 4' ADD \$26.00 LIST								
[33/35]48A	. EO	. F	[] . []				\$4,066	\$3,539	\$3,597	\$3,667	\$3,664	\$4,191	\$4,821	\$4,251	N/A
[33/35]48A	. DT	. F	[] . []				\$4,560	\$4,033	\$4,091	\$4,359	\$4,158	\$4,808	\$5,315	\$4,745	386DT
[33/35]48A	. NL	. F	[] . [] . []				\$4,943	\$4,416	\$4,474	\$4,742	\$4,541	\$5,191	\$5,698	\$5,128	386NL ⁴
[33/35]48A	. NL-OP	. F	[] . []				\$4,500	\$3,973	\$4,031	\$4,290	\$4,069	\$4,625	\$5,226	\$4,685	388
[33/35]48A	. L	. F	[] . [] . [] . []				\$5,032	\$4,505	\$4,593	\$4,706	\$4,588	\$5,266	\$5,817	\$5,247	360L
[33/35]48A	. L-BE	. F	[] . [] . [] . []				\$4,968	\$4,441	\$4,529	\$4,642	\$4,524	\$5,202	\$5,753	\$5,183	360L-BE
[33/35]48A	. L-DT	. F	[] . [] . [] . []				\$4,957	\$4,430	\$4,518	\$4,631	\$4,513	\$5,191	\$5,742	\$5,172	360L-DT
[33/35]48A	. TL	. F	[] . []				\$5,606	\$5,079	\$5,137	\$5,485	\$5,059	\$5,934	\$6,361	\$5,791	386DT/376T
[33/35]48A	. TL-BE	. F	[] . []				\$5,549	\$5,022	\$5,080	\$5,428	\$5,002	\$5,877	\$6,304	\$5,734	386DT/376T-BE
[33/35]48A	. T	. F	[] . []				\$5,112	\$4,585	\$4,643	\$4,793	\$4,565	\$5,317	\$5,867	\$5,297	360T
[33/35]48A	. T-BE	. F	[] . []				\$5,055	\$4,528	\$4,586	\$4,736	\$4,508	\$5,260	\$5,810	\$5,240	360T-BE

- ² Consult factory for lead time
- ⁴ 386NL Series trim is handed and not field reversible. Please specify handing, RHR or LHR.
- ¹ Devices in 710 finish are furnished with 695 trims by default
- ² 619 finish available only on 35A Series
- ³ 613 finish has 710 finish device with 613 parts

DEFAULT ATTRIBUTES

Pricing includes default options shown below. Additional options and configurations available.

Cylinders:	Sex bolts	Door thickness	Center line
Not included	Included	1-3/4"	39-13/16"

Strike(s):

- Exit hardware:
- Includes 338 and 385A strikes
- Fire exit hardware:
- Includes 338 and 385A strikes

605	606	611	612	613	619	622	625	626	626AM	628	629
US3	US4	US9	US10	US10B	US15	US19	US26	US26D	US26DAM	US28	US32
630	630AM	643e	689	691	693	695	706	710	711	721	728
US32D	US32DAM	-	SP28	SP10	SPBLK	SP313	SP4	313	315	US3A	US4A

33A/35A SERIES

Concealed vertical cable devices for hollow metal doors (49A)

Prices shown are for door opening heights 6'0" -10'0"

ACN							PRICE BASED ON FINISH						Default trim, included		
Device type	Function	Fire	Finish	Device size	Handing	Lever design	626	628	710 ¹	612	606 ²	605 ² 619 ² 625 643E		711	613 ³
EXIT HARDWARE							3' DEVICE PRICING SHOWN. 2' ADD \$104.00 LIST, 4' ADD \$26.00 LIST								
[33/35]49A	EO		[] . [] .				\$3,477	\$2,950	\$3,008	\$3,078	\$3,075	\$3,602	\$4,232	\$3,662	N/A
[33/35]49A	DT		[] . [] .				\$3,971	\$3,444	\$3,502	\$3,770	\$3,569	\$4,219	\$4,726	\$4,156	386DT
[33/35]49A	NL		[] . [] . []				\$4,354	\$3,827	\$3,885	\$4,153	\$3,952	\$4,602	\$5,109	\$4,539	386NL ⁴
[33/35]49A	NL-OP		[] . [] .				\$3,911	\$3,384	\$3,442	\$3,701	\$3,480	\$4,036	\$4,637	\$4,096	388
[33/35]49A	L		[] . [] . [] . []				\$4,443	\$3,916	\$4,004	\$4,117	\$3,999	\$4,677	\$5,228	\$4,658	360L
[33/35]49A	L-BE		[] . [] . [] . []				\$4,379	\$3,852	\$3,940	\$4,053	\$3,935	\$4,613	\$5,164	\$4,594	360L-BE
[33/35]49A	L-DT		[] . [] . [] . []				\$4,368	\$3,841	\$3,929	\$4,042	\$3,924	\$4,602	\$5,153	\$4,583	360L-DT
[33/35]49A	T		[] . [] .				\$4,523	\$3,996	\$4,054	\$4,204	\$3,976	\$4,728	\$5,278	\$4,708	360T
[33/35]49A	T-BE		[] . [] .				\$4,466	\$3,939	\$3,997	\$4,147	\$3,919	\$4,671	\$5,221	\$4,651	360T-BE
FIRE EXIT HARDWARE							3' DEVICE PRICING SHOWN. 2' ADD \$104.00 LIST, 4' ADD \$26.00 LIST								
[33/35]49A	EO	F	[] . []				\$3,624	\$3,097	\$3,155	\$3,225	\$3,222	\$3,749	\$4,379	\$3,809	N/A
[33/35]49A	DT	F	[] . []				\$4,118	\$3,591	\$3,649	\$3,917	\$3,716	\$4,366	\$4,873	\$4,303	386DT
[33/35]49A	NL	F	[] . [] . []				\$4,501	\$3,974	\$4,032	\$4,300	\$4,099	\$4,749	\$5,256	\$4,686	386NL ⁴
[33/35]49A	NL-OP	F	[] . []				\$4,058	\$3,531	\$3,589	\$3,848	\$3,627	\$4,183	\$4,784	\$4,243	388
[33/35]49A	L	F	[] . [] . [] . []				\$4,590	\$4,063	\$4,151	\$4,264	\$4,146	\$4,824	\$5,375	\$4,805	360L
[33/35]49A	L-BE	F	[] . [] . [] . []				\$4,526	\$3,999	\$4,087	\$4,200	\$4,082	\$4,760	\$5,311	\$4,741	360L-BE
[33/35]49A	T	F	[] . []				\$4,670	\$4,143	\$4,201	\$4,351	\$4,123	\$4,875	\$5,425	\$4,855	360T
[33/35]49A	T-BE	F	[] . []				\$4,613	\$4,086	\$4,144	\$4,294	\$4,066	\$4,818	\$5,368	\$4,798	360T-BE

For Devices Less Cable System (LCS) Deduct -\$1,385.00

- ² Consult factory for lead time
- ⁴ 386NL Series trim is handed and not field reversible. Please specify handing, RHR or LHR.
- ¹ Devices in 710 finish are furnished with 695 trims by default
- ² 619 finish available only on 35A Series
- ³ 613 finish has 710 finish device with 613 parts

DEFAULT ATTRIBUTES

Pricing includes default options shown below. Additional options and configurations available.

Cylinders:	Sex bolts	Door thickness	Door opening height
Not included	Included	1-3/4"	6'10' - 8'
			Specify door opening height if other than 6'10' - 8'.
			For door opening heights more than 10', consult factory

Strike(s):

- Exit hardware:
 - Includes 249 and 349 Strikes
- Fire exit hardware:
 - Includes 249 and 349 Strikes

33A/35A SERIES

605	606	611	612	613	619	622	625	626	626AM	628	629
US3	US4	US9	US10	US10B	US15	US19	US26	US26D	US26DAM	US28	US32
630	630AM	643e	689	691	693	695	706	710	711	721	728
US32D	US32DAM	-	SP28	SP10	SPBLK	SP313	SP4	313	315	US3A	US4A

Wood door concealed vertical cable devices (50A-WDC)

Prices shown are for door opening heights 6'0" -10'0"

ACN								PRICE BASED ON FINISH						Default trim, included		
Device type	Function	Fire	Finish	Device size	Door height	Handing	Lever design	626	628	710 ¹	612	606 ²	605 ² 619 ² 625 643E		711	613 ³
EXIT HARDWARE								3' DEVICE PRICING SHOWN. 2' ADD \$104.00 LIST, 4' ADD \$26.00 LIST								
[33/35]50A-WDC	EO	.	[]	[]	[]	[]		\$3,480	\$3,159	\$3,388	\$3,509	\$3,619	\$3,859	\$4,354	\$4,153	N/A
[33/35]50A-WDC	DT	.	[]	[]	[]	[]		\$3,974	\$3,653	\$3,882	\$4,201	\$4,113	\$4,476	\$4,848	\$4,647	386DT
[33/35]50A-WDC	NL	.	[]	[]	[]	[]	[]	\$4,357	\$4,036	\$4,265	\$4,584	\$4,496	\$4,859	\$5,231	\$5,030	386NL
[33/35]50A-WDC	NL-OP	.	[]	[]	[]	[]		\$3,914	\$3,593	\$3,822	\$4,132	\$4,024	\$4,293	\$4,759	\$4,587	388
[33/35]50A-WDC	L	.	[]	[]	[]	[]	[]	\$4,521	\$4,200	\$4,459	\$4,623	\$4,618	\$5,009	\$5,425	\$5,224	360L/33A-WDA ⁴
[33/35]50A-WDC	L-BE	.	[]	[]	[]	[]	[]	\$4,457	\$4,136	\$4,395	\$4,559	\$4,554	\$4,945	\$5,361	\$5,160	360L-BE/33A-WDA ⁴
[33/35]50A-WDC	L-DT	.	[]	[]	[]	[]	[]	\$4,446	\$4,125	\$4,384	\$4,548	\$4,543	\$4,934	\$5,350	\$5,149	360L-DT/33A-WDA ⁴
[33/35]50A-WDC	T	.	[]	[]	[]	[]		\$4,601	\$4,280	\$4,509	\$4,710	\$4,595	\$5,060	\$5,475	\$5,274	360T/33A-WDA ⁴
[33/35]50A-WDC	T-BE	.	[]	[]	[]	[]		\$4,544	\$4,223	\$4,452	\$4,653	\$4,538	\$5,003	\$5,418	\$5,217	360T-BE/33A-WDA ⁴

For Devices Less Cable System (LCS) Deduct **-\$1,586.00**

FIRE EXIT HARDWARE								3' DEVICE PRICING SHOWN. 2' ADD \$104.00 LIST, 4' ADD \$26.00 LIST								
[33/35]50A-WDC	EO	.	F	[]	[]	[]		\$3,898	\$3,577	\$3,806	\$3,927	\$4,037	\$4,277	\$4,772	\$4,571	N/A
[33/35]50A-WDC	DT	.	F	[]	[]	[]		\$4,392	\$4,071	\$4,300	\$4,619	\$4,531	\$4,894	\$5,266	\$5,065	386DT
[33/35]50A-WDC	NL	.	F	[]	[]	[]	[]	\$4,775	\$4,454	\$4,683	\$5,002	\$4,914	\$5,277	\$5,649	\$5,448	386NL
[33/35]50A-WDC	NL-OP	.	F	[]	[]	[]		\$4,332	\$4,011	\$4,240	\$4,550	\$4,442	\$4,711	\$5,177	\$5,005	388
[33/35]50A-WDC	L	.	F	[]	[]	[]	[]	\$4,939	\$4,618	\$4,877	\$5,041	\$5,036	\$5,427	\$5,843	\$5,642	360L/33A-WDA
[33/35]50A-WDC	L-BE	.	F	[]	[]	[]	[]	\$4,875	\$4,554	\$4,813	\$4,977	\$4,972	\$5,363	\$5,779	\$5,578	360L-BE/33A-WDA
[33/35]50A-WDC	T	.	F	[]	[]	[]		\$5,019	\$4,698	\$4,927	\$5,128	\$5,013	\$5,478	\$5,893	\$5,692	360T/33A-WDA
[33/35]50A-WDC	T-BE	.	F	[]	[]	[]		\$4,962	\$4,641	\$4,870	\$5,071	\$4,956	\$5,421	\$5,836	\$5,635	360T-BE/33A-WDA

For Devices Less Cable System (LCS) Deduct **-\$2,003.00**

- ⓘ Consult factory for lead time
- 🔗 386NL Series trim is handed and not field reversible. Please specify handing, RHR or LHR.
- ¹ Devices in 710 finish are furnished with 695 trims by default
- ² 619 finish available only on 35A Series
- ³ 613 finish has 710 finish device with 613 parts
- ⁴ Wood Doors - 33A-WDA cover plate is required for the 360 series control and will be supplied at an additional, \$75.00 list add.

DEFAULT ATTRIBUTES

Pricing includes default options shown below. Additional options and configurations available.

Cylinders:	Sex bolts	Door thickness	Scalp plate
Not included	Included	1-3/4"	Included

Strike(s):

- Exit hardware:
- Includes 150 and 450 strikes
- Fire exit hardware:
- Includes 150 and 450 strikes

Door opening height - must be specified when placing an order.
 Other heights over 10' are available, consult factory for lead time.
 Non-standard center lines or threshold installed - consult customer support.

OPTIONS

605	606	611	612	613	619	622	625	626	626AM	628	629
US3	US4	US9	US10	US10B	US15	US19	US26	US26D	US26DAM	US28	US32
630	630AM	643e	689	691	693	695	706	710	711	721	728
US32D	US32DAM	-	SP28	SP10	SPBLK	SP313	SP4	313	315	US3A	US4A

LESS BOTTOM ROD (LBR/LBL Fire-Rated Devices must be ordered in pairs, and one Auxiliary Fire Pin (AFL) is furnished per pair.)	Specify (Suffix)	Price adjustment
33/3527LBR	LBR	-\$164.00
33/3527-F-LBR (First Leaf)	LBR	\$0.00
33/3527-F-LBR-AFL (Second Leaf)	LBR-ALF	\$0.00
33/3547LBR	LBR	-\$179.00
33/3547-F-LBR (First Leaf)	LBR	\$0.00
33/3547-F-LBR-AFL (Second Leaf)	LBR-ALF	\$0.00

LESS BOTTOM LATCH (LBR/LBL Fire-Rated Devices must be ordered in pairs, and one Auxiliary Fire Pin (AFL) is furnished per pair.)	Specify (Suffix)	Price adjustment
33/3549LBL	LBL	-\$178.00
33/3549-F-LBL (First Leaf)	LBL	-\$178.00
33/3549-F-LBL-AFL (Second Leaf)	LBL-AFL	\$38.00
33/3550WDC-LBL	LBL	-\$177.00
33/3550WDC-F-LBL (First Leaf)	LBL	-\$177.00
33/3550WDC-F-LBL-AFL (Second Leaf)	LBL-AFL	\$40.00

ANTIMICROBIAL COATING - Available in 626 (US26D) and 630 (US32D), use suffix "AM" when ordering. Example: 626AM	Specify (Suffix)	Price adjustment
For device with or without trim	AM	\$97.00
For trim only	AM	\$45.00

CYLINDER DOGGING - Not for use with fire exit hardware	Specify (Prefix)	Price adjustment
Standard baseplate cylinder dogging	CD	\$138.00
Less dogging	LD	\$0.00
Cylinder dogging with indicator	CDSI	\$458.00
Hex dogging with indicator	HDSI	\$329.00

VON DUPRIN REMOTE UNDOGGING AND REMOTE MONITORING KIT	Consult your access control software provider for pricing and specific scope of support.
<ul style="list-style-type: none"> Modular retrofit kit for 98/99 and 33A/35A Series devices Access control managed via an IP or RS1/ RS-485 connection to the gateway through Allegion software alliance members ENGAGE enabled undogging available. See RU/RM data sheet. For details regarding the configurations that are available, please see Electrical Kits within the Von Duprin catalog. 	

SWITCHES - Available on all 33A/35A Series devices	Specify (Prefix)	Price adjustment
Request to Exit	RX	\$365.00
Waterproof Request to Exit	WP-RX	\$529.00
Request to Exit Low Current	RX-LC	\$424.00
Request to Exit Double Switch	RX-2	\$455.00
RX to RX-2 Conversion (order part number 050271)	RX-AUX	\$380.00

OPTIONS

605	606	611	612	613	619	622	625	626	626AM	628	629
US3	US4	US9	US10	US10B	US15	US19	US26	US26D	US26DAM	US28	US32
630	630AM	643e	689	691	693	695	706	710	711	721	728
US32D	US32DAM	-	SP28	SP10	SPBLK	SP313	SP4	313	315	US3A	US4A

SWITCHES - Available on all 33A/35A Series devices	Specify (Prefix)	Price adjustment
Latch Bolt Monitoring	LX ¹	\$365.00
Latch Bolt Monitoring Low Current	LX-LC ¹	\$424.00
Request to Exit / Latch Bolt Monitoring combination	LX-RX ¹	\$552.00
Request to Exit / Latch Bolt Monitoring combination Low Current	LX-RX-LC ¹	\$665.00
Signal Switch - for Rim and Vertical Rod Devices	SS ²	\$749.00

¹ For 33/3549A and 33/3550A-WDC, LX switch monitors trim input or electric dogging of EL/QEL devices. LX switch does not monitor latch condition.

² Signal Switch option includes RSS lettering on push pad and mortise cylinder for alarm bypass

See page 179-180 for field-installed switch kit part numbers.

LATCH RETRACTION - See 33A/35A product catalog for required accessory equipment	Specify (Prefix)	Price adjustment
Electric latch retraction	EL	\$1,337.00
Quiet electric latch retraction	QEL	\$1,258.00
Quiet electric latch retraction with hex dogging (panic only)	HD-QEL	\$1,258.00
Quiet electric latch retraction for AX devices	QELX	\$1,338.00
Quiet electric latch retraction with hex dogging (panic only) for AX devices	HD-QELX	\$1,338.00
Quiet electric latch retraction (latch bolt only, includes RX switch)	QEL-L	\$2,217.00
Pneumatic	PN	\$2,042.00

EMERGENCY SECURE LOCKDOWN	Specify (Prefix)	Price adjustment
<ul style="list-style-type: none"> No WS; no mechanical dogging of QEL (SD-QEL, HD-QEL) Unit requires a standard 1 1/4" (32mm) mortise cylinder with an inverted straight cam and compression ring and spring. Kit does not come with cylinder or thumbturn, must be ordered separately. Examples: Schlage conventional cylinder: 20-001 1 1/4" XQ11-949; Schlage thumbturn cylinder: 09-904 1 1/4" B502-191 XQ11-949; Schlage ADA thumbturn cylinder: 09-904 1 1/4" XB11-720 B502-191 XQ11-949 Install in alignment with 2018 IBC 1010.2.8 NFPA 101 14.2.2.2.4 or per local AHJ - Only allowed with trim functions: NL, K-NL, L-NL, NL-OP, T-NL 	ESL	\$586.00

QUIET MECHANICAL	Specify (Prefix)	Price adjustment
Controls motion to reduce operational noise. The QM device option provides damper-controlled re-latching. Available on 33A/35A rim and 33/3527A devices. Compatible with most of the device options including QEL, EL, AX, RX, and CD. Not available with CX and LX.	QM	\$266.00

CHEXIT - Available on all 33A/35A Series devices	Specify (Prefix)			Price adjustment
	Prefix	Finish	Release delay	
Chexit – Controlled exit device (15 second delay furnished standard) <ul style="list-style-type: none"> Only available with EO, DT, L-DT, E360LBE, E360TBE functions DT Function requires an electric strike to access opening Chexit is not available with any electrical options (EL, QEL, PN) Chexit is not available with any switches (RX, RXLC, RX2, WP-RX, LX, LXLC, LXR, LXRXC) For CX33/3527A panic and fire devices, two Rod Guards (RGO) supplied standard. Add \$830.00 list per device. For doors over 7' additional RGO's will be added as needed to protect the rods. For each additional RGO, add \$415.00 list For latch protection, latch guards (LGO) found on page 166 can be ordered separately 	CXA	-	.[Release delay]	\$2,667.00
Remote Chexit module	RCM	.[Finish]	.[Release delay]	\$382.00
Chexit 10' cable	CXCAB	-	-	\$171.00

OPTIONS

605	606	611	612	613	619	622	625	626	626AM	628	629
US3	US4	US9	US10	US10B	US15	US19	US26	US26D	US26DAM	US28	US32
630	630AM	643e	689	691	693	695	706	710	711	721	728
US32D	US32DAM	-	SP28	SP10	SPBLK	SP313	SP4	313	315	US3A	US4A

RELEASE DELAY	Specify	Price adjustment
0 Second Delay	0 Delay	\$194.00
30 Second Delay ¹	30 Delay ¹	\$194.00
15 second delay with BOCA Modification	BOCA-15 Delay [ⓧ]	\$194.00
30 second delay with BOCA Modification ¹	BOCA-30 Delay ¹ [ⓧ]	\$194.00
2-60 Seconds in 2 Second Intervals or infinite delay ¹	Other Delays ¹ [ⓧ]	\$263.00

15 second Module sold separately, specify part number 040086.

¹ Over 15 second delay requires a letter of approval from the authority having local jurisdiction over the premises prior to the installation of the device. Allegion cannot grant such approval nor does it warrant local jurisdiction compliance.

[ⓧ] Consult factory for lead time.

EXIT ALARM	Specify	Price adjustment
Exit alarm <ul style="list-style-type: none"> Available on 33A, 35A Series panic and fire devices Price includes RX switch; can substitute with LX switch at no additional charge For vertical rod tampering monitoring on Surface Vertical Devices, specify device with LX (Latch Bolt Monitor Switch) To order Less switch, deduct \$365.00 list 9 volt battery included 	ALK	\$907.00

PULLMAN LATCHES - Not for use with fire exit hardware	Specify	Price adjustment
33A/3527A device PL top and PL bottom	PL	\$370.00
33A/3547A device PL top and PL bottom	PL	\$516.00
33A/3527A device LBR with PL top latch for electric strike application (a panic LBR device is one-point latching not two point, the security of the opening may be compromised)	ES	\$185.00
33A/3547A device LBR with PL top latch for electric strike application (a panic LBR device is one-point latching not two point, the security of the opening may be compromised)	ES	\$258.00

ELECTRIC UNLOCKING	Specify (Prefix)	Price adjustment
<ul style="list-style-type: none"> Electric unlocking of outside lever or thumbturn controls (-BE trims only) 24VDC furnished standard. 12VDC available, consult factory for lead time. Specify Fail Secure (FSE) or Fail Safe (FS). Prefix lever or thumbturn control with "E" Example: E360L-BE, E360T-BE E374TL-BE and E376TL-BE available, consult factory for lead time. 	E	\$909.00

STORM RATING

HURRICANE DEVICE - USE WITH APPROVED ALLEGION DOOR APPLICATIONS

Specify HH (Wind and Impact) or HW (Wind-Only) prefix when ordering devices or mullions for hurricane applications. If application is unknown, specify HH which will satisfy the requirements for both applications. HH option only available for select series and models. HH/HW devices will be furnished with strikes shown in charts (and with through bolts if HH product) and are price-adjusted as indicated. Mullions priced separately.

HH (WIND AND IMPACT)

Model	Door mode	Mullion	Standard strike	Specify (Prefix)	Price adjustment
HH3347A/3547A*	SGL or PR	-	Top: 338 Bottom: 304L	-	-\$97.00
3347A-F/3547A-F	PR	-	Top: 338 Bottom: 304L	HH	-\$97.00
3349A/3549A	SGL or PR	-	Top: 249 Bottom: 349	HH	\$0.00
3349A-F/3549A-F	PR	-	Top: 249 Bottom: 349	HH	\$0.00

*HH33/3547A is furnished with double latch brackets and requires template #10057

OPTIONS

605	606	611	612	613	619	622	625	626	626AM	628	629
US3	US4	US9	US10	US10B	US15	US19	US26	US26D	US26DAM	US28	US32
630	630AM	643e	689	691	693	695	706	710	711	721	728
US32D	US32DAM	-	SP28	SP10	SPBLK	SP313	SP4	313	315	US3A	US4A

HW (WIND ONLY)						
Model	Door mode	Mullion	Standard strike		Specify (Prefix)	Price adjustment
33A/35A Rim	SGL	-	299		HW	-\$122.00
33A/35A Rim	PR	4954 or KR4954	299		HW	-\$122.00
33A-F/35A-F Rim	SGL	-	299F		HW	\$0.00
33A-F/35A-F Rim	PR	9954 or KR9954	499F		HW	\$150.00
3327A/3527A	SGL or PR	-	Top: 299	Bottom: 304L	HW	-\$157.00
3327A-F/3527A-F	PR	-	Top: 299F	Bottom: 304L	HW	\$0.00
3347A/3547A	SGL or PR	-	Top: 338	Bottom: 304L	HW	-\$97.00
3347A-F/3547A-F	PR	-	Top: 338	Bottom: 304L	HW	-\$97.00
3349A/3549A	SGL or PR	-	Top: 249	Bottom: 349	HW	\$0.00
3349A-F/3549A-F	PR	-	Top: 249	Bottom: 349	HW	\$0.00

ACCESSIBLE DEVICE	Specify (Prefix)	Price adjustment
<ul style="list-style-type: none"> Accessible device compliant with the California Building Code (Section 11B-309.4) requirement for 5 lb. maximum operational force. Available on AX33/35A, AX33/35A-F Rim, AX33/3549A LBL and LBL-AFL Trim functions available EO, DT, NL, L, LBE, LDT, T, and TBE EL and QELX options available Not available with CX 	AX	\$89.00

PUSHBAR OPTIONS	Specify		Price adjustment
	Suffix	Handing	
Vision impaired touchpad, raised letters and braille, 630 finish. Standard reads "Caution Stairwell." Optional up to 20 alpha / numeric characters on single line, consult factory.	BRILLE	.[RHR, LHR]	\$180.00
Brass, bronze and stainless touchbar trims embossed "PUSH". No additional charge when specified with device.	EMB	.[RHR, LHR]	\$0.00
Red silk screened touchbar trims (standard on SS devices). "Emergency Exit Only, Push to Open and Sound Alarm" No additional charge when specified with device.	RSS	.[RHR, LHR]	\$0.00
Knurled touchpad. No additional charge when specified with device.	KN	-	\$0.00
Safety glow feature for 3' device	SG	-	\$652.00
Safety glow feature for 4' device	SG	-	\$678.00
Pushbar Armor - built to absorb impact and provides added support, while protecting the pushbar on hinge side of device.	Prefix	Handing	\$27.00
	PA	-	

WEEP HOLES	Specify	Price adjustment
Drainage (weep) holes in mechanism case. 3' device will have 5 holes - 6" spacing, 4' device will have 7 holes	WH	\$128.00

CONNECTORS	Specify	Price adjustment
Cross-category solution using interconnect components for electrified options. Available with ALK, LX, LXLC, LXX, LXXLC, RX, RXLC, and WPRX switches, CX, EL and QEL	CON	\$0.00

NON-STANDARD DOOR THICKNESS (FOR ALL DEVICE TYPES)	Specify	Price adjustment
Door thickness > 2-1/4" - <= 4-1/4"		
33A/35A with EO (exit only no trim)	.DT[]	\$128.00
33A/35A with DT (386), NL (386) or NL-OP (388)	.DT[]	\$256.00
33A/35A with L, L-BE (360)	.DT[]	\$313.00
33A/35A with L-DT (360)	.DT[]	\$254.00

OPTIONS

605	606	611	612	613	619	622	625	626	626AM	628	629
US3	US4	US9	US10	US10B	US15	US19	US26	US26D	US26DAM	US28	US32
630	630AM	643e	689	691	693	695	706	710	711	721	728
US32D	US32DAM	-	SP28	SP10	SPBLK	SP313	SP4	313	315	US3A	US4A

INSULCLAD OR APPLIED PANEL - Not available for fire door applications	Specify	Price adjustment
1/2" Panel - for 33/3547A devices	INS-2	\$96.00
1/4" Panel - for 33/3547A devices	INS-4	\$96.00
1/2" Panel - for 33/3549A devices	INS-2	\$96.00
1/4" Panel - for 33/3549A devices	INS-4	\$96.00

KITS

QUIET MECHANICAL RETROFIT KITS	Specify	Price each
QM Rim Device Retrofit Kit - 33A/35A Rim	47259560	\$266.00
QM SVR Device Retrofit Kit - 33/3527A	47263418	\$266.00

EL CONVERSION KITS - Field conversion kits for Electric Latch Retraction	Specify				Price each
	Standard		Allegion Connect -CON		
	3' device	4' device	3' device	4' device	
EL baseplate conversion kit	050070	050078	050853	050854	\$1,555.00

QEL CONVERSION KITS - Field conversion kits for Quiet Electric Latch Retraction	Specify				Price each
	Standard		Allegion Connect -CON		
	3' device	4' device	3' device	4' device	
Baseplate conversion kits (may be used for ANY conversion application)					
QEL baseplate conversion kit	958003	040065	040063	040066	\$1,323.00
HD-QEL baseplate conversion kit (hex dogging included, panic only)	958004	040067	040064	040068	\$1,323.00
QELX baseplate conversion kit for AX devices	041166	041167	041168	041169	\$1,402.00
HD-QELX Baseplate Conversion Kit for AX devices (hex dogging included, panic only)	041170	041171	041172	041173	\$1,402.00
Modular conversion kits (for non-EL panic devices, for non-EL fire-rated devices sold after October 2014, or for replacing existing motor)					
	Standard		Allegion Connect -CON		Price each
	3' device	4' device	3' device	4' device	
QEL modular conversion kit	114317	114317	040061	040061	\$1,258.00
HD-QEL modular conversion kit (hex dogging included, panic only)	958002	958002	040062	040062	\$1,258.00
QELX modular conversion kit for AX devices	041162	041162	041163	041163	\$1,338.00
HD-QELX modular conversion kit for AX devices (hex dogging Included, panic only)	041164	041164	041165	041165	\$1,338.00
QEL-L modular latch retraction (latchbolt only, includes RX switch)	47895915	47895918	47897871	47897873	\$2,217.00

QEL BUZZER	Specify	Price each
QEL-B modular buzzer kit	47856044	\$357.00

KITS

605	606	611	612	613	619	622	625	626	626AM	628	629
US3	US4	US9	US10	US10B	US15	US19	US26	US26D	US26DAM	US28	US32
630	630AM	643e	689	691	693	695	706	710	711	721	728
US32D	US32DAM	-	SP28	SP10	SPBLK	SP313	SP4	313	315	US3A	US4A

ESL (EMERGENCY SECURE LOCKDOWN) KITS	Specify			Price each
	3' device	4' device	Finish	
33A ESL Kit - Retrofit kit for QEL 33A devices; Panic or Fire (not available in 619 or 630)	967240	967241	.[Finish]	\$586.00
35A ESL Kit - Retrofit kit for QEL 35A, devices; Panic or Fire	967242	967243	.[Finish]	\$586.00

- No WS
- No mechanical dogging of QEL (SD-QEL, HD-QEL)
- Unit requires a standard 1 1/4" (32mm) mortise cylinder with an inverted straight cam and compression ring and spring. Kit does not come with cylinder or thumbturn, must be ordered separately. Examples: Schlage conventional cylinder: 20-001 1 1/4" XQ11-949; Schlage thumbturn cylinder: 09-904 1 1/4" B502-191 XQ11-949; Schlage ADA thumbturn cylinder: 09-904 1 1/4" XB11-720 B502-191 XQ11-949
- Install in alignment with 2018 IBC 1010.2.8 NFPA 101 14.2.2.2.4 or per local AHJ - Only allowed with trim functions: NL, K-NL, L-NL, NL-OP, T-NL

VON DUPRIN REMOTE UNDOGGING AND REMOTE MONITORING KIT <ul style="list-style-type: none"> ▪ Modular retrofit kit for 98/99 and 33A/35A Series rim, SVR, CVR, CVC and 3-point devices ▪ Access control managed via an IP or RS1/ RS-485 connection to the gateway through Allegion software alliance members ▪ ENGAGE enabled undogging available. See RU/RM data sheet. 	Consult your access control software provider for pricing and specific scope of support.
--	--

REMOTE UNDOGGING AND REMOTE MONITORING	Specify		Price each
	Part number	Finish	
Remote Undogging (RU) 3' kit	47258681	.[Finish]	\$1,397.00
Remote Undogging (RU) 4' kit	47258682	.[Finish]	\$1,397.00
Remote Monitoring (RM) 3' kit	47258683	.[Finish]	\$1,067.00
Remote Monitoring (RM) 4' kit	47258684	.[Finish]	\$1,067.00

- ENGAGE gateway sold separately.
- Specify CON for Allegion Connect
- RU option:
 - Enables both remote undogging and door status monitoring (DPS, RX and LX)
 - Not compatible with exit devices with the following options: QEL, DI/CDSI/HDSI, RX2, Schlage AD/CO Trim, SD, SS, PN, E-Strikes/Pullman Latch, CX
 - Compatible device lengths: All 33A/35A and 98/99 device types – 3' (914 mm) length to 2' 9" (838 mm), 4' (1219 mm) length to 3' 3" (991 mm)
- RM option:
 - Enables door status monitoring (DPS, RX and LX) only
 - Not compatible with exit devices with the following options: DI/CDSI/HDSI, RX2, Schlage AD/CO Trim, SD, SS, PN, E-Strikes/Pullman Latch, CX
 - If the door and exit device are fire rated, and the exit device type is a 98/99-F Rim manufactured prior to April 1, 2018, a new center case will be required before proceeding with the installation of the RM kit. 98/99-F Rim Center Case Kit Less Cover, part number 050026.

CX OPTIONS	Specify		Price each
	Part number	Finish	
RCM KIT-33A Less Module	040198	.[Finish]	\$381.00
RCM KIT-35A Less Module	040199	.[Finish]	\$381.00

LBR/LBL RETROFIT KITS FOR FIRE-RATED DEVICES	Specify	Price each
33/3527-F LBR Kit - Auxiliary fire pin and two required 499F Strikes	050171-32	\$657.00
33/3547-F/47WDC-F/49-F LBR/LBL Kit - Auxiliary fire pin only	051860-32	\$216.00
33/3550WDC-F LBL Kit - Auxiliary fire pin, auxiliary fire latch strike, sleeve, and screws	48968887	\$233.00

KITS

605	606	611	612	613	619	622	625	626	626AM	628	629
US3	US4	US9	US10	US10B	US15	US19	US26	US26D	US26DAM	US28	US32
630	630AM	643e	689	691	693	695	706	710	711	721	728
US32D	US32DAM	-	SP28	SP10	SPBLK	SP313	SP4	313	315	US3A	US4A

49 CABLE SYSTEM Device type and door opening height must be specified when ordering	Specify			Price each
	Device type	Part number	Door height Specify height between 6'0" - 10'0"	
Complete cable system Includes: Top and bottom strikes, latches, centerslides, cables and mounting packs	[]	CS	[]	\$1,385.00
Cable system, less bottom latch Includes: Top strike, top latch, top cable, centerslides and mounting packs	[]	CS-LBL	[]	\$1,207.00
Cable system, less bottom latch with fire pin kit Includes: Top strike, top latch, top cable, centerslides, mounting packs and fire pin kit	[]	CS-LBL-49AFL	[]	\$1,424.00

For door opening heights less than 6'10" and more than 10', consult factory.
Consult customer support for non-standard center lines or if a threshold is installed.

50 WDC CABLE SYSTEM Device type and door opening height must be specified when ordering	Specify			Price each
	Device type	Part number	Door height Specify height between 6'0" - 10'0"	
Complete cable system Includes: Top and bottom latches, strikes, cables, centerslide and mounting packs	[]	CS	[]	\$1,586.00
Fire-rated complete cable system Includes: Top and bottom latches, strikes, cables, centerslide, mounting packs, fire kit	[]	CS-F	[]	\$2,003.00
Cable system - Less bottom latch Includes: Top latch, strike, cable, centerslide and mounting packs	[]	CS-LBL	[]	\$1,407.00
Fire-rated cable system - Less bottom latch Includes: Top latch, strike, cable, centerslide, mounting packs, fire kit, fire pin kit	[]	CS-LBL-F	[]	\$2,003.00

INSULCLAD OR APPLIED PANEL KITS - Not available for fire door applications	Specify	Price each
1/2" Panel Kit - for 33/3547A devices	050399	\$96.00
1/4" Panel Kit - for 33/3547A devices	050398	\$96.00
1/2" Panel Kit - for 33/3549A devices	24122277	\$96.00
1/4" Panel Kit - for 33/3549A devices	24122293	\$96.00

PARTS AND ACCESSORIES

605	606	611	612	613	619	622	625	626	626AM	628	629
US3	US4	US9	US10	US10B	US15	US19	US26	US26D	US26DAM	US28	US32
630	630AM	643e	689	691	693	695	706	710	711	721	728
US32D	US32DAM	-	SP28	SP10	SPBLK	SP313	SP4	313	315	US3A	US4A

CENTER CASE										
Description	Specify		Non-finished	628	626	710	612	606	605	
	Part number	Finish							619 ¹	625
33A/35A Rim Center Case Kit L/Cover	050403	-	\$482.00	-	-	-	-	-	-	-
33/3527A Center Case Kit L/Cover	050404	-	\$482.00	-	-	-	-	-	-	-
33/3547A Center Case Kit L/Cover	050405	-	\$482.00	-	-	-	-	-	-	-
33A/35A-F Rim Center Case Kit L/Cover	117000	-	\$646.00	-	-	-	-	-	-	-
33A/35A Rim Center Case Cover Kit	050483	.[Finish]	-	\$78.00	\$137.00	\$98.00	\$90.00	\$90.00	\$180.00	\$180.00
33/3527A Center Case Cover Kit	050484	.[Finish]	-	\$78.00	\$137.00	\$98.00	\$90.00	\$90.00	\$180.00	\$180.00
33/3547A/49A Center Case Cover Kit	050485	.[Finish]	-	\$78.00	\$137.00	\$98.00	\$90.00	\$90.00	\$180.00	\$180.00
33/35A Center Case Cover Screws	900892	.[Finish]	-	\$19.00	\$19.00	\$19.00	\$19.00	\$19.00	\$19.00	\$19.00
Control Link Pin Kit	050529	-	\$19.00	-	-	-	-	-	-	-
Retaining Ring Pkg/10	090107	-	\$19.00	-	-	-	-	-	-	-
Control Link Pin Pkg/10	090031	-	\$24.00	-	-	-	-	-	-	-
33A/35A Device Mtg Package - 1-3/4" - 2-1/4" Dr	900619	-	\$19.00	-	-	-	-	-	-	-
33/3547A Wood Door Mtg Package	900856	-	\$19.00	-	-	-	-	-	-	-

¹ 619 finish available with Series 35A only.

COVER PLATE / CONVERSION KITS										
Description	Specify		Non-finished	628	626	710	612	606	605	
	Part number	Finish							619 ¹	625
33A Hex Dog Conversion Kit	050114	.[Finish]	-	\$104.00	-	\$104.00	\$104.00	\$104.00	\$104.00	\$104.00
35A Hex Dog Conversion Kit	050117	.[Finish]	-	\$104.00	-	\$104.00	\$104.00	\$104.00	\$104.00	\$104.00
33A CD Conversion Kit	050115	.[Finish]	-	\$138.00	-	\$138.00	\$138.00	\$138.00	\$138.00	\$138.00
35A CD Conversion Kit	050132	.[Finish]	-	\$138.00	-	\$138.00	\$138.00	\$138.00	\$138.00	\$138.00
33A CDSI Kit 3' ¹ / ₄	040070/040071	.[Finish]	-	\$458.00	\$458.00	\$458.00	\$458.00	\$458.00	\$458.00	\$458.00
33A HDSI Kit 3' ¹ / ₄	040072/040073	.[Finish]	-	\$329.00	\$329.00	\$329.00	\$329.00	\$329.00	\$329.00	\$329.00
35A CDSI Kit 3' ¹ / ₄	040074/040075	.[Finish]	-	\$458.00	\$458.00	\$458.00	\$458.00	\$458.00	\$458.00	\$458.00
35A HDSI Kit 3' ¹ / ₄	040076/040077	.[Finish]	-	\$329.00	\$329.00	\$329.00	\$329.00	\$329.00	\$329.00	\$329.00
CDSI/HDSI Configuration Pkg	900416-00	-	\$25.00	-	-	-	-	-	-	-
33A Fire or Less Dogging Cover Plate Kit	050133	.[Finish]	-	\$62.00	-	\$62.00	\$62.00	\$62.00	\$62.00	\$62.00
35A Fire or Less Dogging Cover Plate Kit	050109	.[Finish]	-	\$62.00	-	\$62.00	\$62.00	\$62.00	\$62.00	\$62.00
33A PA-CDSI Cover Plate Kit 3'	47568147	.[Finish]	-	\$129.00	-	\$129.00	\$129.00	\$129.00	\$129.00	\$129.00
33A PA-CDSE Cover Plate Kit 4'	47568148	.[Finish]	-	\$129.00	-	\$129.00	\$129.00	\$129.00	\$129.00	\$129.00
35A PA-CDSI Cover Plate Kit 3'	47568151	.[Finish]	-	\$129.00	-	\$129.00	\$129.00	\$129.00	\$129.00	\$129.00
35A PA-CDSI Cover Plate Kit 4'	47568152	.[Finish]	-	\$129.00	-	\$129.00	\$129.00	\$129.00	\$129.00	\$129.00
33A ALK Cover Plate Kit - If ALK device or ALK option were shipped prior to July 2021, a new ALK kit may be required.	47542460	.[Finish]	-	\$215.00	-	\$215.00	\$215.00	\$215.00	\$215.00	\$215.00
35A ALK Cover Plate Kit - If ALK device or ALK option were shipped prior to July 2021, a new ALK kit may be required.	47542461	.[Finish]	-	\$215.00	-	\$215.00	\$215.00	\$215.00	\$215.00	\$215.00

¹ 619 finish available with Series 35A only.

PARTS AND ACCESSORIES

605	606	611	612	613	619	622	625	626	626AM	628	629
US3	US4	US9	US10	US10B	US15	US19	US26	US26D	US26DAM	US28	US32
630	630AM	643e	689	691	693	695	706	710	711	721	728
US32D	US32DAM	-	SP28	SP10	SPBLK	SP313	SP4	313	315	US3A	US4A

COVER PLATE / CONVERSION KITS

Description	Specify			Non-finished	628	626	710	612	606	605 619' 625 711
	Part number	Finish								
33A Center Case Cover Plate (1.42")	050474	.[Finish]		-	\$42.00	-	\$42.00	\$42.00	\$42.00	\$42.00
35A Center Case Cover Plate (1.42")	050475	.[Finish]		-	\$42.00	-	\$42.00	\$42.00	\$42.00	\$42.00
Cover Plate Anti-Rattle Spring Pkg/10	090036	-		\$19.00	-	-	-	-	-	-
Dogging Shaft Pkg/2	090040	-		\$19.00	-	-	-	-	-	-
CDSI/HDSI Tumbler Spring Pkg of 10	47380992	-		\$24.00	-	-	-	-	-	-

¹ 619 finish available with Series 35A only.

END CAP

Description	Specify			Non-finished	628	626	710	612	606	605 619' 625 711
	Part number	Finish								
33A/35A Impact Resistant End Cap Kit	050014	.[Finish]		-	\$115.00	\$128.00	\$115.00	\$142.00	\$130.00	\$130.00
33A/35A Impact Resistant End Cap Scr Pkg	900597	.[Finish]		-	-	\$19.00	\$19.00	\$24.00	\$19.00	\$19.00
33A/35A Impact Resistant End Cap Bracket	050524	-		\$17.00	-	-	-	-	-	-
33A/35A-F Impact Resistant End Cap Kit	957901	.[Finish]		-	\$109.00	\$124.00	\$109.00	\$137.00	\$126.00	\$126.00

PUSH BAR

Description	Specify				Non-finished	628	626	710	612	606	605 619' 625 711
	Part number	Device type	Size	Finish							
33A/35A Push Bar Retrofit Kit - 3' Dr	PBKIT	[]	[]	.[Finish]	-	\$298.00	\$352.00	\$322.00	\$482.00	\$465.00	\$550.00
33A/35A Push Bar Retrofit Kit - 4' Dr	PBKIT	[]	[]	.[Finish]	-	\$320.00	\$388.00	\$347.00	\$502.00	\$482.00	\$571.00
33A/35A PA Push Bar Retrofit Kit - 3' Dr	PA PBKIT	[]	[]	.[Finish]	-	\$355.00	\$409.00	\$355.00	\$539.00	\$522.00	\$607.00
33A/35A PA Push Bar Retrofit Kit - 4' Dr	PA PBKIT	[]	[]	.[Finish]	-	\$377.00	\$445.00	\$377.00	\$559.00	\$539.00	\$628.00
33A/35A Push Bar Guide Pkg/10	090049	-		.[Finish]	\$20.00	-	-	-	-	-	-

MECHANISM CASE

Description	Specify			Non-finished	628	626	710	612	606	605 619' 625 711
	Part number	Finish								
33A Mechanism Case - 3' Dr	050486	.[Finish]		-	\$208.00	-	\$258.00	\$258.00	\$258.00	\$294.00
33A Mechanism Case - 4' Dr	050487	.[Finish]		-	\$294.00	-	\$339.00	\$339.00	\$339.00	\$384.00
35A Mechanism Case - 3' Dr	050488	.[Finish]		-	\$208.00	-	\$258.00	\$258.00	\$258.00	\$294.00
35A Mechanism Case - 4' Dr	050489	.[Finish]		-	\$294.00	-	\$339.00	\$339.00	\$339.00	\$384.00
CD/SS Cylinder Mtg Kit	107813	.[Finish]		-	-	\$86.00	\$90.00	\$90.00	\$90.00	\$98.00
CD/SS Cylinder Locating Washer Pkg	050490	-		\$24.00	-	-	-	-	-	-
CD/SS Mortise Cylinder Collar Pkg	050525	.[Finish]		-	-	\$62.00	\$62.00	\$78.00	\$62.00	\$78.00
CD/SS Cylinder Lock Nut Pkg	050526	-		\$20.00	-	-	-	-	-	-
CD Actuator Pkg/2	090045	-		\$19.00	-	-	-	-	-	-

¹ 619 finish available with Series 35A only.

Items in **bold print** indicate same part number is used for the old 33/35 Series devices.

PARTS AND ACCESSORIES

605	606	611	612	613	619	622	625	626	626AM	628	629
US3	US4	US9	US10	US10B	US15	US19	US26	US26D	US26DAM	US28	US32
630	630AM	643e	689	691	693	695	706	710	711	721	728
US32D	US32DAM	-	SP28	SP10	SPBLK	SP313	SP4	313	315	US3A	US4A

MECHANISM CASE

Description	Specify		Non-finished	628	626	710	612	606	605 619 ¹ 625 711
	Part number	Finish							
CD Dogging Plug Pkg/2 (devices shipped after July 1997)	090046	-	\$18.00	-	-	-	-	-	-
227 Dog Key 5/32" Pkg/2	090005	-	\$30.00	-	-	-	-	-	-
227 Dog Key 5/32" Pkg/10	090085	-	\$101.00	-	-	-	-	-	-
Mechanism Case Brkt Kit	050530	-	\$17.00	-	-	-	-	-	-
Mechanism Case Brkt Screw Pkg/10	090073	-	\$17.00	-	-	-	-	-	-
33A/35A Device Mtg Pkg 1-3/4" - 2-1/4" Door	900619	-	\$19.00	-	-	-	-	-	-
33A/35A Device Mtg Pkg 2-1/4" - 2-3/4"	900380	-	\$44.00	-	-	-	-	-	-
33A/35A Device Mtg Pkg 2-3/4" - 3-1/4"	900429	-	\$127.00	-	-	-	-	-	-
33A/35A Device Mtg Pkg 3-1/4" - 4-1/4"	900430	-	\$127.00	-	-	-	-	-	-
33/3547A Wood Door Mtg Pkg	900856	-	\$19.00	-	-	-	-	-	-

¹ 619 finish available with Series 35A only.

BASEPLATE

Description	Specify		Non-finished	628	626	710	612	606	605 619 ¹ 625 711
	Part number	Finish							
Shock Absorber Pkg	050491	-	\$44.00	-	-	-	-	-	-
Baseplate Screw Pkg/10	090037	-	\$18.00	-	-	-	-	-	-
Baseplate Bumper Pkg/4	090038	-	\$18.00	-	-	-	-	-	-
Baseplate Return Spring Pkg/10	090039	-	\$19.00	-	-	-	-	-	-
Dogging Shaft Pkg/2	090040	-	\$19.00	-	-	-	-	-	-
Dogging Spring Pkg/2	090041	-	\$18.00	-	-	-	-	-	-
Dogging Adapter Spring Pkg/2	090042	-	\$24.00	-	-	-	-	-	-
Dogging Adapter Pkg/2	090043	-	\$19.00	-	-	-	-	-	-
Dogging Hook Pkg/2	090044	-	\$19.00	-	-	-	-	-	-
227 Dog Key 5/32" Pkg/2	090005	-	\$30.00	-	-	-	-	-	-
227 Dog Key 5/32" Pkg/10	090085	-	\$101.00	-	-	-	-	-	-
EL Dogging Rod Kit - 3'	050531	-	\$92.00	-	-	-	-	-	-
EL Dogging Rod Kit - 4'	050532	-	\$92.00	-	-	-	-	-	-
QEL/MEL Motor Cable with 6' Harness	47269206	-	\$84.00	-	-	-	-	-	-
EL Potted Circuit Breaker	050534	-	\$483.00	-	-	-	-	-	-
EL Solenoid/Plunger	050535	-	\$510.00	-	-	-	-	-	-
EL Dogging Rod Retainer	050538	-	\$21.00	-	-	-	-	-	-
EL Receptacle Connector	050539	-	\$20.00	-	-	-	-	-	-
EL Female Terminal	050540	-	\$20.00	-	-	-	-	-	-
SS Cable	050544	-	\$201.00	-	-	-	-	-	-
SS Housing	050545	-	\$670.00	-	-	-	-	-	-
EL Cable Assy	110388	-	\$67.00	-	-	-	-	-	-
CXA FLD Wiring Cable 10'	114905	-	\$163.00	-	-	-	-	-	-

¹ 619 finish available with Series 35A only.

Items in **bold print** indicate same part number is used for the old 33/35 Series devices.

PARTS AND ACCESSORIES

605	606	611	612	613	619	622	625	626	626AM	628	629
US3	US4	US9	US10	US10B	US15	US19	US26	US26D	US26DAM	US28	US32
630	630AM	643e	689	691	693	695	706	710	711	721	728
US32D	US32DAM	-	SP28	SP10	SPBLK	SP313	SP4	313	315	US3A	US4A

VERTICAL LATCHES										
Description	Specify		Non-finished	628	626	710	612	606	605 619 ¹ 625 711	
	Part number	Finish								
33/3527A Top Latch Kit Less Cover	050400	-	\$208.00	-	-	-	-	-	-	
33/3527A Bottom Latch Kit Less Cover	050401	-	\$208.00	-	-	-	-	-	-	
33/3527A Pullman Latch Kit Less Cover	050402	-	\$208.00	-	-	-	-	-	-	
33/3547A Top Latch Kit	050492	-	\$405.00	-	-	-	-	-	-	
33/3547A Bottom Latch Kit	050493	-	\$328.00	-	-	-	-	-	-	
ES33/3547A Top Latch Kit	050128	-	\$294.00	-	-	-	-	-	-	
33/3548A Top Latch Kit-(non EL) <small>For service replacement only. Refer to Retrofit Kits 050047, 050048, 050522 and 050523 to convert 33/3547, 33/3547A Device to 33/3548 or 33A/3548A.</small>	050494	-	\$590.00	-	-	-	-	-	-	
EL33/3548A Top Latch Kit <small>For service replacement only. Refer to Retrofit Kits 050047, 050048, 050522 and 050523 to convert 33/3547, 33/3547A Device to 33/3548 or 33A/3548A.</small>	050516	-	\$574.00	-	-	-	-	-	-	
33/3548A Bottom Latch Kit <small>For service replacement only. Refer to Retrofit Kits 050047, 050048, 050522 and 050523 to convert 33/3547, 33/3547A Device to 33/3548 or 33A/3548A.</small>	050495	-	\$633.00	-	-	-	-	-	-	
33/3548A Latch Retrofit Kit-(non EL)	050047	-	\$987.00	-	-	-	-	-	-	
33/3548A-F Latch Retrofit Kit-(non EL)	050048	-	\$987.00	-	-	-	-	-	-	
EL33/3548A Latch Retrofit Kit	050522	-	\$1,015.00	-	-	-	-	-	-	
EL33/3548A-F Latch Retrofit Kit	050523	-	\$1,015.00	-	-	-	-	-	-	
33/3527A Latch Cover Kit w/Screws	050496	.[Finish]	-	\$109.00	\$186.00	\$126.00	\$109.00	\$109.00	\$188.00	
33/3527A Latch Cover Screw Pkg	900850	.[Finish]	-	\$19.00	\$19.00	\$19.00	\$19.00	\$19.00	\$19.00	
33/3527A Top Latch Compression Spring Pkg/10	090056	-	\$19.00	-	-	-	-	-	-	
33/3527A PL Top Latch Spring Pkg/10	090057	-	\$19.00	-	-	-	-	-	-	
33/3527A Top Latch Aux. Bolt Spring Pkg/10	090076	-	\$19.00	-	-	-	-	-	-	
33/3527A-F AFL Strike Hole Plug	050509	-	\$17.00	-	-	-	-	-	-	
33/3527A Latch Mtg Bracket Kit	050546	-	\$42.00	-	-	-	-	-	-	
33/3527A Latch Screw Pkg	900589	-	\$19.00	-	-	-	-	-	-	
33/3527A-F LBR Latch Mounting Package	900980	-	\$18.00	-	-	-	-	-	-	
LBR Fire Latch/Strike Kit	050171	-	\$657.00	-	-	-	-	-	-	
LBR Strike Plug & Screw Package	900973	-	\$19.00	-	-	-	-	-	-	
33/3547A Latch Mounting Bracket Kit	109324	-	\$80.00	-	-	-	-	-	-	
33/3548A Latch Mounting Bracket Kit	112868	-	\$90.00	-	-	-	-	-	-	
33/3547A Latch Brkt Mtg. Screw (Latch) Pkg/6	090059	-	\$19.00	-	-	-	-	-	-	
33/3547A Latch Brkt Mtg. Screw (Door) Pkg/6	090061	-	\$19.00	-	-	-	-	-	-	
33/3547A/48A Latch Linkage Pin Retaining Ring Pkg/10	090063	-	\$19.00	-	-	-	-	-	-	
33/3547A Latch Link Pin Pkg/10	090064	-	\$19.00	-	-	-	-	-	-	
33/3547A Bolt Return Spring Pkg/10	090065	-	\$19.00	-	-	-	-	-	-	
33/3547A Top Latch Compression Spring Pkg/10	090066	-	\$18.00	-	-	-	-	-	-	
33/3547A Rod Connecting Screw-Latch Pkg/2	090071	-	\$24.00	-	-	-	-	-	-	
33/3548A Rod Connecting Screw-Latch Pkg/2	090072	-	\$24.00	-	-	-	-	-	-	

¹ 619 finish available with Series 35A only.

Items in **bold print** indicate same part number is used for the old 33/35 Series devices.

PARTS AND ACCESSORIES

605	606	611	612	613	619	622	625	626	626AM	628	629
US3	US4	US9	US10	US10B	US15	US19	US26	US26D	US26DAM	US28	US32
630	630AM	643e	689	691	693	695	706	710	711	721	728
US32D	US32DAM	-	SP28	SPIO	SPBLK	SP313	SP4	313	315	US3A	US4A

VERTICAL RODS

Description	Specify		Non-finished	628	626	710	612	606	605
	Part number	Finish							619 ¹
3327A Top Rod Kit	050512	.[Finish]	-	\$112.00	-	\$132.00	\$153.00	\$153.00	\$153.00
3527A Top Rod Kit	050513	.[Finish]	-	\$112.00	\$132.00	\$132.00	\$153.00	\$153.00	\$153.00
3327A Bottom Rod Kit	050514	.[Finish]	-	\$112.00	-	\$132.00	\$153.00	\$153.00	\$153.00
3527A Bottom Rod Kit	050515	.[Finish]	-	\$112.00	-	\$132.00	\$153.00	\$153.00	\$153.00
33/3547A/48A Adj. Top Rod Kit - 6'8"-8'4" Dr	050519	-	\$132.00	-	-	-	-	-	-
33/3547A/48A Bottom Rod Kit	050520	-	\$132.00	-	-	-	-	-	-
3327A One Piece Top Rod Kit - 8'	050650	.[Finish]	-	\$333.00	\$333.00	\$333.00	\$211.00	\$168.00	\$333.00
3327A One Piece Top Rod Kit - 10'	050651	.[Finish]	-	\$367.00	\$367.00	\$367.00	\$233.00	\$203.00	\$360.00
3327A One Piece Top Rod Kit - 12'	050652	.[Finish]	-	\$390.00	\$390.00	\$390.00	\$257.00	\$239.00	\$405.00
3527A One Piece Top Rod Kit - 8'	050653	.[Finish]	-	\$333.00	\$333.00	\$333.00	\$211.00	\$168.00	\$333.00
3527A One Piece Top Rod Kit - 10'	050654	.[Finish]	-	\$367.00	\$367.00	\$367.00	\$233.00	\$203.00	\$360.00
3527A One Piece Top Rod Kit - 12'	050655	.[Finish]	-	\$390.00	\$390.00	\$390.00	\$257.00	\$239.00	\$405.00
3327A Extension Rod 36" Kit	051807	.[Finish]	-	\$42.00	\$42.00	\$42.00	\$42.00	\$42.00	\$42.00
3527A Extension Rod 36" Kit	051811	.[Finish]	-	\$42.00	\$42.00	\$42.00	\$42.00	\$42.00	\$42.00
3327A Extension Rod 60" Kit	050643	.[Finish]	-	\$369.00	-	\$369.00	\$431.00	\$420.00	\$449.00
3527A Extension Rod 60" Kit	050645	.[Finish]	-	\$369.00	-	\$369.00	\$431.00	\$420.00	\$449.00
33/3547A/48A Extension Rod Kit - Adj 8'4"-10'	051808	-	\$42.00	-	-	-	-	-	-
33/3547A/48A Extension Rod Kit - Adj 10'-11'8"	050622	-	\$137.00	-	-	-	-	-	-
33/3547A/48A Extension Rod Kit - Adj 11'8"-13'4"	050623	-	\$153.00	-	-	-	-	-	-
33/3547A/48A Extension Rod Kit - Adj 13'4"-15'	050624	-	\$153.00	-	-	-	-	-	-
33/3527A Rod Guide Pkg	105952	.[Finish]	-	\$115.00	\$173.00	\$122.00	\$122.00	\$122.00	\$173.00
33/3527A Rod Guide Mtg Pkg	900565	-	\$19.00	-	-	-	-	-	-
33/3527A Rod Roll Pin Pkg/10	090054	-	\$20.00	-	-	-	-	-	-
33/3527A Rod Connector-Latch Pkg/2	090067	-	\$30.00	-	-	-	-	-	-
33/3527A Rod Connector-C/Case Pkg/2	090068	-	\$30.00	-	-	-	-	-	-
33/3547A Ratchet Release Pkg	106222	.[Finish]	-	\$196.00	-	\$196.00	\$196.00	\$196.00	\$196.00
33/3547A Ratchet Release Spacer 1/8"	970978	.[Finish]	-	\$31.00	-	\$31.00	\$31.00	\$31.00	-
33/3547A Ratchet Lever Spring Pkg/2	090069	-	\$18.00	-	-	-	-	-	-
33/3547A Ratchet Release Screw Pkg/2	090070	-	\$24.00	-	-	-	-	-	-
33/3547A/-F Rod Connector Extension Bracket	969989	-	\$19.00	-	-	-	-	-	-
33/3547A/-F Rod Connector Screw	972408	-	\$16.00	-	-	-	-	-	-
33/3547A Rod Adjusting Pkg	900620	-	\$31.00	-	-	-	-	-	-
33/3547A 1/4" Insulclad Kit 1-3/4" Dr	050398	-	\$96.00	-	-	-	-	-	-
33/3547A 1/2" Insulclad Kit 1-3/4" Dr	050399	-	\$96.00	-	-	-	-	-	-

¹ 619 finish available with Series 35A only.

PNEUMATIC ACCESSORIES	Specify	Price each
PNT-1 - Pneumatic power transfer	012014-36	\$914.00
PN connector - PN adapter kit - 5/32" to 1/4" LCN tubing	051827-00	\$55.00
PN 5/32" tubing - 25' length	051828-00	\$36.00
PN 5/32" tubing - 50' length	051823-00	\$47.00
PN 5/32" tubing - 100' length	051824-00	\$80.00
PN 5/32" tubing - 200' length	051825-00	\$151.00

Items in **bold print** indicate same part number is used for the old 33/35 Series devices.

PARTS AND ACCESSORIES

605	606	611	612	613	619	622	625	626	626AM	628	629
US3	US4	US9	US10	US10B	US15	US19	US26	US26D	US26DAM	US28	US32
630	630AM	643e	689	691	693	695	706	710	711	721	728
US32D	US32DAM	-	SP28	SP10	SPBLK	SP313	SP4	313	315	US3A	US4A

33A/3549A Series

VERTICAL LATCHES	Specify	Price each
49 Top Latch Assembly	24090110	\$366.00
49 Bottom Latch Assembly	24090128	\$394.00
49 LBL-AFL Fire Pin Kit	051860	\$216.00

CENTERSLIDE KITS	Specify	Price each
33/3549 Centerslide Kit	24090136	\$562.00

49 CABLE		Specify	Price each
For complete 49 Cable System kits, see page 46			
Top Cable Assembly	Door Opening Heights 6'0" to 6'10"	47250398	\$318.00
Top Cable Assembly	Door Opening Heights 6'10" to 8'0"	47250175	\$318.00
Top Cable Assembly	Door Opening Heights >8'0" to 9'2"	47250176	\$318.00
Top Cable Assembly	Door Opening Heights >9'2" to 10'4"	47250177	\$318.00
Bottom Cable Assembly	Door Opening Heights 6'0" to 6'10"	47250403	\$318.00
Bottom Cable Assembly	Door Opening Heights 6'10" to 8'0"	47250178	\$318.00
Bottom Cable Assembly	Door Opening Heights >8'0" to 9'2"	47250179	\$318.00
Bottom Cable Assembly	Door Opening Heights >9'2" to 10'4"	47250180	\$318.00
Replacement Cable Kit (10' core wire, end fitting, and sizing templates)		47250968	\$132.00

For door opening heights more than 10', consult factory. Consult customer support for non-standard center lines or if a threshold is installed.

MOUNTING PACKAGES	Specify	Price each
49 Bottom Mounting Package	23946437	\$100.00
49 Top Mounting Package	23946429	\$70.00
33/3549A HM/AL Centerside Mounting Package	23946460	\$44.00

MISC.	Specify	Price each
Cable Removal Tool - qty 1	24052979	\$22.00
Cable Removal Tool - Pkg/10	24090706	\$168.00
338 Filler Plate	24230914	\$127.00
Spacer Block Kit 3/4" undercut	24231516	\$43.00
Damper Assembly 996	47259557	\$89.00

Items in **bold print** indicate same part number is used for the old 33/35 Series devices.

PARTS AND ACCESSORIES

605	606	611	612	613	619	622	625	626	626AM	628	629
US3	US4	US9	US10	US10B	US15	US19	US26	US26D	US26DAM	US28	US32
630	630AM	643e	689	691	693	695	706	710	711	721	728
US32D	US32DAM	-	SP28	SP10	SPBLK	SP313	SP4	313	315	US3A	US4A

33A/3550AWDC Series

VERTICAL LATCHES	Specify	Price each
Top Latch Kit with mounting pack	48968820	\$515.00
Bottom Latch Kit with mounting pack	48968838	\$430.00

CENTERSLIDE KITS	Specify	Price each
3350A-WDC Centerslide kit with mounting pack	48973309	\$842.00

FIRE KITS	Specify	Price each
33/3550AWDC-F Fire Kit (fire barrier, intumescent for scalp plate and barrier, mounting packs)	48968879	\$438.00

MOUNTING KIT	Specify	Price each
Top, Bottom, and centerslide Mounting Pkg	24685505	\$44.00
Top Latch Mounting Kit	49000409	\$19.00
Bottom Latch Mounting Kit	49000391	\$19.00

CABLES	Specify	Price each
Top Cable 6'8"-7'0" WDC	24648180	\$78.00
Top Cable 7'1"-8'0" WDC	24647273	\$78.00
Top Cable 8'1"-9'0" WDC	24647281	\$88.00
Top Cable 9'1"-10'0" WDC"	24647299	\$88.00
Bottom Cable WDC	24647265	\$78.00

FIRE PIN KIT	Specify	Price each
50WDC Fire pin Kit (current fire pin, fire pin sleeve, fire pin strike)	48968887	\$233.00

LIFT FINGER KIT	Specify	Price each
3350AWDC Lift Finger Kit	24685562	\$130.00

Description	Specify		Non-finished	628	626	710	612	606	605
	Part number	Finish							619 ¹
330/350 Push Bar 1-3/4" Door	900835	-	\$19.00	-	-	-	-	-	625
330/350 Push Bar 2-1/4" Door	900836	-	\$19.00	-	-	-	-	-	711
230/990DT x 330/350 1-3/4" Dr	050140	.[Finish]	-	-	\$24.00	\$24.00	\$24.00	\$24.00	\$24.00
230/990DT x 330/350 2-1/4" Dr	050141	.[Finish]	-	-	\$24.00	\$24.00	\$24.00	\$24.00	\$24.00
696/697DT x 330/350 1-3/4" Dr	050142	.[Finish]	-	-	\$24.00	\$24.00	\$24.00	\$24.00	\$24.00
696/697DT x 330/350 2-1/4" Dr	050143	.[Finish]	-	-	\$24.00	\$24.00	\$24.00	\$24.00	\$24.00

55 SERIES

605	606	611	612	613	619	622	625	626	626AM	628	629
US3	US4	US9	US10	US10B	US15	US19	US26	US26D	US26DAM	US28	US32
630	630AM	643e	689	691	693	695	706	710	711	721	728
US32D	US32DAM	-	SP28	SP10	SPBLK	SP313	SP4	313	315	US3A	US4A

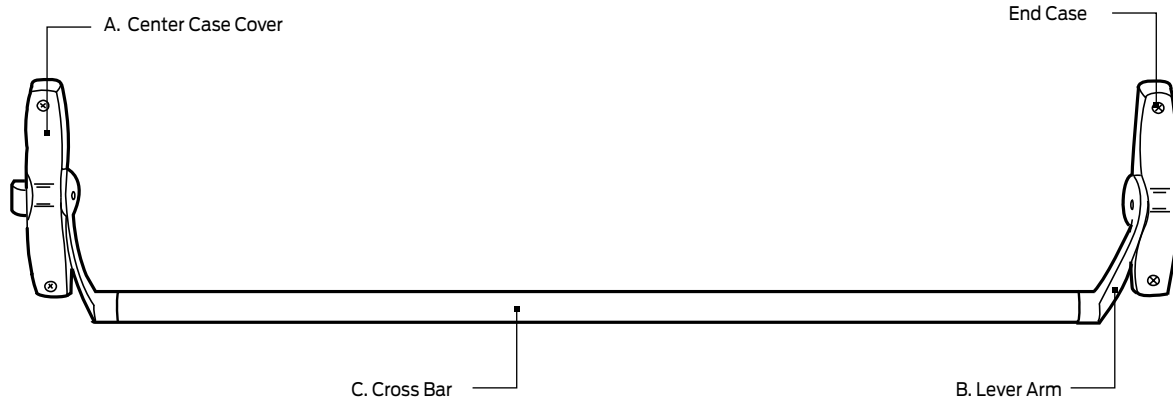

STANDARD FINISHES				
COLOR	US NUMBER	BHMA NUMBER	A, B	C
Bright Brass	US3	605	Buffed Brass, Clear Coat	Buffed Brass, Clear Coat
Satin Brass	US4	606	Satin Brass, Clear Coat	Satin Brass, Clear Coat
Satin Bronze	US10	612	Plated, Clear Coat	Plated, Clear Coat
Satin Bronze, Oil-Rubbed	US10B	613	Oil-Rubbed	Oil-Rubbed
Polished Chrome	US26	625	Plated	Bright Stainless Steel US32, 629
Satin Chrome	US26D	626	Plated	Satin Stainless Steel US32D, 630
Satin Chrome - Antimicrobial	US26D-AM	626-AM	AM Clear over Chrome	AM Clear over Stainless
Aged Bronze	643E	-	Aged Bronze, Relieved	Aged Bronze, no Relief

SPECIAL FINISHES				
COLOR	US NUMBER	BHMA NUMBER	A, B	C
Bright Brass - no Lacquer	US3A	721	Buffed Brass	Bright Brass US3A
Satin Brass - no Lacquer	US4A	728	Satin Brass	Satin Brass US4A
Painted Black	SPBLK	693	Painted	Painted Black, SPBLK

55 SERIES SEX BOLT QUANTITIES	
APPLICATION	625 SEX BOLTS (SUPPLIED)
55 and 5547WDC	4
5547 and 5575	2
5547 EO, DT, NL on Wood Door	4

55 SERIES

605	606	611	612	613	619	622	625	626	626AM	628	629
US3	US4	US9	US10	US10B	US15	US19	US26	US26D	US26DAM	US28	US32
630	630AM	643e	689	691	693	695	706	710	711	721	728
US32D	US32DAM	-	SP28	SP10	SPBLK	SP313	SP4	313	315	US3A	US4A

TYPE OF DEVICE			
55 Rim	5547 Concealed Vertical Rod	5547WDC Wood Door Concealed Vertical Rod	5575 Mortise Lock

FUNCTION			
DT: Dummy Trim	EO: Exit Only	L: Lever-06 Standard	LBE: Lever, Blank Escutcheon
LDT: Lever, Dummy Trim	NL: Night Latch, Key Retracts	NLOP: Night Latch, Opt. Pull	TL: Turn Lever
TLBE: Turn Lever, Blank Escutcheon	TLOP: Turn Lever, Opt. Pull		

RATING	
None: Panic Exit Device	- F: Fire Exit Device

DEVICE FINISH			
605: Bright Brass (US3)	606: Satin Brass (US4)	612: Satin Bronze (US10)	613: Satin Bronze-Oil Rubbed (US10B)
625: Bright Chrome (US26)	626: Satin Chrome (US26D)	693: Painted Black (SPBLK)	

DEVICE HANDING	
RHR: Right Hand Reverse	LHR: Left Hand Reverse

TRIM / CONTROL TRIM			
LC: Less Control	LT: Less Trim	110MD-NL: Night Latch with Cyl-HM	110WD-NL: Night Latch with Cyl-WD
371: Lever Control - 5547	375: Lever Control - 5575	376L: Standard 5547 Lever	376L-BE: Lvr-Blank Escutcheon
376T (Thumbturn Control - 5547	376T WDC: 376T for Wood Door	376WDC-L: 5547 Lever	376WDC-LBE: LBE for Wood Door
379L: Rim - Standard 55 Lever	379L-BE: Lvr-Blank Escutcheon	550DT: Dummy Trim	555NL: Night Latch - HM
555NL-CA: Night Latch with Cyl-HM	556NL: Night Latch - WD	556NL-CA: Night Latch with Cyl-WD	609DT: Dummy Trim
E376L-BE: E-Trim	E376WDC-L-BE: E-Trim	E379L-BE: E-Trim	

CONTROL LEVER STYLES 06 LEVER STANDARD							
Standard levers:	01	02	03	06	07	12	17
Knurled levers:	03K	06K					

TRIM/CONTROL FINISH			
605: Bright Brass (US3)	606: Satin Brass (US4)	611: Bright Bronze - no Lacquer (US9A)	612: Satin Bronze (US10)
616: Satin Bronze -no Lacquer (US10A)	613: Satin Bronze-Oil Rubbed (US10B)	625: Bright Chrome (US26)	626: Satin Chrome (US26D)

MORTISE LOCK		
LL: Less Lock	7500: Standard Mortise	E7500: Electric Unlocking ¹

¹ For E7500, specify FS (Fail Safe) or FSE (Fail Secure). DC standard, specify AC if required. 24VDC standard, specify 12VDC if required.

MORTISE LOCK FINISH			
605: Bright Brass (US3)	606: Satin Brass (US4)	612: Satin Bronze (US10)	613: Satin Bronze-Oil Rubbed (US10B)
630: Satin Stainless (US32D)	693: Painted Black (SPBLK)	622: Matte Black (US19)	629: Bright Stainless Steel (US32)

RODS FOR CONCEALED VERTICAL DEVICES ONLY
LBR: Less Bottom Rod

55 SERIES

605	606	611	612	613	619	622	625	626	626AM	628	629
US3	US4	US9	US10	US10B	US15	US19	US26	US26D	US26DAM	US28	US32
630	630AM	643e	689	691	693	695	706	710	711	721	728
US32D	US32DAM	-	SP28	SP10	SPBLK	SP313	SP4	313	315	US3A	US4A

SWITCH OPTIONS

RX : Request to Exit

ELECTRICAL LOCKING

E: Electric Locking - Mortise, FS or FSE ES: Pullman Latch for Electric Strike

STORM RATING

HW: Wind Only - Hurricane Rated

STRIKE SERIES

LS: Less Strike	LTS: Less Top Strike	1409: Standard 55 Rim	1410: Optional Rim
1609: Optional Rim	1606: Optional Rim	264: Optional Rim or SV	299: Optional Rim
338: Standard CV 5547	471U: Standard CV 5547	472U: Optional 5547WDC 1-3/4	473U: Optional 5547WDC 2-1/4
575: Standard 5575 Mortise	575-2: Optional 5575 Mortise	576A: Optional 5575 1-3/4	576B: Optional 5575 2-1/4

BOTTOM STRIKE SERIES

LBS: Less Bottom Strike	301L: Standard 5547-F	304L: Standard 5547	385A: Optional
-------------------------	-----------------------	---------------------	----------------

STRIKE FINISH

605: Bright Brass (US3)	606: Satin Brass (US4)	612: Satin Bronze (US10)	613: Satin Bronze-Oil Rubbed (US10B)
622: Matte Black (US19)	625: Bright Chrome (US26)	626: Satin Chrome (US26D)	629: Bright Stainless (US32)
630: Satin Stainless (US32D)	691: Satin Bronze (SP10)	695: Duranodic Dark Bronze (313)	MD: e-Moly
611: Bright Bronze - no Lacquer (US9A)	616: Satin Bronze -no Lacquer (US10A)		

CROSS BAR OPTIONS

RCB: Reinforced Crossbar KN: Knurled

CENTERLINE OPTIONS

NY5547: Lever at 45 13/16" NYCA5547: Lever at 44"

MISC DEVICE OPTIONS

10WDA: #10WDA Cover Plate 589: WD Cover Plate CYL: Include Cylinder

SLM BLOCKING

SLM: Include SLM Blocking

DOOR MATERIAL

ALD: Aluminum door CP: Composite door HMD: Hollow metal WD: Wood door

DOOR THICKNESS

DT1-3/4: 1-3/4" Standard DT2: 2" thickness DT2-1/4: 2-1/4" thickness

DOOR/MODE APPLICATION

DE: Pair Double egress doors PR: Pair of doors SGL: Single door

55 SERIES

Rim devices

605	606	611	612	613	619	622	625	626	626AM	628	629
US3	US4	US9	US10	US10B	US15	US19	US26	US26D	US26DAM	US28	US32
630	630AM	643e	689	691	693	695	706	710	711	721	728
US32D	US32DAM	-	SP28	SP10	SPBLK	SP313	SP4	313	315	US3A	US4A

ACN						PRICE BASED ON FINISH						Default trim, included
Device type	Function	Finish	Device size	Handing	Lever design	626	613	612	606 [Ⓜ]	605 [Ⓜ] 625 643E	622 693 [Ⓜ]	
EXIT HARDWARE						3' DEVICE PRICING SHOWN. 4' ADD \$26.00 LIST						
55	. EO	. []	. []			\$3,932	\$3,904	\$3,684	\$3,526	\$4,253	\$4,253	N/A
55	. DT	. []	. []			\$4,724	\$4,696	\$4,485	\$4,152	\$5,067	\$5,067	550DT
55	. NL	. []	. []	. []		\$4,912	\$4,884	\$4,673	\$4,325	\$5,255	\$5,255	550DT/110MD/WD
55	. NL-OP	. []	. []			\$4,120	\$4,092	\$3,872	\$3,699	\$4,441	\$4,441	110MD/WD
55	. L	. []	. []	. []	. []	\$5,195	\$5,153	\$4,947	\$4,638	\$5,622	\$5,502	379L ¹
55	. L-BE	. []	. []	. []	. []	\$5,144	\$5,102	\$4,896	\$4,587	\$5,571	\$5,451	379L-BE ¹

[Ⓜ] Consult factory for lead time.

¹ Wood Doors - #10 WDA cover plate is supplied at an additional, \$75.00 list add.

[Ⓜ] 55 Series devices are handed and field reversible. RHR handing is furnished standard when handing is not specified.

Lever trim is handed and not field reversible, specify handing RHR or LHR.

DEFAULT ATTRIBUTES

Pricing includes default options shown below. Additional options and configurations available.

Cylinders:	Sex bolts	Door thickness	Center line
Not included	Included	1-3/4"	39-13/16"

Strike(s):

Exit hardware:

- Includes 1409 strike

55 SERIES

605	606	611	612	613	619	622	625	626	626AM	628	629
US3	US4	US9	US10	US10B	US15	US19	US26	US26D	US26DAM	US28	US32
630	630AM	643e	689	691	693	695	706	710	711	721	728
US32D	US32DAM	-	SP28	SP10	SPBLK	SP313	SP4	313	315	US3A	US4A

Concealed vertical rod devices (47)

ACN							PRICE BASED ON FINISH					Default trim, included	
Device type	Function	Fire	Finish	Device size	Handing	Lever design	605	625	622				
							626	613	612	606	643E		693
EXIT HARDWARE							3' DEVICE PRICING SHOWN. 4' ADD \$26.00 LIST						
5547	. EO	. []	. []				\$4,835	\$5,126	\$4,735	\$4,598	\$5,371	\$5,371	N/A
5547	. DT	. []	. []				\$5,627	\$5,918	\$5,536	\$5,224	\$6,185	\$6,185	550DT
5547	. NL	. []	. []	. []	. []		\$5,877	\$6,168	\$5,786	\$5,474	\$6,435	\$6,435	555NL ¹
5547	. NL-OP	. []	. []				\$5,350	\$5,641	\$5,250	\$5,032	\$5,886	\$5,886	555CA
5547	. L	. []	. []	. []	. []		\$6,068	\$6,345	\$5,968	\$5,680	\$6,710	\$6,590	376L
5547	. L-BE	. []	. []	. []	. []		\$6,020	\$6,297	\$5,920	\$5,632	\$6,662	\$6,542	376L-BE
5547	. TL	. []	. []				\$6,673	\$6,964	\$6,662	\$6,125	\$7,311	\$7,231	550DT/376T
5547	. TL-BE	. []	. []				\$6,616	\$6,907	\$6,605	\$6,068	\$7,254	\$7,174	550DT/376T-BE
FIRE EXIT HARDWARE²							3' DEVICE PRICING SHOWN. 4' ADD \$26.00 LIST						
5547	. EO	. F	. []	. []			\$5,298	\$5,589	\$5,198	\$5,061	\$5,834	\$5,834	N/A
5547	. DT	. F	. []	. []			\$6,090	\$6,381	\$5,999	\$5,687	\$6,648	\$6,648	550DT
5547	. L	. F	. []	. []	. []		\$6,343	\$6,620	\$6,243	\$5,955	\$6,985	\$6,865	371L
5547	. L-BE	. F	. []	. []	. []		\$6,296	\$6,573	\$6,196	\$5,908	\$6,938	\$6,818	371L-BE
5547	. TL	. F	. []	. []			\$6,883	\$7,174	\$6,863	\$6,377	\$7,556	\$7,419	609DT/376T
5547	. TL-BE	. F	. []	. []			\$6,826	\$7,117	\$6,806	\$6,320	\$7,499	\$7,362	609DT/376-BE

¹ Consult factory for lead time.

¹ 5547L - Minimum control centerline of lever or thumbturn is 49-7/8" and the minimum stile width is 1-3/4". If lower lever mounting height is required, consider NY5547L for 45-13/16" or NYCA5547L for 44" lever mounting height.

² 5547-F - Flush transom installation, specify #900614 Release Bracket, \$173.00 list add per device.

³ 55 Series devices are handed and field reversible. RHR handing is furnished standard when handing is not specified.

Lever trim is handed and not field reversible, specify handing RHR or LHR.

DEFAULT ATTRIBUTES

Pricing includes default options shown below. Additional options and configurations available.

Cylinders:	Sex bolts	Door thickness	Center line
Not included	Included	1-3/4"	39-13/16"

Strike(s):

Exit hardware:

- Includes 471U and 304L strikes

Fire exit hardware:

- Hollow metal doors only
- Includes 301L strike

55 SERIES

605	606	611	612	613	619	622	625	626	626AM	628	629
US3	US4	US9	US10	US10B	US15	US19	US26	US26D	US26DAM	US28	US32
630	630AM	643e	689	691	693	695	706	710	711	721	728
US32D	US32DAM	-	SP28	SP10	SPBLK	SP313	SP4	313	315	US3A	US4A

Wood Door Concealed vertical rod devices (47-WDC)

ACN							PRICE BASED ON FINISH						Default trim, included	
Device type	Function	Fire	Finish	Device size	Handing	Lever design	626	613	612	606 [Ⓜ]	605 [Ⓜ]	625		622
											643E	693 [Ⓜ]		
EXIT HARDWARE							3' DEVICE PRICING SHOWN. 4' ADD \$26.00 LIST							
5547-WDC	. EO	. []	. []				\$5,458	\$5,692	\$4,941	\$4,792	\$5,778	\$5,778	N/A	
5547-WDC	. DT	. []	. []				\$6,250	\$6,484	\$5,742	\$5,418	\$6,592	\$6,592	550DT	
5547-WDC	. NL	. []	. []	. []			\$6,500	\$6,734	\$5,992	\$5,668	\$6,842	\$6,842	556NL [Ⓜ]	
5547-WDC	. NL-OP	. []	. []				\$5,973	\$6,207	\$5,456	\$5,226	\$6,293	\$6,293	556CA	
5547-WDC	. L ¹	. []	. []	. []	. []		\$6,766	\$6,986	\$6,249	\$5,949	\$7,192	\$7,072	376WDC-L/10WDA	
5547-WDC	. L-BE ¹	. []	. []	. []	. []		\$6,718	\$6,938	\$6,201	\$5,901	\$7,144	\$7,024	376WDC-L-BE/10WDA	
5547-WDC	. TL	. []	. []				\$7,371	\$7,605	\$6,943	\$6,394	\$7,793	\$7,713	550DT/376WDC-T/10WDA	
5547-WDC	. TL-BE	. []	. []				\$7,314	\$7,548	\$6,886	\$6,337	\$7,736	\$7,656	550DT/376WDC-T-BE/10WDA	
FIRE EXIT HARDWARE							3' DEVICE PRICING SHOWN. 4' ADD \$26.00 LIST							
5547-WDC	. EO	. F	. []	. []			\$5,698	\$5,932	\$5,181	\$5,032	\$6,018	\$6,018	N/A	
5547-WDC	. DT	. F	. []	. []			\$6,490	\$6,724	\$5,982	\$5,658	\$6,832	\$6,832	550DT	
5547-WDC	. NL	. F	. []	. []	. []		\$6,740	\$6,974	\$6,232	\$5,908	\$7,082	\$7,082	556NL [Ⓜ]	
5547-WDC	. NL-OP	. F	. []	. []			\$6,213	\$6,447	\$5,696	\$5,466	\$6,533	\$6,533	556CA	
5547-WDC	. L ¹	. F	. []	. []	. []	. []	\$7,006	\$7,226	\$6,489	\$6,189	\$7,432	\$7,312	376WDC-L/10WDA	
5547-WDC	. L-BE ¹	. F	. []	. []	. []	. []	\$6,958	\$7,178	\$6,441	\$6,141	\$7,384	\$7,264	376WDC-L-BE/10WDA	
5547-WDC	. TL	. F	. []	. []			\$7,611	\$7,845	\$7,183	\$6,634	\$8,033	\$7,953	550DT/376WDC-T/10WDA	
5547-WDC	. TL-BE	. F	. []	. []			\$7,554	\$7,788	\$7,126	\$6,577	\$7,976	\$7,896	550DT/376WDC-T-BE/10WDA	

[Ⓜ] Consult factory for lead time.

¹ 5547-WDC-L - Minimum centerline 45-13/16".

[Ⓜ] 55 Series devices are handed and field reversible. RHR handing is furnished standard when handing is not specified. Lever trim is handed and not field reversible, specify handing RHR or LHR.

Wood frame applications - specify 472U (1-3/4" Dr.) or 473U (2-1/4" Dr.) top strike.

DEFAULT ATTRIBUTES

Pricing includes default options shown below. Additional options and configurations available.

Cylinders:	Sex bolts	Door thickness	Scalp plate
Not included	Included	1-3/4"	Included

Strike(s):

Exit hardware:
 ▪ Includes 338 and 304L strikes

Fire exit hardware:
 ▪ Includes 338 and 304L strikes

55 SERIES

605	606	611	612	613	619	622	625	626	626AM	628	629
US3	US4	US9	US10	US10B	US15	US19	US26	US26D	US26DAM	US28	US32
630	630AM	643e	689	691	693	695	706	710	711	721	728
US32D	US32DAM	-	SP28	SP10	SPBLK	SP313	SP4	313	315	US3A	US4A

Mortise lock devices (75)

ACN							PRICE BASED ON FINISH						Default trim, included
Device type	Function	Fire	Finish	Device size	Handing	Lever design	626	613	612	606	605	622	
											625	693	
EXIT HARDWARE							3' DEVICE PRICING SHOWN. 4' ADD \$26.00 LIST						
5575	. EO	. []	. []				\$3,731	\$4,352	\$3,528	\$3,410	\$4,321	\$4,321	N/A ¹
5575	. DT	. []	. []				\$4,523	\$5,144	\$4,329	\$4,036	\$5,135	\$5,135	550DT ¹
5575	. NL	. []	. []	. []	. []		\$4,523	\$5,144	\$4,329	\$4,036	\$5,135	\$5,135	550DT ¹
5575	. L	. []	. []	. []	. []		\$4,973	\$5,580	\$4,770	\$4,501	\$5,669	\$5,549	375L ¹
5575	. L-BE	. []	. []	. []	. []		\$4,916	\$5,523	\$4,713	\$4,444	\$5,612	\$5,492	375L-BE ¹
5575	. L-DT	. []	. []	. []	. []		\$4,898	\$5,505	\$4,695	\$4,426	\$5,594	\$5,474	375L-DT ¹
FIRE EXIT HARDWARE²							3' DEVICE PRICING SHOWN. 4' ADD \$26.00 LIST						
5575	. EO	. F	. []	. []			\$4,038	\$4,659	\$3,835	\$3,717	\$4,628	\$4,628	N/A ¹
5575	. DT	. F	. []	. []			\$4,830	\$5,451	\$4,636	\$4,343	\$5,442	\$5,442	550DT ¹
5575	. NL	. F	. []	. []	. []		\$4,830	\$5,451	\$4,636	\$4,343	\$5,442	\$5,442	550DT ¹
5575	. L	. F	. []	. []	. []		\$5,280	\$5,887	\$5,077	\$4,808	\$5,976	\$5,856	375L ¹
5575	. L-BE	. []	. []	. []	. []		\$5,223	\$5,830	\$5,020	\$4,751	\$5,919	\$5,799	375L-BE ¹

ⓘ Consult factory for lead time.

¹ Wood Doors - 589 cover plate is required for 5575 devices on wood doors and will be supplied at an additional price. Refer to page 163 for price by finish.

🔑 55 Series devices are handed and field reversible. RHR handing is furnished standard when handing is not specified.

Lever trim is handed and not field reversible, specify handing RHR or LHR.

Door Thickness 2-1/4" - for wood door is a Special Order Product. Consult factory for lead time.

DEFAULT ATTRIBUTES

Pricing includes default options shown below. Additional options and configurations available.

Cylinders:	Sex bolts	Door thickness	Center line
Not included	Included	1-3/4"	39-13/16"

Strike(s):

Exit hardware:

- Includes 575 strike

Fire exit hardware:

- Includes 575 strike

OPTIONS

605	606	611	612	613	619	622	625	626	626AM	628	629
US3	US4	US9	US10	US10B	US15	US19	US26	US26D	US26DAM	US28	US32
630	630AM	643e	689	691	693	695	706	710	711	721	728
US32D	US32DAM	-	SP28	SP10	SPBLK	SP313	SP4	313	315	US3A	US4A

SWITCHES	Specify (Prefix)	Price adjustment
Request to Exit - Crossbar monitor switch in end case ▪ Factory install only	RX	\$365.00

PULLMAN LATCHES - Not for use with fire exit hardware	Specify	Price adjustment
ES Pullman Top Latch for 5547 Device (Metal doors, LBR only)	ES	\$389.00

ELECTRIC UNLOCKING	Specify (Prefix)	Price adjustment
<ul style="list-style-type: none"> Electric unlocking of outside lever for all 5575 mortise devices Available with 5575 mortise L-BE and L-BE-F lever trim only For 24VAC installation a SO24 Rectifier Kit will be supplied at an additional \$61.00 list add. Specify FAIL SECURE (FSE) or FAIL SAFE (FS). SO rectifier kit intended for fail secure / momentary use only. Contact product support for assistance. 	E	\$909.00
<ul style="list-style-type: none"> Electric unlocking of outside 55 Series lever or thumbturn controls Available with 371L-BE, 376L-BE, 376WDC-L-BE, 379L-BE, 376T-BE, 376WDC-T-BE functions only 24VDC furnished standard Prefix Lever or Thumbturn Control with "E" Example: E371L-BE 		\$909.00

STORM RATING
HURRICANE DEVICE - USE WITH APPROVED ALLEGION DOOR APPLICATIONS
Specify HH (Wind and Impact) or HW (Wind-Only) prefix when ordering devices or mullions for hurricane applications. If application is unknown, specify HH which will satisfy the requirements for both applications. HH option only available for select series and models. HH/HW devices will be furnished with strikes shown in charts (and with through bolts if HH product) and are price-adjusted as indicated. Mullions priced separately.

HW (WIND-ONLY)						
Model	Door mode	Mullion	Standard strike		Specify (Prefix)	Price adjustment
55 Rim	SGL	-	299		HW	-\$122.00
55 Rim ¹	PR	5754	1408		HW	-\$210.00
5547	SGL or PR	-	Top: 471U	Bottom: 304L	HW	\$0.00

¹ Adjustment reflects device ordered "less strike"

CROSSBAR OPTIONS	Specify (Prefix)	Price adjustment
Reinforced Crossbar	RCB	\$150.00
Knurled Crossbar (KN must be ordered as 4' device; cut bar as needed)	KN	\$173.00

CENTERLINE OPTIONS	Specify (Prefix)	Price adjustment
Lever at 45-13/16", device at standard centerline 39-13/16" from finished floor, Up to 10' opening (metal doors)	NY5547 (L, LBE, LDT)	\$0.00
Lever at 44", device at centerline 38" from finished floor, Up to 8' opening (metal doors)	NYCA5547 (L, LBE, LDT)	\$107.00

PARTS AND ACCESSORIES

605	606	611	612	613	619	622	625	626	626AM	628	629
US3	US4	US9	US10	US10B	US15	US19	US26	US26D	US26DAM	US28	US32
630	630AM	643e	689	691	693	695	706	710	711	721	728
US32D	US32DAM	-	SP28	SP10	SPBLK	SP313	SP4	313	315	US3A	US4A

CENTER CASE KITS (INCLUDES MOUNTING SCREWS)

Description	Specify		Non-finished	613, 626	612	606	605, 619, 622, 625, 693
	Part number	Finish					
55EO Center Case Kit	050183	.[Finish]	-	\$1,202.00	\$1,297.00	\$1,202.00	\$1,527.00
55NL Center Case Kit	050184	.[Finish]	-	\$1,288.00	\$1,455.00	\$1,288.00	\$1,612.00
5575 Center Case RHR Kit	050185	.[Finish]	-	\$764.00	\$854.00	\$764.00	\$977.00
5575 Center Case LHR Kit	050186	.[Finish]	-	\$764.00	\$854.00	\$764.00	\$977.00
5575-F Center Case RHR Kit	050187	.[Finish]	-	\$851.00	\$943.00	\$851.00	\$1,065.00
5575-F Center Case LHR Kit	050188	.[Finish]	-	\$851.00	\$943.00	\$851.00	\$1,065.00
5547 RHR Center Case Kit	050189	.[Finish]	-	\$764.00	\$854.00	\$764.00	\$977.00
5547 LHR Center Case Kit	050191	.[Finish]	-	\$764.00	\$854.00	\$764.00	\$977.00
5547-F RHR Center Case Kit	050192	.[Finish]	-	\$851.00	\$943.00	\$851.00	\$1,065.00
5547-F LHR Center Case Kit	050193	.[Finish]	-	\$851.00	\$943.00	\$851.00	\$1,065.00
5547WDC RHR Center Case Kit	050194	.[Finish]	-	\$851.00	\$943.00	\$851.00	\$1,065.00
5547WDC LHR Center Case Kit	050195	.[Finish]	-	\$851.00	\$943.00	\$851.00	\$1,065.00

CENTER CASE PARTS - RIM

Description	Specify		Non-finished	613, 626	612	606	605, 619, 622, 625, 693
	Part number	Finish					
55CK-NL Conversion Kit (Order Trim Separate)	050105	-	\$79.00	-	-	-	-
55 Rim Backplate w/Screws	050332	.[Finish]	-	\$103.00	\$109.00	\$103.00	\$109.00
55 Case Bushing	050333	-	\$24.00	-	-	-	-
55 Rim Spring Clip w/Screws	050334	-	\$33.00	-	-	-	-
55 Rim Latch Bolt w/Axle and Spring	050352	-	\$227.00	-	-	-	-
55 Rim Latch Bolt Axle	050353	-	\$19.00	-	-	-	-
55 Rim Latch Bolt Spring	050354	-	\$19.00	-	-	-	-
55NL CAM RH	050355	-	\$51.00	-	-	-	-
55NL CAM LH	050356	-	\$51.00	-	-	-	-
55 Axle Retainer Pkg/2	090023	-	\$41.00	-	-	-	-
55 Spring Anchor Screw Pkg/10	090024	-	\$17.00	-	-	-	-
55 Backplate Screw Pkg/10	090025	-	\$17.00	-	-	-	-
55 Rim Center Case Retaining Screw Pkg/2	090022	-	\$62.00	-	-	-	-
55 Rim Center Case Retaining Screw Pkg/10	090050	-	\$289.00	-	-	-	-
55 Rim Center Case Mounting Pkg	900507	.[Finish]	-	\$19.00	\$19.00	\$19.00	\$19.00
55 Rim 2" Dr SNB Mounting Pkg	900512	.[Finish]	-	\$19.00	\$19.00	\$19.00	\$19.00

PARTS AND ACCESSORIES

605	606	611	612	613	619	622	625	626	626AM	628	629
US3	US4	US9	US10	US10B	US15	US19	US26	US26D	US26DAM	US28	US32
630	630AM	643e	689	691	693	695	706	710	711	721	728
US32D	US32DAM	-	SP28	SP10	SPBLK	SP313	SP4	313	315	US3A	US4A

CENTER CASE PARTS - 5547

Description	Specify		Non-finished	613, 626	612	606	605, 619, 622, 625, 693
	Part number	Finish					
5547 Control Lever	050357	-	\$73.00	-	-	-	-
55 Retaining Screw Pkg/10	090051	-	\$289.00	-	-	-	-
55 Retaining Screw Pkg/2	090026	-	\$62.00	-	-	-	-
55 Case Bushing	050333	-	\$24.00	-	-	-	-
5547 Center Case Mounting Pkg	900508	.[Finish]	-	\$19.00	\$19.00	\$19.00	\$19.00
5547 2" Dr SNB Mounting Pkg	900514	.[Finish]	-	\$19.00	\$19.00	\$19.00	\$19.00
5547 Blind Fastener Package	900539	-	\$66.00	-	-	-	-

CENTER CASE KITS – 5547–F/5547WDC/5575/5575–F

Description	Specify		Non-finished	613, 626	612	606	605, 619, 622, 625, 693
	Part number	Finish					
5547-F/47WDC/75/75F Lift Member	050360	-	\$153.00	-	-	-	-
5547-F/47WDC Lift Member Channel	050359	-	\$57.00	-	-	-	-
5547/47–F Latch Release Spring	050362	-	\$19.00	-	-	-	-
5547-F/47WDC Spring Anchor	050363	-	\$24.00	-	-	-	-
5547-F/47WDC Lift Member Lever	050358	-	\$76.00	-	-	-	-
55 Case Bushing	050333	-	\$24.00	-	-	-	-
55 Retaining Screw Pkg/10	090051	-	\$289.00	-	-	-	-
55 Retaining Screw Pkg/2	090026	-	\$62.00	-	-	-	-
55 Spring Anchor Screw Pkg/10	090024	-	\$17.00	-	-	-	-
Lift Member Guide Screw Pkg/10	090027	-	\$17.00	-	-	-	-
5547-F/5575/75–F Center Case Mounting Pkg	900509	.[Finish]	-	\$19.00	\$19.00	\$19.00	\$19.00
5547WDC Center Case Mounting Pkg	900507	.[Finish]	-	\$19.00	\$19.00	\$19.00	\$19.00
5547WDC 2" Dr SNB Mounting Pkg	900512	.[Finish]	-	\$19.00	\$19.00	\$19.00	\$19.00
5547/75 2" Dr SNB Mounting Pkg	900514	.[Finish]	-	\$19.00	\$19.00	\$19.00	\$19.00

CROSSBARS

Description	Specify		Non-finished	613, 626	612	606	605, 619, 622, 625, 693
	Part number	Finish					
42" Standard Crossbar Kit	050004	.[Finish]	-	\$322.00	\$332.00	\$322.00	\$340.00
42" Knurled Crossbar Kit	050005	.[Finish]	-	\$521.00	\$530.00	\$521.00	\$562.00
37" Crossbar Reinforcement Kit	050459	-	\$175.00	-	-	-	-

PARTS AND ACCESSORIES

605	606	611	612	613	619	622	625	626	626AM	628	629
US3	US4	US9	US10	US10B	US15	US19	US26	US26D	US26DAM	US28	US32
630	630AM	643e	689	691	693	695	706	710	711	721	728
US32D	US32DAM	-	SP28	SP10	SPBLK	SP313	SP4	313	315	US3A	US4A

END CASE

Description	Specify		Non-finished	613, 626	612	606	605, 619, 622, 625, 693
	Part number	Finish					
55R/5575/5547 RHR End Case Kit	050196	.[Finish]	-	\$518.00	\$562.00	\$518.00	\$730.00
55R/5575/5547 LHR End Case Kit	050197	.[Finish]	-	\$518.00	\$562.00	\$518.00	\$730.00
5547/75-F RHR End Case Kit	050198	.[Finish]	-	\$518.00	\$562.00	\$518.00	\$730.00
5547/75-F LHR End Case Kit	050199	.[Finish]	-	\$518.00	\$562.00	\$518.00	\$730.00
RX5547/75/-F LHR End Case Kit	040000	.[Finish]	-	\$1,002.00	\$1,049.00	\$1,002.00	\$1,227.00
RX5547/75/-F RHR End Case Kit	040001	.[Finish]	-	\$1,002.00	\$1,049.00	\$1,002.00	\$1,227.00
55 Series End Case Backplate	050364	-	\$24.00	-	-	-	-
55 Retaining Screw Pkg/10	090051	-	\$289.00	-	-	-	-
55 Retaining Screw Pkg/2	090026	-	\$62.00	-	-	-	-
55 End Case Spring Pkg/20	090052	-	\$112.00	-	-	-	-
55 End Case Spring Pkg/4	090028	-	\$55.00	-	-	-	-
55 End Case Spring Lever	050366	-	\$62.00	-	-	-	-
55 Series End Case Mounting Pkg	900507	.[Finish]	-	\$19.00	\$19.00	\$19.00	\$19.00

LEVER ARMS

Description	Specify		Non-finished	613, 626	612	606	605, 619, 622, 625, 693
	Part number	Finish					
55 R/M/CV LH Lever Arm Kit	050112	.[Finish]	-	\$552.00	\$590.00	\$482.00	\$632.00
55 R/M/CV RH Lever Arm Kit	050136	.[Finish]	-	\$552.00	\$590.00	\$482.00	\$632.00
5547-F/75-F LH Lever Arm Kit	050137	.[Finish]	-	\$552.00	\$590.00	\$482.00	\$632.00
5547-F/75-F RH Lever Arm Kit	050139	.[Finish]	-	\$552.00	\$590.00	\$482.00	\$632.00

55 CROSSBAR MISC.

Description	Specify		Non-finished	613, 626	612	606	605, 625, 693
	Part number	Finish					
55 Wedgetite Screw Pkg/2	090008	-	\$16.00	-	-	-	-
55 Wedgetite Screw Pkg/30	090081	-	\$76.00	-	-	-	-
Crossbar Tube Attaching Wedge Pkg/2	090020	-	\$19.00	-	-	-	-
Crossbar Tube Attaching Ring Pkg/2	090021	-	\$24.00	-	-	-	-
55 Dog Screw Pkg/2	090029	-	\$33.00	-	-	-	-
55 Dog Screw Pkg/10	090053	-	\$103.00	-	-	-	-
227 Dog Key 5/32" Pkg/2	090005	-	\$30.00	-	-	-	-
227 Dog Key 5/32" Hex Pkg/10	090085	-	\$101.00	-	-	-	-
55 Series Special Hex Key (Reversing Pkg)	103866	-	\$19.00	-	-	-	-

PARTS AND ACCESSORIES

605	606	611	612	613	619	622	625	626	626AM	628	629
US3	US4	US9	US10	US10B	US15	US19	US26	US26D	US26DAM	US28	US32
630	630AM	643e	689	691	693	695	706	710	711	721	728
US32D	US32DAM	-	SP28	SP10	SPBLK	SP313	SP4	313	315	US3A	US4A

VERTICAL LATCHES

Description	Specify		Non-finished	613, 626	612	606	605, 619, 622, 625, 693
	Part number	Finish					
5547-F Soffit Latch Kit	114141	-	\$292.00	-	-	-	-
5547-F Release Guide Cover w/Screws	050278	.[Finish]	-	\$289.00	\$289.00	\$289.00	\$392.00
5547/47WDC Bottom Bracket Guide	050370	-	\$122.00	-	-	-	-
5547 Rod Connector Rivet Pkg/10	090011	-	\$17.00	-	-	-	-
5547WDC Top Plate Screw Pkg/10	090033	-	\$20.00	-	-	-	-
5547-F Plunger Release Brkt Screws Pkg/10	090034	.[Finish]	-	\$31.00	\$31.00	\$31.00	\$31.00
5547-F Flush Tran. Release Screws Pkg/10	090035	.[Finish]	-	\$24.00	\$24.00	\$24.00	\$24.00
5547/47WDC Top Plate	100316	-	\$178.00	-	-	-	-
5547 Soffit Latch Mounting Pkg	900502	-	\$17.00	-	-	-	-
5547-F Plunger Release Bracket	900576	.[Finish]	-	\$118.00	\$118.00	\$118.00	\$118.00
5547-F Flush Transom Release Brkt w/Screws	900614	.[Finish]	-	\$173.00	\$173.00	\$173.00	\$173.00
5547-F Top Latch Release Screws Pkg/20	PKGSRV.1018	-	\$19.00	-	-	-	-

VERTICAL RODS

Description	Specify		Non-finished	613, 626	612	606	605, 619, 622, 625, 693
	Part number	Finish					
5547 Top Rod Kit 6'8"-8' Door	050053	-	\$563.00	-	-	-	-
5547-F Top Rod Kit 6'8"-8' Door	050457	.[Finish]	-	\$563.00	\$563.00	\$563.00	\$563.00
5547WDC Top Rod Kit 6'8"-8' Door	050110	-	\$563.00	-	-	-	-
ES5547 Top Latch/Rod Serv Kit	050656	-	\$641.00	-	-	-	-
5547 Top Rod Kit 8'-10' Door	050372	-	\$598.00	-	-	-	-
5547-F Top Rod Kit 8'-10' Door	050373	.[Finish]	-	\$598.00	\$598.00	\$598.00	\$598.00
5547WDC Top Rod Kit 8'-10' Door	050374	-	\$598.00	-	-	-	-
5547 Bottom Rod Kit	050036	-	\$563.00	-	-	-	-
5547-F Bottom Rod Kit	050458	-	\$563.00	-	-	-	-
5547WDC Bottom Rod Kit	050096	-	\$563.00	-	-	-	-
5547 Extension Rod Kit 8'-10' Door	051704	-	\$42.00	-	-	-	-
5547-F Extension Rod Kit 8'-10' Door	051705	-	\$42.00	-	-	-	-
5547WDC Extension Rod Kit 8'-10' Door	051707	-	\$42.00	-	-	-	-
5547 Extension Rod Kit 10'-12' Door	050631	-	\$136.00	-	-	-	-
5547-F Extension Rod Kit 10'-12' Door	050634	-	\$286.00	-	-	-	-
5547WDC Extension Rod Kit 10'-12' Door	050639	-	\$300.00	-	-	-	-
5547 Extension Rod Kit 12'-14' Door	050632	-	\$136.00	-	-	-	-
5547-F Extension Rod Kit 12'-14' Door	050635	-	\$286.00	-	-	-	-
5547WDC Extension Rod Kit 12'-14' Door	050640	-	\$300.00	-	-	-	-
5547 Extension Rod Kit 14'-16' Door	050633	-	\$136.00	-	-	-	-
5547-F Extension Rod Kit 14'-16' Door	050636	-	\$286.00	-	-	-	-
5547WDC Extension Rod Kit 14'-16' Door	050641	-	\$300.00	-	-	-	-
5547 Rod Control Housing	050367	-	\$512.00	-	-	-	-

PARTS AND ACCESSORIES

605	606	611	612	613	619	622	625	626	626AM	628	629
US3	US4	US9	US10	US10B	US15	US19	US26	US26D	US26DAM	US28	US32
630	630AM	643e	689	691	693	695	706	710	711	721	728
US32D	US32DAM	-	SP28	SP10	SPBLK	SP313	SP4	313	315	US3A	US4A

VERTICAL RODS

Description	Specify		Non-finished	613, 626	612	606	605, 619, 622, 625, 693
	Part number	Finish					
5547 Top Rod Connector w/Pin	050368	-	\$70.00	-	-	-	-
5547 Bottom Rod Connector w/Pin	050369	-	\$62.00	-	-	-	-
5547-F Rod Guide Mounting Screws Pkg/10	090018	-	\$17.00	-	-	-	-
5547 Rod Connector Pin Pkg/2	090030	-	\$20.00	-	-	-	-
5547 Top Rod 1/8 x 5/8 Roll Pin Pkg/10	090032	-	\$17.00	-	-	-	-
5547WDC Latch Control	100315	-	\$545.00	-	-	-	-
5547-F Bottom Guide Package	100741	-	\$122.00	-	-	-	-
5547-F Rod Guide Package	105144	-	\$24.00	-	-	-	-
5547-F Rod Set Mounting Package	900541	-	\$17.00	-	-	-	-

88 SERIES

605	606	611	612	613	619	622	625	626	626AM	628	629
US3	US4	US9	US10	US10B	US15	US19	US26	US26D	US26DAM	US28	US32
630	630AM	643e	689	691	693	695	706	710	711	721	728
US32D	US32DAM	-	SP28	SP10	SPBLK	SP313	SP4	313	315	US3A	US4A

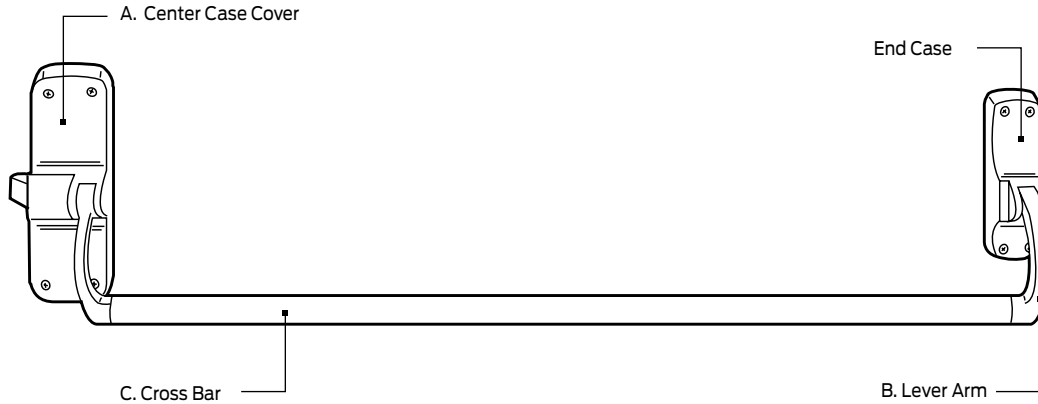

STANDARD FINISHES				
COLOR	US NUMBER	BHMA NUMBER	A, B, D	C - CROSS BAR FINISHES
Bright Brass	US3	605	Buffed Brass, Clear Coat	Buffed Brass, Clear Coat
Satin Brass	US4	606	Satin Brass, Clear Coat	Satin Brass, Clear Coat
Satin Bronze	US10	612	Plated/ Anodized	Satin Bronze US10
Satin Bronze, Oil-Rubbed	US10B	613	Oil-Rubbed	Oil Rubbed, US10B, 613
Polished Chrome	US26	625	Plated	Bright Stainless Steel US32, 629
Satin Chrome	US26D	626	Plated	Satin Stainless Steel US32D, 630
Black	SPBLK	693	Powder Coat	Powder Coat, SPBLK, 693
Aged Bronze	643E	-	Aged Bronze, Relieved	Aged Bronze, no Relief

SPECIAL FINISHES				
COLOR	US NUMBER	BHMA NUMBER	A, B, D	C - TOUCH BAR TRIM FINISHES
Bright Brass- no Lacquer	US3A	721	Buffed Brass	Bright Brass US3A
Satin Brass- no Lacquer	US4A	728	Satin Brass	Satin Brass US4A
Satin Chrome - Antimicrobial	US26D-AM	626-AM	AM Clear over Plated	AM - Clear over Satin Stainless Steel

Note: On a fire device "A" = Stainless Steel Substrate

88 SERIES SEX BOLT QUANTITIES		
APPLICATION	425 SEX BOLTS (OPTIONAL)	FOR COMPOSITE OR WOOD FIRE DOORS 425 SEX BOLTS(SUPPLIED)
88 or 8875 with Trim	4	4
88 or 8875 EO (exit device only)	8	8
8827 with trim	12	12
8827 EO (exit device only)	16	16
8847	4	4

88 SERIES

605	606	611	612	613	619	622	625	626	626AM	628	629
US3	US4	US9	US10	US10B	US15	US19	US26	US26D	US26DAM	US28	US32
630	630AM	643e	689	691	693	695	706	710	711	721	728
US32D	US32DAM	-	SP28	SP10	SPBLK	SP313	SP4	313	315	US3A	US4A

TYPE OF DEVICE			
88 Rim	8827 Surface Vertical Rod	8847 Concealed Vertical Rod	8875 Mortise Lock

FUNCTION			
DT: Dummy Trim	EO: Exit Only	K: Knob	KBE: Knob Blank Escutcheon
KDT: Knob Dummy	KNL: Knob Night Latch	L: Lever-06 Standard	LDT: Lever, Dummy Trim
LBE: Lever, Blank Escutcheon	NL: Night Latch, Key Retracts	NLOP: Night Latch, Opt. Pull	TL: Turn Lever
TLBE: Turn Lever, Blank Escutcheon	TLOP: Turn Lever, Opt. Pull	TP: Thumbpiece	TPBE: Thumbpiece - Blank Escutcheon
TPNL: Thumbpiece - Night Latch			

RATING	
None: Panic Exit Device	- F: Fire Exit Device

DEVICE FINISH			
605: Bright Brass (US3)	721: Bright Brass - No Lacquer (US3A)	606: Satin Brass (US4)	728: Satin Brass - No Lacquer (US4A)
612: Satin Bronze (US10)	613: Satin Bronze-Oil Rubbed (US10B)	625: Bright Chrome (US26)	626: Satin Chrome (US26D)
711: Black (315)			

DEVICE HANDING	
RHR: Right Hand Reverse	LHR: Left Hand Reverse

TRIM / CONTROL TRIM			
LC: Less Control	LT: Less Trim	110MD / 110WD: Standard on NL-OP	216D: Cylinder Anchor
371: Lever - 8847-F	373: Lever - 88 Rim, 8827 / 8875	376T: Thumbturn Control -CV	377T: Thumbturn - 8827
606/608: Optional Trim	880: Standard Trim	880SA: Standard Vertical Surface Applied	880WDF: Standard 88-F Rim wood / composite door

CONTROL LEVER STYLES 06 LEVER STANDARD											
Standard levers:	01	02	03	06	07	12	17				
Knurled levers:	03K	06K									

TRIM / CONTROL FINISH			
605: Bright Brass (US3)	721: Bright Brass - no Lacquer (US3A)	606: Satin Brass (US4)	728: Satin Brass - no Lacquer (US4A)
612: Satin Bronze (US10)	613: Satin Bronze-Oil Rubbed (US10B)	625: Bright Chrome(US26)	626: Satin Chrome (US26D)
693: Painted Black (SPBLK)			

MORTISE LOCK E7500		
LL: Less Lock	7500: Standard Mortise	E7500: Electric Unlocking

88 SERIES

605	606	611	612	613	619	622	625	626	626AM	628	629
US3	US4	US9	US10	US10B	US15	US19	US26	US26D	US26DAM	US28	US32
630	630AM	643e	689	691	693	695	706	710	711	721	728
US32D	US32DAM	-	SP28	SP10	SPBLK	SP313	SP4	313	315	US3A	US4A

MORTISE LOCK FINISH			
605: Bright Brass (US3)	721: Bright Brass - no Lacquer (US3A)	606: Satin Brass (US4)	728: Satin Brass - no Lacquer (US4A)
612: Satin Bronze (US10)	613: Satin Bronze-Oil Rubbed (US10B)	630: Satin Stainless (US32D)	693: Painted Black (SPBLK)
622: Matte Black (US19)	629: Bright Stainless Steel (US32)		

RODS FOR SURFACE / CONCEALED VERTICAL DEVICES ONLY			
OPR: One piece top rod	LBR: Less Bottom Rod	RG-27: Rod / Latch Guard	RGO: Rod Guard Only

SWITCH OPTIONS			
RX : Request to Exit			

ELECTRIC LOCKING			
E: Electric Locking			

STORM RATING			
HH: Wind and Impact - Hurricane Rated		HW: Wind Only - Hurricane Rated	

STRIKE SERIES			
LS: Less Strike	LTS: Less Top Strike	1409: Optional 88 Rim	1410: Optional Rim
1606: Optional Rim	1609: Optional Rim	1610: Optional Rim	268: Standard 88 Fire
299: Standard 88 Rim	575-2: Optional 8875 Mortise	575: Standard 8875 Mortise	576A: Optional. 8875 1-3/4
576B: Optional 8875 2-1/4			

BOTTOM STRIKE SERIES			
LBS (Less Bottom Strike)	248L-4 (Surface)	301L / 304L (Mortise)	385A (Adjustable Mortise)

STRIKE FINISH			
605: Bright Brass (US3)	606: Satin Brass (US4)	612: Satin Bronze (US10)	613: Satin Bronze-Oil Rubbed (US10B)
622: Matte Black (US19)	625: Bright Chrome (US26)	626: Satin Chrome (US26D)	629: Bright Stainless (US32)
630: Satin Stainless (US32D)	695: Duranodic Dark Bronze (313)	MD (e-Moly)	

CROSS BAR OPTIONS			
RCB: Reinforced Crossbar		KN: Knurled	

MISC DEVICE OPTIONS			
10WDA: #10WDA Cover Plate	CYL: Include Cylinder	FL: 8847-F Device	FL: 8827-F, not UL Fire application
LCP: Less Cover Plate	PL: Include Pullman Latch)	SNB: Include # of Sex Bolts	889R /889M /889V: 373L with Sex bolts Cover Plates

SLM BLOCKING			
SLM: SLM Blocking			

88 SERIES

605	606	611	612	613	619	622	625	626	626AM	628	629
US3	US4	US9	US10	US10B	US15	US19	US26	US26D	US26DAM	US28	US32
630	630AM	643e	689	691	693	695	706	710	711	721	728
US32D	US32DAM	-	SP28	SP10	SPBLK	SP313	SP4	313	315	US3A	US4A

SECURITY SCREWS

SEC: Include Security Screws

DOOR MATERIAL

ALD: Aluminum door

CP: Composite door

HMD: Hollow metal

WD: Wood door

DOOR THICKNESS

DT1-3/4: 1-3/4" Standard

DT2: 2" thickness

DT2-1/4: 2-1/4" thickness

DOOR APPLICATION

DE: Pair Double egress doors

PR: Pair of doors

SGL: Single door

MSV / MCV (Mortise Surface / Concealed Vert.)

88 SERIES

Rim devices

605	606	611	612	613	619	622	625	626	626AM	628	629
US3	US4	US9	US10	US10B	US15	US19	US26	US26D	US26DAM	US28	US32
630	630AM	643e	689	691	693	695	706	710	711	721	728
US32D	US32DAM	-	SP28	SPIO	SPBLK	SP313	SP4	313	315	US3A	US4A

ACN							PRICE BASED ON FINISH					Default trim, included	
Device type	Function	Fire	Finish	Device size	Handing	Lever design	605	619	625	622	606		
							626	613	612	643E			693
EXIT HARDWARE							3' DEVICE PRICING SHOWN. 4' ADD \$26.00 LIST						
88	EO ²	.	[]	[]			\$2,080	\$2,353	\$2,095	\$1,979	\$2,549	\$2,549	N/A
88	DT	.	[]	[]			\$2,452	\$2,751	\$2,578	\$2,265	\$3,032	\$3,032	880DT-R
88	NL	.	[]	[]	[]	[]	\$2,478	\$2,777	\$2,604	\$2,291	\$3,058	\$3,058	880NL-R [☞]
88	TP	.	[]	[]			\$2,494	\$2,795	\$2,674	\$2,374	\$3,128	\$3,128	880TP-R
88	TP-BE	.	[]	[]			\$2,494	\$2,795	\$2,674	\$2,374	\$3,128	\$3,128	880TP-BE-R
88	K	.	[]	[]			\$2,564	\$2,873	\$2,712	\$2,374	\$3,166	\$3,166	880K-R
88	K-BE	.	[]	[]			\$2,564	\$2,873	\$2,712	\$2,374	\$3,166	\$3,166	880K-BE-R
88	K-DT	.	[]	[]			\$2,564	\$2,873	\$2,712	\$2,374	\$3,166	\$3,166	880K-DT-R
88	K-NL	.	[]	[]			\$2,564	\$2,873	\$2,712	\$2,374	\$3,166	\$3,166	880K-NL-R
88	L	.	[]	[]	[]	[]	\$3,052	\$3,311	\$3,067	\$2,800	\$3,627	\$3,507	373L ^{1,3}
88	L-BE	.	[]	[]	[]	[]	\$3,002	\$3,261	\$3,017	\$2,750	\$3,577	\$3,457	373L-BE ^{1,3}
88	L-DT	.	[]	[]	[]	[]	\$2,975	\$3,234	\$2,990	\$2,723	\$3,550	\$3,430	373L-DT ^{1,3}
FIRE EXIT HARDWARE							3' DEVICE PRICING SHOWN. 4' ADD \$26.00 LIST						
88	EO ²	F	[]	[]			\$2,585	\$2,858	\$2,600	\$2,484	\$3,054	\$3,054	N/A
88	DT	F	[]	[]			\$2,957	\$3,256	\$3,083	\$2,770	\$3,537	\$3,537	880DT-R
88	NL	F	[]	[]	[]	[]	\$2,983	\$3,282	\$3,109	\$2,796	\$3,563	\$3,563	880NL-R [☞]
88	TP	F	[]	[]			\$2,999	\$3,300	\$3,179	\$2,879	\$3,633	\$3,633	880TP-R
88	TP-BE	F	[]	[]			\$2,999	\$3,300	\$3,179	\$2,879	\$3,633	\$3,633	880TP-BE-R
88	K	F	[]	[]			\$3,069	\$3,378	\$3,217	\$2,879	\$3,671	\$3,671	880K-R
88	K-BE	F	[]	[]			\$3,069	\$3,378	\$3,217	\$2,879	\$3,671	\$3,671	880K-BE-R
88	K-NL	F	[]	[]			\$3,069	\$3,378	\$3,217	\$2,879	\$3,671	\$3,671	880K-NL-R
88	L	F	[]	[]	[]	[]	\$3,557	\$3,816	\$3,572	\$3,305	\$4,132	\$4,012	373L ¹
88	L-BE	F	[]	[]	[]	[]	\$3,507	\$3,766	\$3,522	\$3,255	\$4,082	\$3,962	373L-BE ¹

² Consult factory for lead time.

¹ 889 cover plate is required for sex bolt applications using 373 lever controls, including Fire Rated Wood or Composite door application, and will be supplied at an additional price. Refer to page 163 for price by finish.

² Cylinder Plate for NLOP function - included with EO device.

³ 10WDA cover plate is required for 370 series controls on wood without sex bolts and will be supplied at an additional price. Refer to page 163 for price.

88-F Rim and all devices specified with lever trim are handed and not field reversible, specify handing RHR or LHR.

DEFAULT ATTRIBUTES

Pricing includes default options shown below. Additional options and configurations available.

Cylinders:	Sex bolts	Door thickness	Center line
Not included	Not included	1-3/4"	39-13/16"

Strike(s):

- Exit hardware:
- Includes 299 strike
- Fire exit hardware:
- Includes 268 strike

88 SERIES

Surface vertical rod devices (27)

605	606	611	612	613	619	622	625	626	626AM	628	629
US3	US4	US9	US10	US10B	US15	US19	US26	US26D	US26DAM	US28	US32
630	630AM	643e	689	691	693	695	706	710	711	721	728
US32D	US32DAM	-	SP28	SPIO	SPBLK	SP313	SP4	313	315	US3A	US4A

ACN							PRICE BASED ON FINISH					Default trim, included	
Device type	Function	Fire	Finish	Device size	Handing	Lever design	605	619	625	622	606		
							626	613	612	643E			693
EXIT HARDWARE							3' DEVICE PRICING SHOWN. 4' ADD \$26.00 LIST						
8827	EO	[]	[]	[]	[]	[]	\$2,904	\$3,100	\$2,781	\$2,641	\$3,413	\$3,413	N/A
8827	DT	[]	[]	[]	[]	[]	\$3,276	\$3,498	\$3,264	\$2,927	\$3,896	\$3,896	880DT-V/M
8827	TP	[]	[]	[]	[]	[]	\$3,318	\$3,542	\$3,360	\$3,036	\$3,992	\$3,992	880TP-V
8827	TP-BE	[]	[]	[]	[]	[]	\$3,318	\$3,542	\$3,360	\$3,036	\$3,992	\$3,992	880TP-BE-V
8827	TP-NL	[]	[]	[]	[]	[]	\$3,318	\$3,542	\$3,360	\$3,036	\$3,992	\$3,992	880TP-V
8827	K	[]	[]	[]	[]	[]	\$3,388	\$3,620	\$3,398	\$3,036	\$4,030	\$4,030	880K-V
8827	K-BE	[]	[]	[]	[]	[]	\$3,388	\$3,620	\$3,398	\$3,036	\$4,030	\$4,030	880K-BE-V
8827	K-DT	[]	[]	[]	[]	[]	\$3,388	\$3,620	\$3,398	\$3,036	\$4,030	\$4,030	880K-DT-V
8827	K-NL	[]	[]	[]	[]	[]	\$3,388	\$3,620	\$3,398	\$3,036	\$4,030	\$4,030	880K-V
8827	L	[]	[]	[]	[]	[]	\$3,876	\$4,058	\$3,753	\$3,462	\$4,491	\$4,371	373L ¹
8827	L-BE	[]	[]	[]	[]	[]	\$3,826	\$4,008	\$3,703	\$3,412	\$4,441	\$4,321	373L-BE ¹
8827	L-DT	[]	[]	[]	[]	[]	\$3,799	\$3,981	\$3,676	\$3,385	\$4,414	\$4,294	373L-DT ¹
8827	TL	[]	[]	[]	[]	[]	\$4,324	\$4,546	\$4,392	\$3,830	\$5,024	\$4,944	880DT-V/M/377T ²
8827	TL-BE	[]	[]	[]	[]	[]	\$4,265	\$4,487	\$4,333	\$3,771	\$4,965	\$4,885	880DT-V/M/377T-BE ²
FIRE EXIT HARDWARE							3' DEVICE PRICING SHOWN. 4' ADD \$26.00 LIST						
8827	EO	F	[]	[]	[]	[]	\$3,925	\$4,121	\$3,802	\$3,662	\$4,434	\$4,434	N/A
8827	DT	F	[]	[]	[]	[]	\$4,297	\$4,519	\$4,285	\$3,948	\$4,917	\$4,917	880DT-V/M
8827	TP	F	[]	[]	[]	[]	\$4,339	\$4,563	\$4,381	\$4,057	\$5,013	\$5,013	880TP-V
8827	TP-BE	F	[]	[]	[]	[]	\$4,339	\$4,563	\$4,381	\$4,057	\$5,013	\$5,013	880TP-V
8827	TP-NL	F	[]	[]	[]	[]	\$4,339	\$4,563	\$4,381	\$4,057	\$5,013	\$5,013	880TP-BE-V
8827	K	F	[]	[]	[]	[]	\$4,409	\$4,641	\$4,419	\$4,057	\$5,051	\$5,051	880K-V
8827	K-BE	F	[]	[]	[]	[]	\$4,409	\$4,641	\$4,419	\$4,057	\$5,051	\$5,051	880K-BE-V
8827	K-NL	F	[]	[]	[]	[]	\$4,409	\$4,641	\$4,419	\$4,057	\$5,051	\$5,051	880K-V
8827	L	F	[]	[]	[]	[]	\$4,897	\$5,079	\$4,774	\$4,483	\$5,512	\$5,392	373L ¹
8827	L-BE	F	[]	[]	[]	[]	\$4,847	\$5,029	\$4,724	\$4,433	\$5,462	\$5,342	373L-BE ¹
8827	TL	F	[]	[]	[]	[]	\$5,345	\$5,567	\$5,413	\$4,851	\$6,045	\$5,965	880DT-V/M/377T ²
8827	TL-BE	F	[]	[]	[]	[]	\$5,286	\$5,508	\$5,354	\$4,792	\$5,986	\$5,906	880DT-V/M/377T-BE ²

Consult factory for lead time.

¹ Composite Doors - 889 cover plate is required for sex bolt applications using 373 lever controls and will be supplied at an additional price. Refer to page 163 for price by finish.

² Wood Doors - 10WDA cover plate is required for the 370 series controls and will be supplied at an additional, \$75.00 list add.

Handing - Lever trim is handed and not field reversible, specify handing RHR or LHR.

DEFAULT ATTRIBUTES

Pricing includes default options shown below. Additional options and configurations available.

Cylinders:	Sex bolts	Door thickness	Center line
Not included	Not included	1-3/4"	39-13/16"

Strike(s):

Exit hardware:

- Includes 299, 248L-4 and 304L strikes

Fire exit hardware:

- Includes 304L strike

88 SERIES

605	606	611	612	613	619	622	625	626	626AM	628	629
US3	US4	US9	US10	US10B	US15	US19	US26	US26D	US26DAM	US28	US32
630	630AM	643e	689	691	693	695	706	710	711	721	728
US32D	US32DAM	-	SP28	SP10	SPBLK	SP313	SP4	313	315	US3A	US4A

Concealed vertical rod devices (47)

ACN							PRICE BASED ON FINISH						Default trim, included				
Device type	Function	Fire	Finish	Device size	Handing	Lever design	605	619	625	622	626	613		612	606	643E	693
							626	613	612	606							
FIRE EXIT HARDWARE							3' DEVICE PRICING SHOWN. 4' ADD \$26.00 LIST										
8847	. EO	. F	[]	[]			\$3,600	\$3,796	\$3,477	\$3,337	\$4,109	\$4,109					N/A
8847	. L	. F	[]	[]	[]	[]	\$4,645	\$4,827	\$4,522	\$4,231	\$5,260	\$5,140					371L
8847	. L-BE	. F	[]	[]	[]	[]	\$4,598	\$4,780	\$4,475	\$4,184	\$5,213	\$5,093					371L-BE
8847	. TL	. F	[]	[]	[]	[]	\$5,018	\$5,240	\$5,086	\$4,524	\$5,718	\$5,638					880DT-V-SA/376T ²
8847	. TL-BE	. F	[]	[]	[]	[]	\$4,961	\$5,183	\$5,029	\$4,467	\$5,661	\$5,581					880DT-V-SA/376T-BE ²

☞ Consult factory for lead time.

Handing - 8847-F and all devices specified with lever trim are handed and not field reversible, specify handing RHR or LHR.

Dogging - 8847-F device is available with dogging less fire label at no additional charge. Specify 8847-F with dogging. Consult factory for lead time.

DEFAULT ATTRIBUTES

Pricing includes default options shown below. Additional options and configurations available.

Cylinders:	Sex bolts	Door thickness	Center line
Not included	Not included	1-3/4"	39-13/16"

Strike(s):

- Fire exit hardware:
- Hollow metal doors only
 - Includes 301L strike

88 SERIES

605	606	611	612	613	619	622	625	626	626AM	628	629
US3	US4	US9	US10	US10B	US15	US19	US26	US26D	US26DAM	US28	US32
630	630AM	643e	689	691	693	695	706	710	711	721	728
US32D	US32DAM	-	SP28	SPIO	SPBLK	SP313	SP4	313	315	US3A	US4A

Mortise lock devices (75)

ACN							PRICE BASED ON FINISH					Default trim, included	
Device type	Function	Fire	Finish	Device size	Handing	Lever design	605	619	625	622			
							626	613	612	606			643E
EXIT HARDWARE							3' DEVICE PRICING SHOWN. 4' ADD \$26.00 LIST						
8875	. EO	. []	. []				\$2,765	\$3,388	\$2,851	\$2,737	\$3,267	\$3,267	N/A
8875	. DT	. []	. []				\$3,137	\$3,786	\$3,334	\$3,023	\$3,750	\$3,750	880DT-V/M
8875	. NL	. []	. []	. []			\$3,163	\$3,812	\$3,360	\$3,049	\$3,776	\$3,776	880NL-M ¹
8875	. TP	. []	. []				\$3,179	\$3,830	\$3,430	\$3,132	\$3,846	\$3,846	880TP-M
8875	. TP-BE	. []	. []				\$3,179	\$3,830	\$3,430	\$3,132	\$3,846	\$3,846	880TP-BE-M
8875	. K	. []	. []				\$3,249	\$3,908	\$3,468	\$3,132	\$3,884	\$3,884	880K-M
8875	. K-BE	. []	. []				\$3,249	\$3,908	\$3,468	\$3,132	\$3,884	\$3,884	880K-BE-M
8875	. K-DT	. []	. []				\$3,249	\$3,908	\$3,468	\$3,132	\$3,884	\$3,884	880K-DT-M
8875	. L	. []	. []	. []	. []		\$3,737	\$4,346	\$3,823	\$3,558	\$4,345	\$4,225	373L ¹
8875	. L-BE	. []	. []	. []	. []		\$3,687	\$4,296	\$3,773	\$3,508	\$4,295	\$4,175	373L-BE ¹
8875	. L-DT	. []	. []	. []	. []		\$3,660	\$4,269	\$3,746	\$3,481	\$4,268	\$4,148	373L-DT ¹
FIRE EXIT HARDWARE							3' DEVICE PRICING SHOWN. 4' ADD \$26.00 LIST						
8875	. EO	. F	. []	. []			\$3,019	\$3,642	\$3,105	\$2,991	\$3,521	\$3,521	N/A
8875	. DT	. F	. []	. []			\$3,391	\$4,040	\$3,588	\$3,277	\$4,004	\$4,004	880DT-V/M
8875	. NL	. F	. []	. []	. []		\$3,417	\$4,066	\$3,614	\$3,303	\$4,030	\$4,030	880NL-M
8875	. TP	. F	. []	. []			\$3,433	\$4,084	\$3,684	\$3,386	\$4,100	\$4,100	880TP-M
8875	. TP-BE	. F	. []	. []			\$3,433	\$4,084	\$3,684	\$3,386	\$4,100	\$4,100	880TP-BE-M
8875	. K	. F	. []	. []			\$3,503	\$4,162	\$3,722	\$3,386	\$4,138	\$4,138	880K-M
8875	. K-BE	. F	. []	. []			\$3,503	\$4,162	\$3,722	\$3,386	\$4,138	\$4,138	880K-BE-M
8875	. L	. F	. []	. []	. []	. []	\$3,991	\$4,600	\$4,077	\$3,812	\$4,599	\$4,479	373L ¹
8875	. L-BE	. F	. []	. []	. []	. []	\$3,941	\$4,550	\$4,027	\$3,762	\$4,549	\$4,429	373L-BE ¹

² Consult factory for lead time.

¹ Composite Doors - 889 cover plate is required for sex bolt applications using 373 lever controls and will be supplied at an additional price. Refer to page 163 for price by finish.

Handing - 8875, 8875-F and all devices specified with lever trim are handed and not field reversible, specify handing RHR or LHR.

DEFAULT ATTRIBUTES

Pricing includes default options shown below. Additional options and configurations available.

Cylinders:	Sex bolts	Door thickness	Center line
Not included	Not included	1-3/4"	39-13/16"

Strike(s):

Exit hardware:

- Includes 575 strike

Fire exit hardware:

- Includes 575 strike

OPTIONS

605	606	611	612	613	619	622	625	626	626AM	628	629
US3	US4	US9	US10	US10B	US15	US19	US26	US26D	US26DAM	US28	US32
630	630AM	643e	689	691	693	695	706	710	711	721	728
US32D	US32DAM	-	SP28	SP10	SPBLK	SP313	SP4	313	315	US3A	US4A

SWITCHES	Specify (Prefix)	Price adjustment
Request to Exit - Crossbar monitor switch in end case ▪ Factory install only	RX	\$365.00

Less Bottom Rod	Specify (Suffix)	Price adjustment
8827-LBR panic only	LBR	-\$252.00

PULLMAN LATCHES - Not for use with fire exit hardware, consult factory for lead time	Specify	Price adjustment
8827-LBR with PL Top Latch, for use with e-strike. Shipped less label.	ES	\$162.00
8827 Device PL Top and PL Bottom	PL	\$324.00

ELECTRIC UNLOCKING	Specify (Prefix)	Price adjustment
<ul style="list-style-type: none"> Electric unlocking of outside lever for all 8875 mortise devices Available with 8875 mortise K, K-BE, L-BE, TP or TP-BE lever trim only For 24VAC installation a SO24 Rectifier Kit will be supplied at an additional \$61.00 list add. Specify FAIL SECURE (FSE) or FAIL SAFE (FS). SO rectifier kit intended for fail secure / momentary use only. Contact product support for assistance. 	E	\$909.00
<ul style="list-style-type: none"> Electric unlocking of outside 88 Series lever or thumbturn controls Available with 371L-BE, 373L-BE, 376T-BE, 377T-BE functions only 24VDC furnished standard Prefix Lever or Thumbturn Control with "E" Example: E371L-BE 		\$909.00

STORM RATING

HURRICANE DEVICE - USE WITH APPROVED ALLEGION DOOR APPLICATIONS

Specify HH (Wind and Impact) or HW (Wind-Only) prefix when ordering devices or mullions for hurricane applications. If application is unknown, specify HH which will satisfy the requirements for both applications. HH option only available for select series and models. HH/HW devices will be furnished with strikes shown in charts (and with through bolts if HH product) and are price-adjusted as indicated. Mullions priced separately.

HH (WIND AND IMPACT)

Model	Door mode	Mullion	Standard strike	Specify (Prefix)	Price adjustment
88-F Rim	SGL	-	268	HH	\$152.00
88-F Rim	PR	HH9954	468	HH	\$122.00
8875	SGL	-	575	HH	\$152.00
8875-F	SGL	-	575	HH	\$152.00

HW (WIND ONLY)

Model	Door mode	Mullion	Standard strike	Specify (Prefix)	Price adjustment
88 Rim	SGL	-	299	HW	\$0.00
88 Rim	PR	4954 or KR4954	299	HW	\$0.00
88-F Rim	SGL	-	268	HW	\$0.00
88-F Rim	PR	9954 or KR9954	268	HW	\$0.00
8827	SGL or PR	-	Top: 299 Bottom: 304L	HW	-\$82.00
8875	SGL	-	575	HW	\$0.00
8875-F	SGL	-	575	HW	\$0.00

CROSSBAR OPTIONS

	Specify (Prefix)	Price adjustment
Reinforced Crossbar	RCB	\$150.00
Knurled Crossbar (KN must be ordered as 4' device; cut bar as needed)	KN	\$173.00

FLUSH TRANSOM INSTALLATION

	Specify (Prefix)	Price adjustment
8827-F Device (Not a UL Fire Exit Hardware listed application)	FL	\$571.00
8847-F Device		\$138.00

PARTS AND ACCESSORIES

605	606	611	612	613	619	622	625	626	626AM	628	629
US3	US4	US9	US10	US10B	US15	US19	US26	US26D	US26DAM	US28	US32
630	630AM	643e	689	691	693	695	706	710	711	721	728
US32D	US32DAM	-	SP28	SP10	SPBLK	SP313	SP4	313	315	US3A	US4A

BACKPLATE CONVERSION KITS

Description	Specify		Non-finished	613, 626	612	606	605, 619, 622, 625, 693
	Part number	Finish					
88CK-NL Converts TP,K to NL - Panic	050101	.[Finish]	-	\$80.00	\$82.00	\$75.00	\$86.00
88CK-TP Converts EO,DT,NL,K to TP - Panic	050102	.[Finish]	-	\$98.00	\$104.00	\$94.00	\$112.00
88CK-K/L Converts EO,DT,NL,TP to K or L - Panic	050103	.[Finish]	-	\$171.00	\$179.00	\$165.00	\$188.00
88CK-NL-F Converts TP,K to NL - Fire	050106	.[Finish]	-	\$90.00	\$93.00	\$88.00	\$94.00
88CK-TP-F Converts EO,DT,NL,K to TP - Fire	050107	.[Finish]	-	\$112.00	\$118.00	\$98.00	\$130.00
88CK-K/L-F Converts EO,DT,NL,TP to K or L - Fire	050108	.[Finish]	-	\$171.00	\$179.00	\$168.00	\$188.00
8827CK-TP Converts EO,DT,K to TP - Panic or Fire	050104	-	\$307.00	-	-	-	-
8827CK-K/L-K/L-F Converts EO,DT,TP to K or L - Panic or Fire	050200	-	\$305.00	-	-	-	-
8827CK-K-NL/K-NL-F	050201	-	\$340.00	-	-	-	-
8827CK-TP-NL/TP-NL-F	050202	-	\$309.00	-	-	-	-
8827CK-EO/DT/TL	050447	-	\$51.00	-	-	-	-

CENTER CASE KITS (INCLUDES MOUNTING SCREWS)

Description	Specify		Non-finished	613, 626	612	606	605, 619, 622, 625, 693
	Part number	Finish					
88EO/DT/NL Rim Center Case Kit	050409	.[Finish]	-	\$997.00	\$1,043.00	\$838.00	\$1,090.00
88TP Rim Center Case Kit	050410	.[Finish]	-	\$997.00	\$1,043.00	\$838.00	\$1,090.00
88K/L RHR Center Case Kit	050411	.[Finish]	-	\$997.00	\$1,043.00	\$838.00	\$1,090.00
88K/L LHR Center Case Kit	050412	.[Finish]	-	\$997.00	\$1,043.00	\$838.00	\$1,090.00
8875 RHR Center Case Kit	050413	.[Finish]	-	\$801.00	\$821.00	\$668.00	\$875.00
8875 LHR Center Case Kit	050414	.[Finish]	-	\$801.00	\$821.00	\$668.00	\$875.00
8827EO/DT/TL Center Case Kit	050415	.[Finish]	-	\$528.00	\$540.00	\$492.00	\$578.00
8827TP Center Case Kit	050416	.[Finish]	-	\$702.00	\$718.00	\$613.00	\$730.00
8827K/L Center Case Kit	050417	.[Finish]	-	\$880.00	\$924.00	\$754.00	\$957.00
8827TP-NL Center Case Kit	050418	.[Finish]	-	\$702.00	\$718.00	\$613.00	\$730.00
8827K-NL Center Case Kit	050419	.[Finish]	-	\$880.00	\$924.00	\$754.00	\$957.00
8827EO/DT/TL-LBR Center Case Kit	47555096	.[Finish]	-	\$528.00	\$540.00	\$492.00	\$578.00
8827TP-LBR Center Case Kit	47555172	.[Finish]	-	\$702.00	\$718.00	\$613.00	\$730.00
8827K/L-LBR Center Case Kit	47555173	.[Finish]	-	\$880.00	\$924.00	\$754.00	\$957.00
8827TP-NL-LBR Center Case Kit	47555176	.[Finish]	-	\$702.00	\$718.00	\$613.00	\$730.00
8827K-NL-LBR Center Case Kit	47555178	.[Finish]	-	\$880.00	\$924.00	\$754.00	\$957.00
8875-F RHR Center Case Kit	050420	.[Finish]	-	\$924.00	\$968.00	\$757.00	\$1,000.00
8875-F LHR Center Case Kit	050421	.[Finish]	-	\$924.00	\$968.00	\$757.00	\$1,000.00
8847-F RHR Center Case Kit	050422	.[Finish]	-	\$924.00	\$968.00	\$757.00	\$1,000.00
8847-F LHR Center Case Kit	050423	.[Finish]	-	\$924.00	\$968.00	\$757.00	\$1,000.00
88EO-F/NL-F RHR Center Case Kit	050424	.[Finish]	-	\$1,254.00	\$1,484.00	\$1,484.00	\$1,568.00
88EO-F/NL-F LHR Center Case Kit	050425	.[Finish]	-	\$1,254.00	\$1,484.00	\$1,484.00	\$1,568.00
88TP-F RHR Center Case Kit	050426	.[Finish]	-	\$1,300.00	\$1,541.00	\$1,541.00	\$1,629.00
88TP-F LHR Center Case Kit	050427	.[Finish]	-	\$1,300.00	\$1,541.00	\$1,541.00	\$1,629.00

PARTS AND ACCESSORIES

605	606	611	612	613	619	622	625	626	626AM	628	629
US3	US4	US9	US10	US10B	US15	US19	US26	US26D	US26DAM	US28	US32
630	630AM	643e	689	691	693	695	706	710	711	721	728
US32D	US32DAM	-	SP28	SP10	SPBLK	SP313	SP4	313	315	US3A	US4A

CENTER CASE KITS (INCLUDES MOUNTING SCREWS)

Description	Specify		Non-finished	613, 626	612	606	605, 619, 622, 625, 693
	Part number	Finish					
88K/L-F RHR Center Case Kit	050428	.[Finish]	-	\$1,300.00	\$1,541.00	\$1,541.00	\$1,629.00
88K/L-F LHR Center Case Kit	050429	.[Finish]	-	\$1,300.00	\$1,541.00	\$1,541.00	\$1,629.00
8827EO-F/TL-F Center Case Kit	050430	.[Finish]	-	\$682.00	\$704.00	\$563.00	\$739.00
8827TP-F Center Case Kit	050431	.[Finish]	-	\$987.00	\$1,035.00	\$823.00	\$1,081.00
8827K/L-F Center Case Kit	050432	.[Finish]	-	\$1,037.00	\$1,086.00	\$875.00	\$1,134.00
8827TP-NL-F Center Case Kit	050433	.[Finish]	-	\$957.00	\$1,005.00	\$786.00	\$1,042.00
8827K-NL-F Center Case Kit	050434	.[Finish]	-	\$1,058.00	\$1,086.00	\$885.00	\$1,153.00

RETROFIT COVER PLATES (FOR FALCON XX AND CR ED600)

Description	Specify		Non-finished	689, 695
	Part number	Finish		
Cover Plate Pkg, 88 MORT/SVR	953001	.[Finish]	-	\$50.00
Cover Plate Pkg, 88 RIM	953002	.[Finish]	-	\$50.00

CENTER CASE PARTS - RIM

Description	Specify		Non-finished	613, 626	612	606	605, 619, 622, 625, 693
	Part number	Finish					
88 Thumbpiece Lift Replacement Kit*	050019	-	\$112.00	-	-	-	-
88 Rim Auxiliary Backplate	050260	.[Finish]	-	\$73.00	\$76.00	\$73.00	\$76.00
88-F Master Cam RH	050273	-	\$98.00	-	-	-	-
88-F Master Cam LH	050274	-	\$98.00	-	-	-	-
88-F Auxiliary Bolt RH	050275	-	\$80.00	-	-	-	-
88-F Auxiliary Bolt LH	050276	-	\$80.00	-	-	-	-
88 Cylinder Anchor Plate	050331	-	\$18.00	-	-	-	-
88 Latch Bolt w/Axle Kit	050497	-	\$115.00	-	-	-	-
88-F Latch Bolt w/Axle Kit	050498	-	\$122.00	-	-	-	-
88 Rim Latch Retainer Plate	050499	-	\$19.00	-	-	-	-
88 Rim Latch Tail, Spring, Rivet Kit	050500	-	\$76.00	-	-	-	-
88 Rim Latch Tail Spring Pkg/10	050393	-	\$18.00	-	-	-	-
88 Rim Master Cam	050501	-	\$42.00	-	-	-	-
88NL Cylinder Cam	050502	-	\$45.00	-	-	-	-
88NL-F Cylinder Cam	050503	-	\$42.00	-	-	-	-
88K/L-F Knob Cam Lift	050504	-	\$70.00	-	-	-	-
88K/L-F Cylinder Cam	050505	-	\$42.00	-	-	-	-
88K/L-F Knob Cam Bracket	050506	-	\$138.00	-	-	-	-
88TP-F Cylinder Cam	050508	-	\$24.00	-	-	-	-
88 Rim Latch Bolt Axle Pkg/4	090001	-	\$19.00	-	-	-	-

* For 88TP/TP-F devices shipped after June 2000. For devices shipped before June 2000, replace 050102 for 88TP or 050107 for 88TP-F.

PARTS AND ACCESSORIES

605	606	611	612	613	619	622	625	626	626AM	628	629
US3	US4	US9	US10	US10B	US15	US19	US26	US26D	US26DAM	US28	US32
630	630AM	643e	689	691	693	695	706	710	711	721	728
US32D	US32DAM	-	SP28	SP10	SPBLK	SP313	SP4	313	315	US3A	US4A

CENTER CASE PARTS - RIM

Description	Specify		Non-finished	613, 626	612	606	605, 619, 622, 625, 693
	Part number	Finish					
88 Rim Center Case Rivet Pkg/10	090002	-	\$19.00	-	-	-	-
88-F Rim Gravity Dog Spring Pkg/5	090009	-	\$19.00	-	-	-	-
88K/L-F Retaining Ring Pkg/10	090015	-	\$19.00	-	-	-	-
88-F Auxiliary Bolt Return Spring Pkg/5	090017	-	\$19.00	-	-	-	-
Hex Socket Wrench 5/32"	113853	-	\$16.00	-	-	-	-
88 C/C or E/C Mtg Pkg (CS and MS)	900503	.[Finish]	-	\$20.00	\$20.00	\$20.00	\$20.00
88 C/C or E/C Mtg Pkg (CS Screws)	900504	.[Finish]	-	\$19.00	\$19.00	\$19.00	\$19.00
88 C/C or E/C Mtg Pkg (MS Scr 1-3/4" Dr)	900505	.[Finish]	-	\$18.00	\$18.00	\$18.00	\$18.00
88 C/C or E/C Mtg Pkg (MS Scr 2-1/4" Dr)	900506	.[Finish]	-	\$18.00	\$18.00	\$18.00	\$18.00
88 Rim Latch Retainer Plate Screw Pkg/10	900610	-	\$19.00	-	-	-	-
88 Backplate Screw Pkg/4	900613	-	\$19.00	-	-	-	-

* For 88TP/TP-F devices shipped after June 2000. For devices shipped before June 2000, replace 050102 for 88TP or 050107 for 88TP-F.

CENTER CASE PARTS - SURFACE VERTICAL

Description	Specify		Non-finished	613, 626	612	606	605, 619, 622, 625, 693
	Part number	Finish					
88 Cylinder Anchor Plate	050331	-	\$18.00	-	-	-	-
8827/27-F Rod Control	050446	-	\$138.00	-	-	-	-
8827-LBR Rod Control	47555180	-	\$138.00	-	-	-	-
8827K/K-NL/TP/TP-NL/-F Cylinder Cam	050448	-	\$42.00	-	-	-	-
8827K/K-NL/-F Knob Hub	050449	-	\$153.00	-	-	-	-
8827K-NL/TP-NL Backplate Pin Pkg/2	090012	-	\$33.00	-	-	-	-
8827/27-F Rod Control Pin Pkg/2	090016	-	\$19.00	-	-	-	-
88 C/C or E/C Mtg Pkg (CS and MS)	900503	.[Finish]	-	\$20.00	\$20.00	\$20.00	\$20.00
88 C/C or E/C Mtg Pkg (CS Screws)	900504	.[Finish]	-	\$19.00	\$19.00	\$19.00	\$19.00
88 C/C or E/C Mtg Pkg (MS Scr 1-3/4" Dr)	900505	.[Finish]	-	\$18.00	\$18.00	\$18.00	\$18.00
88 C/C or E/C Mtg Pkg (MS Scr 2-1/4" Dr)	900506	.[Finish]	-	\$18.00	\$18.00	\$18.00	\$18.00
8827 Backplate Screw Pkg	900615	-	\$19.00	-	-	-	-

CENTER CASE PARTS - CONCEALED VERTICAL/MORTISE

Description	Specify		Non-finished	613, 626	612	606	605, 619, 622, 625, 693
	Part number	Finish					
8847-F/75/75-F Latch Control LH	050209	-	\$277.00	-	-	-	-
8847-F/75/75-F Latch Control RH	050210	-	\$277.00	-	-	-	-
8847-F/75/75-F Backplate w/Screws	050211	-	\$24.00	-	-	-	-
88 Cylinder Anchor Plate	050331	-	\$18.00	-	-	-	-
8847/75-F Flat Point Set Screw Pkg/5	090013	-	\$22.00	-	-	-	-
8847-F/75/75-F C/Case Spring Pkg/2	090014	-	\$19.00	-	-	-	-
88 C/C or E/C Mtg Pkg (CS and MS)	900503	.[Finish]	-	\$20.00	\$20.00	\$20.00	\$20.00

PARTS AND ACCESSORIES

605	606	611	612	613	619	622	625	626	626AM	628	629
US3	US4	US9	US10	US10B	US15	US19	US26	US26D	US26DAM	US28	US32
630	630AM	643e	689	691	693	695	706	710	711	721	728
US32D	US32DAM	-	SP28	SP10	SPBLK	SP313	SP4	313	315	US3A	US4A

CENTER CASE PARTS - CONCEALED VERTICAL/MORTISE

Description	Specify		Non-finished	613, 626	612	606	605, 619, 622, 625, 693
	Part number	Finish					
88 C/C or E/C Mtg Pkg (CS Screws)	900504	.[Finish]	-	\$19.00	\$19.00	\$19.00	\$19.00
88 C/C or E/C Mtg Pkg (MS Scr 1-3/4" Dr)	900505	.[Finish]	-	\$18.00	\$18.00	\$18.00	\$18.00
88 C/C or E/C Mtg Pkg (MS Scr 2-1/4" Dr)	900506	.[Finish]	-	\$18.00	\$18.00	\$18.00	\$18.00
8827 Backplate Screw Pkg	900615	-	\$19.00	-	-	-	-

CROSSBARS

Description	Specify		Non-finished	613, 626	612	606	605, 619, 622, 625, 693
	Part number	Finish					
42" Standard Crossbar Kit	050004	.[Finish]	-	\$322.00	\$332.00	\$322.00	\$340.00
42" Knurled Crossbar Kit	050005	.[Finish]	-	\$521.00	\$530.00	\$521.00	\$562.00
37" Crossbar Reinforcement Kit	050459	-	\$175.00	-	-	-	-

END CASE

Description	Specify		Non-finished	613, 626	612	606	605, 619, 622, 625, 693
	Part number	Finish					
88 R/M/V End Case Kit	050435	.[Finish]	-	\$340.00	\$369.00	\$289.00	\$392.00
8827-F/8875-F/8847-F End Case Kit	050436	.[Finish]	-	\$461.00	\$480.00	\$390.00	\$515.00
88-F Rim End Case Kit	050437	.[Finish]	-	\$405.00	\$437.00	\$340.00	\$474.00
88 End Case Spring Pkg/10	090080	-	\$76.00	-	-	-	-
88 End Case Spring Pkg/2	090003	-	\$20.00	-	-	-	-
88 End Case Spring Stop Kit	050451	-	\$24.00	-	-	-	-
88-F End Case Spring Stop Kit	050452	-	\$24.00	-	-	-	-
88/88-F End Case Spring Tube	050476	-	\$19.00	-	-	-	-
88/88-F Spring Tube Bracket w/Screws Kit	050477	-	\$19.00	-	-	-	-
88 C/C or E/C Mtg Pkg (CS and MS)	900503	.[Finish]	-	\$20.00	\$20.00	\$20.00	\$20.00
88 C/C or E/C Mtg Pkg (CS Screws)	900504	.[Finish]	-	\$19.00	\$19.00	\$19.00	\$19.00
88 C/C or E/C Mtg Pkg (MS Scr 1-3/4" Dr)	900505	.[Finish]	-	\$18.00	\$18.00	\$18.00	\$18.00
88 C/C or E/C Mtg Pkg (MS Scr 2-1/4" Dr)	900506	.[Finish]	-	\$18.00	\$18.00	\$18.00	\$18.00

LEVER ARMS

Description	Specify		Non-finished	613, 626	612	606	605, 619, 622, 625, 693
	Part number	Finish					
88 R/M/V RH Lever Arm Kit	050438	.[Finish]	-	\$270.00	\$283.00	\$228.00	\$289.00
88 R/M/V LH Lever Arm Kit	050439	.[Finish]	-	\$270.00	\$283.00	\$228.00	\$289.00
88-F Rim RH Lever Arm Kit	050440	.[Finish]	-	\$367.00	\$376.00	\$322.00	\$390.00
88-F Rim LH Lever Arm Kit	050441	.[Finish]	-	\$367.00	\$376.00	\$322.00	\$390.00
8827-F/47-F RH Lever Arm Kit	050442	.[Finish]	-	\$367.00	\$376.00	\$322.00	\$390.00
8827-F/47-F LH Lever Arm Kit	050443	.[Finish]	-	\$367.00	\$376.00	\$322.00	\$390.00

PARTS AND ACCESSORIES

605	606	611	612	613	619	622	625	626	626AM	628	629
US3	US4	US9	US10	US10B	US15	US19	US26	US26D	US26DAM	US28	US32
630	630AM	643e	689	691	693	695	706	710	711	721	728
US32D	US32DAM	-	SP28	SPIO	SPBLK	SP313	SP4	313	315	US3A	US4A

LEVER ARMS

Description	Specify		Non-finished	613, 626	612	606	605, 619, 622, 625, 693
	Part number	Finish					
8875-F RH Lever Arm Kit	050444	.[Finish]	-	\$367.00	\$376.00	\$322.00	\$390.00
8875-F LH Lever Arm Kit	050445	.[Finish]	-	\$367.00	\$376.00	\$322.00	\$390.00
Axle Security Pin Pkg/50	033022	-	\$79.00	-	-	-	-
Axle Security Pin Pkg/10	090007	-	\$24.00	-	-	-	-
Dog Screw Pkg/2	090004	-	\$31.00	-	-	-	-
Dog Screw Pkg/10	090083	-	\$104.00	-	-	-	-
227 Dog Key 5/32" Pkg/2	090005	-	\$30.00	-	-	-	-
227 Dog Key 5/32" Pkg/10	090085	-	\$101.00	-	-	-	-
Lever Arm Axles Pkg/2	090006	-	\$45.00	-	-	-	-
Lever Arm Axles Pkg/10	090082	-	\$208.00	-	-	-	-
Wedgetite Screw Pkg/2	090008	-	\$16.00	-	-	-	-
Wedgetite Screws Pkg/30	090081	-	\$76.00	-	-	-	-
Crossbar Tube Attaching Wedge Pkg/2	090020	-	\$19.00	-	-	-	-
Crossbar Tube Attaching Ring Pkg/2	090021	-	\$24.00	-	-	-	-
88 Lever Arm Axle Package	103865	-	\$98.00	-	-	-	-

VERTICAL LATCHES

Description	Specify		Non-finished	613, 626	612	606	605, 619, 622, 625, 693
	Part number	Finish					
8827 LR Top Latch Kit Less Cover	050460	-	\$293.00	-	-	-	-
8827 LR Bottom Latch Kit Less Cover	050461	-	\$293.00	-	-	-	-
8827-F Top Latch Kit Less Cover	050462	-	\$337.00	-	-	-	-
8827-F Bottom Latch Kit Less Cover	050463	-	\$337.00	-	-	-	-
8827 PL Top Latch Kit Less Cover	050471	-	\$196.00	-	-	-	-
8827 PL Bottom Latch Kit Less Cover	050472	-	\$196.00	-	-	-	-
8827-F/47-F Soffit Latch Kit	114141	-	\$292.00	-	-	-	-
8827 LR Top Latch Kit w/Cover	050466	.[Finish]	-	\$434.00	\$448.00	\$434.00	\$462.00
8827 LR Bottom Latch Kit w/Cover	050467	.[Finish]	-	\$434.00	\$448.00	\$434.00	\$462.00
8827-F Top Latch Kit w/Cover	050468	.[Finish]	-	\$531.00	\$551.00	\$524.00	\$598.00
8827-F Bottom Latch Kit w/Cover	050469	.[Finish]	-	\$531.00	\$551.00	\$524.00	\$598.00
8827 PL Top Latch Kit w/Cover	050473	.[Finish]	-	\$337.00	\$347.00	\$324.00	\$401.00
8827 PL Bottom Latch Kit w/Cover	050479	.[Finish]	-	\$337.00	\$347.00	\$324.00	\$401.00
8827-F Flush Transom Latch Kit w/Cover	050480	.[Finish]	-	\$551.00	\$593.00	\$551.00	\$617.00
8827 Latch Cover Kit	050464	.[Finish]	-	\$122.00	\$132.00	\$122.00	\$153.00
8827-F Top Latch Cover Kit	050465	.[Finish]	-	\$186.00	\$196.00	\$178.00	\$249.00
8827-F Flush Transom Latch Cover Kit	050481	.[Finish]	-	\$259.00	\$272.00	\$259.00	\$292.00
8827 Latch Special Chassis Nut	050277	-	\$19.00	-	-	-	-
8847-F Release Guide Cover w/Screws	050278	.[Finish]	-	\$289.00	\$289.00	\$289.00	\$392.00
8827 LR Top Rod Connector	050279	-	\$24.00	-	-	-	-

PARTS AND ACCESSORIES

605	606	611	612	613	619	622	625	626	626AM	628	629
US3	US4	US9	US10	US10B	US15	US19	US26	US26D	US26DAM	US28	US32
630	630AM	643e	689	691	693	695	706	710	711	721	728
US32D	US32DAM	-	SP28	SPIO	SPBLK	SP313	SP4	313	315	US3A	US4A

VERTICAL LATCHES

Description	Specify		Non-finished	613, 626	612	606	605, 619, 622, 625, 693
	Part number	Finish					
8827 LR Bottom Rod Connector	050327	-	\$24.00	-	-	-	-
8827 Chassis Tie Rod	050328	-	\$19.00	-	-	-	-
8827-F Special Chassis Hex Stud	050478	-	\$19.00	-	-	-	-
8827-F Plunger Release Bracket	107765	.[Finish]	-	\$103.00	\$103.00	\$90.00	\$103.00
8827 Latch Case Mounting Package	900501	-	\$17.00	-	-	-	-
8827/47-F Soffit Latch Mounting Package	900502	-	\$17.00	-	-	-	-
8847-F Plunger Release Bracket Package	900576	.[Finish]	-	\$118.00	\$118.00	\$118.00	\$118.00
8847-F Flush Transom Release Brkt Pkg	900614	.[Finish]	-	\$173.00	\$173.00	\$173.00	\$173.00
8827 Latch Case Cover Screw Package	900850	.[Finish]	-	\$19.00	\$19.00	\$19.00	\$19.00
8827-F Flush Transom Latch Screw Pkg	900852	.[Finish]	-	\$45.00	\$45.00	\$45.00	\$45.00

VERTICAL RODS

Description	Specify		Non-finished	626	613	612	606	605, 619, 622, 625, 693
	Part number	Finish						
8827 Top Rod Kit	050453	.[Finish]	-	\$153.00	\$153.00	\$180.00	\$153.00	\$198.00
8827-F Top Rod Kit	050454	.[Finish]	-	\$153.00	\$153.00	\$180.00	\$153.00	\$198.00
8827 Bottom Rod Kit	050455	.[Finish]	-	\$153.00	\$153.00	\$180.00	\$153.00	\$198.00
8827-F Bottom Rod Kit	050456	.[Finish]	-	\$153.00	\$153.00	\$180.00	\$153.00	\$198.00
8847-F Top Rod Kit - 6'8"-8' Door	050457	.[Finish]	-	\$563.00	\$563.00	\$563.00	\$563.00	\$563.00
8847-F Bottom Rod Kit	050458	-	\$563.00	-	-	-	-	-
8827 One Piece Top Rod - 8'	050662	.[Finish]	-	\$192.00	\$275.00	\$297.00	\$239.00	\$593.00
8827-F One Piece Top Rod - 8'	050663	.[Finish]	-	\$192.00	\$275.00	\$297.00	\$239.00	\$593.00
8827 12" Extension Rod Kit	051701	.[Finish]	-	\$42.00	\$42.00	\$42.00	\$42.00	\$42.00
8827 24" Extension Rod Kit	051703	.[Finish]	-	\$42.00	\$42.00	\$42.00	\$42.00	\$42.00
8827 36" Extension Rod Kit	050660	.[Finish]	-	\$128.00	\$196.00	\$142.00	\$124.00	\$438.00
8827 48" Extension Rod Kit	050661	.[Finish]	-	\$149.00	\$216.00	\$173.00	\$142.00	\$459.00
8847-F Extension Rod Kit - 8'-10' Door	051705	-	\$42.00	-	-	-	-	-
8847-F Extension Rod Kit - 10'-12' Door	050634	-	\$286.00	-	-	-	-	-
8847-F Extension Rod Kit - 12'-14' Door	050635	-	\$286.00	-	-	-	-	-
8847-F Extension Rod Kit - 14'-16' Door	050636	-	\$286.00	-	-	-	-	-
8827 Extension Rod Coupling	050093	-	\$24.00	-	-	-	-	-
8827 Rod Guide Kit	050482	.[Finish]	-	\$112.00	\$112.00	\$115.00	\$109.00	\$115.00
8827/27-F Bottom Rod Roll Pin Pkg/10	090010	-	\$20.00	-	-	-	-	-
8847/47-F Rod Connector Rivet Pkg/10	090011	-	\$17.00	-	-	-	-	-
8847-F Rod Guide Mtg. Screws Pkg/10	090018	-	\$17.00	-	-	-	-	-
8847-F Bottom Guide Package	100741	-	\$122.00	-	-	-	-	-
8847-F Rod Guide Kit	105140	-	\$33.00	-	-	-	-	-
8827 Rod Guide Mounting Package	900534	.[Finish]	-	\$19.00	\$19.00	\$30.00	\$19.00	\$30.00
8847-F Rod Set Mounting Package	900541	-	\$17.00	-	-	-	-	-
8827 PL Top Rod Connector	967341	-	\$20.00	-	-	-	-	-

98/99 SERIES

605	606	611	612	613	619	622	625	626	626AM	628	629
US3	US4	US9	US10	US10B	US15	US19	US26	US26D	US26DAM	US28	US32
630	630AM	643e	689	691	693	695	706	710	711	721	728
US32D	US32DAM	-	SP28	SP10	SPBLK	SP313	SP4	313	315	US3A	US4A

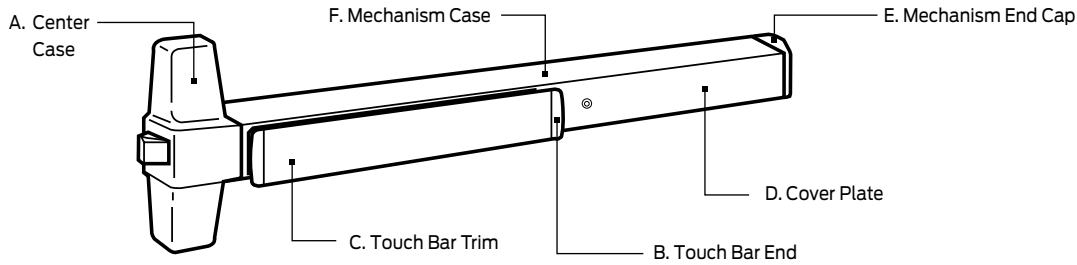

STANDARD FINISHES					
COLOR	US NUMBER	BHMA NUMBER	A, B, E	C - TOUCH BAR TRIM FINISHES	D, F
Bright Brass	US3	605	Bright Brass	Bright Brass, 605 (US3)	Buffed Anodized
Satin Brass	US4	606	Satin Brass	Satin Brass, 606 (US4)	Anodized
Satin Bronze	US10	612	Plated/Anodized	Satin Bronze, 725 (US10)	Anodized
Satin Bronze, Oil-Rubbed	US10B	613	Oil-Rubbed	Oil-Rubbed, 613 (US10B)	Powder Coat
Satin Nickel	US15	619	Plated, Clear Powder Coat	Satin Stainless Steel, 630 (US32D)	Anodized
Polished Chrome	US26	625	Plated	Bright Stainless Steel, 629 (US32)	Buffed Anodized
Satin Chrome	US26D	626	Plated	Satin Stainless Steel, 630 (US32D)	Anodized
Anodized Aluminum	US28	628	Powder Coat	Satin Stainless Steel, 630 (US32D)	Anodized
Satin Stainless Steel	US32D	630	Stainless Steel	Satin Stainless Steel, 630 (US32D)	Anodized
Duranodic Dark Bronze	313	710	Powder Coat	Powder Coat, 710 (313)	Powder Coat
Black	315	711	Powder Coat	Powder Coat, 711 (315)	Powder Coat
Aged Bronze, 643e	--	--	(A) Aged Bronze, No Relief (B, E) Relieved Aged Bronze	Relieved Aged Bronze	Aged Bronze, No Relief

SPECIAL FINISHES					
COLOR	US NUMBER	BHMA NUMBER	A, B, E	C - TOUCH BAR TRIM FINISHES	D, F
Bright Bronze	US9	611	Plated	Bright Bronze US9, 611	Buffed Anodized
Satin Chrome, Antimicrobial	US26D-AM	626-AM	AM Clear over Chrome	AM Clear over Satin Stainless Steel US32D, 630	AM Clear over Anodized
Satin Stainless Steel, Antimicrobial	US32D-AM	630-AM	AM Clear over Stainless Steel	AM Clear over Satin Stainless Steel US32D, 630	AM Clear over Anodized
Powder Coat	RAL # *	--	Powder Coat	Powder Coat	Powder Coat

* See Finish page for optional RAL color information.

FINISH NOTES: 619 and 630 finishes available on Series 98 only. Devices ordered in 628 and 630 will be supplied with Trims in 626.

98/99 SERIES SEX BOLT QUANTITIES				
APPLICATION	SEX BOLT 325 (SUPPLIED)	425 SEX BOLT (SUPPLIED)	425 SEX BOLT (OPTIONAL)	825 SEX BOLT (SUPPLIED)
DT, EO, NL, TP, K or L Device with trim			2	
99 NLOP Device with 110MD/WD			6	
9927 NLOP Device with 110MD/WD			6	
99 EO Device (exit device only)			6	
9927 EO Device (exit device only)			6	
9947 EO Device (exit device only)			6	
99-F Wood Door with trim				2
Windstorm Device	12	6		

98/99 SERIES

605	606	611	612	613	619	622	625	626	626AM	628	629
US3	US4	US9	US10	US10B	US15	US19	US26	US26D	US26DAM	US28	US32
630	630AM	643e	689	691	693	695	706	710	711	721	728
US32D	US32DAM	-	SP28	SP10	SPBLK	SP313	SP4	313	315	US3A	US4A

TYPE OF DEVICE: 98 (SMOOTH) 99 (GROOVED)			
98 or 99 Rim	X98 or X99 Rim	9827 or 9927 Surface Vertical Rod	9857 or 9957 Surface Three Point Latch
9875 or 9975 Mortise Lock	9847 or 9947 / 9848 or 9948 Concealed Vertical Rod	9847 WDC or 9947 WDC Wood Door Concealed Vertical Rod	9849 or 9949 Concealed Vertical Cable
9850 WDC or 9950 WDC Wood Door Concealed Vertical Cable	9852 or 9952 Rim with Remote Trim Input		

FUNCTION			
DT: Dummy Trim	EO: Exit Only	HL: Hospital Latch	K: Knob
KBE: Knob Blank Escutcheon	KDT: Knob Dummy	KNL: Knob Night Latch	L: Lever, O6 Standard
LBE: Lever-Blank Escutcheon	LDT: Lever, Dummy Trim	LNL: Lever-Night Latch	LKC: Lever, Key Capture
NL: Night Latch, Key Retracts	NLOP: Night Latch, Opt. Pull	TL: Turn Lever	TLBE: Turn Lever, Blank Escutcheon
TLOP: Turn Lever, Opt. Pull	TP: Thumbpiece	TPBE: Thumbpiece - Blank Escutcheon	

RATING	
None: Panic Exit Device	- F: Fire Exit Device



DOUBLE CYLINDER	
-2: Double Cylinder	-2S1: Cylinder Dogging with Security Indicator

DEVICE FINISH			
605: Bright Brass (US3)	606: Satin Brass (US4)	612: Satin Bronze (US10)	613: Satin Bronze-Oil Rubbed (US10B)
625: Bright Chrome (US26)	626: Satin Chrome (US26D)	626AM: Antimicrobial (US26D-AM)	628: Anodized Aluminum (US28)
643e: Aged Bronze	710: Duranodic Dark Bronze (313)	711: Black (315)	
Note: 619: Satin Nickel (US15) 98 Series only.			

DEVICE LENGTH (FEET AND INCHES)		
2': 2' Device for 2' Door - Vertical Device only	3': 3' Device for 2' 4" - 3' Door	4': 4' Device for 2' 10" - 4' Door

DEVICE HANDING	
RHR (Right Hand Reverse)	LHR (Left Hand Reverse)

TRIM / CONTROL OPTIONS			
LC Less Control	LT: Less Trim	110MD / 110WD: Standard on NL-OP	374T: Thumbturn Control - SV
376T: Thumbturn Control - CV	376T WDC: 376T for Wood Door	392-7: Optional Pull Dummy Trim	696 / 696WDF: Optional Lever Trim
697 / 697WDF: Optional Lever Trim	VR910: Vandal Resistant	990: Standard Rim	996: Standard. Lever Trim
RX996: Request to Exit 996	M996: Motorized 996	QM996: Quiet Mechanical Trim	

CONTROL LEVER STYLES 06 LEVER STANDARD											
Standard levers:	01	02	03	05	06	07	12	16	17	18	
	ACC: Accent 	AST: Asti 	MER: Merano 	LAT: Latitude	LON: Longitude						
Knurled levers:	03K	06K	M81K								

 Indicates products that have EPD documentation available and meet LEED v4.

Z2 SERIES
33A/35A SERIES
55 SERIES
88 SERIES
98/99 SERIES
XP98/XP99 SERIES
94/95 SERIES
GUARD-X SERIES
ACCESSORIES / PARTS
ELECTRICAL / PARTS

98/99 SERIES

605	606	611	612	613	619	622	625	626	626AM	628	629
US3	US4	US9	US10	US10B	US15	US19	US26	US26D	US26DAM	US28	US32
630	630AM	643e	689	691	693	695	706	710	711	721	728
US32D	US32DAM	-	SP28	SP10	SPBLK	SP313	SP4	313	315	US3A	US4A

CONTROL LEVER STYLES 06 LEVER STANDARD

M Collection lever:	M51	M52	M53	M54	M55	M56	M61	M63
	M81	M82	M83	M84	M85	ME1	ME2	ME3
Stainless steel levers:	03SS	06SS	17SS	LATSS	LONSS	M57	M62	

TRIM / CONTROL / MORTISE FINISH

605: Bright Brass (US3)	606: Satin Brass (US4)	612: Satin Bronze (US10)	613: Satin Bronze-Oil Rubbed (US10B)
625: Bright Chrome (US26)	626: Satin Chrome (US26D)	693: Painted Black (SPBLK)	710: Duranodic Dark Bronze (313)
619: Satin Nickel (US15)	622: Matte Black (US19)	626AM: Antimicrobial (US26D-AM)	629: Bright Stainless (US32)
630: Satin Stainless (US32D)			

MORTISE LOCK

LL: Less Lock	7500: Standard Mortise	SS7500: Signal Switch	7500-2: Double Cylinder
E7500: Electric Unlocking			

RODS FOR SURFACE / CONCEALED VERTICAL DEVICES ONLY

OPR: One Piece Top Rod	LBL: Less Bottom Cable	LBLAFL: LBL with Auxiliary Fire Pin	LBR: Less Bottom Rod
LBRAFL: LBR with Auxiliary Fire Pin			

DOGGING OPTIONS

CD: Cylinder Dogging, Panic Only	CDSI: Cylinder Dogging with Indicator	CI: Cylinder Dogging Indicator	DI: Dogging Indicator
HD: Hex Dogging	HDSI: Hex Dogging with Indicator	LD: Less Dogging	SD: Special Dogging

SWITCH OPTIONS

LX: Latch Bolt Monitoring	LXLC: LBM Low Current	LXR: LBM Request to Exit	LXRLC: LBM Request to Exit Low Current
RX: Request to Exit	RX2: Request to Exit Double Switch	RXLC: Request to Exit Low Current	SS: Signal Switch, Rim or Mortise
WPRX: Waterproof Request to Exit			

LATCH RETRACTION OPTIONS

E: Electric Mortise Lock	EL: Electric Latch Retraction	HD-QEL: Quiet electric latch retraction with hex dogging (panic only)	HD-QELX: Quiet electric latch retraction with hex dogging (panic only) for AX devices
QEL: Quiet Electric Latch Retraction	QELX: Quiet electric latch retraction for AX devices	QEL-L - Quiet electric latch retraction - latchbolt only	PN: Pneumatic Latch Retraction

EMERGENCY SECURE LOCKDOWN

ESL: Emergency Secure Lockdown

QUIET MECHANICAL - CONTROLS MOTION TO REDUCE OPERATIONAL NOISE

QM98/99 Rim	QM98/9927 Surface Vertical Rod	QM996 Trim
-------------	--------------------------------	------------

98/99 SERIES

605	606	611	612	613	619	622	625	626	626AM	628	629
US3	US4	US9	US10	US10B	US15	US19	US26	US26D	US26DAM	US28	US32
630	630AM	643e	689	691	693	695	706	710	711	721	728
US32D	US32DAM	-	SP28	SP10	SPBLK	SP313	SP4	313	315	US3A	US4A

CX DELAYED EGRESS

CX: Chexit - Controlled Exit	CXRCM: Remote Chexit Module
------------------------------	-----------------------------

ELECTRICAL LOCKING

ES: Pullman Latch for Electric Strike	FS: Fail Safe	FSE: Fail Secure
---------------------------------------	---------------	------------------

STORM RATING

HH: Wind and Impact - Hurricane Rated	HW: Wind Only - Hurricane Rated	HHCX: Wind and Impact - Hurricane Rated - CX	HHCXR: Wind and Impact - Hurricane Rated - CX - RCM
WS: Windstorm			

ACCESSIBLE DEVICE

AX: Accessible device compliant with the California Building Code (Section 11B-309.4) requirement for 5 lb. maximum operational force.
--

STRIKE SERIES

LS: Less Strike	LTS: Less Top Strike	1410: Optional Rim	1606: Optional Rim
1609: Optional Rim	249: Standard CVC	260U: Optional SV Flush Transom	260UF: Option SV Fire Flush Transom
264: Optional Rim or SV	283: Optional CV - Wood Frame	299: Optional Rim	299F: Standard SV Fire
338: Standard CV	499F: Standard SV Fire LBR	575 / 575-2: Standard Mortise	576A: Mortise, pairs 1-3/4 Dr
576B: Mortise, pairs 2-1/4 Dr			

BOTTOM STRIKE SERIES

LBS: Less Bottom Strike	248L4: Surface	304L: Mortise	349: Standard CVC
385A: Adjustable Mortise			

STRIKE FINISH

605: Bright Brass (US3)	606: Satin Brass (US4)	612: Satin Bronze (US10)	613: Satin Bronze-Oil Rubbed (US10B)
622: Matte Black (US19)	625: Bright Chrome(US26)	626: Satin Chrome (US26D)	629: Bright Stainless (US32)
630: Satin Stainless (US32D)	691: Painted Light Bronze (SP10)	695: Painted Dark Bronze (SP313)	MD: e-Moly

TOUCH BAR TRIM OPTIONS

BR: Braille	EMB: Embossed "Push"	KN: Knurled	RSS: Emergency Exit (630 only)
SG: Safety Glow			

DRAINAGE / WEEP HOLES

WH: Drainage/Weep Holes in Mechanism Case (3' device will have 5 holes, 6" spacing; 4' device will have 7 holes, 6" spacing)
--

CX DELAYED EGRESS RELEASE DELAY

0SEC: 0 second delay	15SEC: 15 second delay	INFDEL: Infinite delay	30SEC: 30 second delay
M15SEC: 15 second mute delay	BOCA15SEC: BOCA 15 second delay	LRG (Less Rod Guards)	RGO (Rod Guards Only)

98/99 SERIES

605	606	611	612	613	619	622	625	626	626AM	628	629
US3	US4	US9	US10	US10B	US15	US19	US26	US26D	US26DAM	US28	US32
630	630AM	643e	689	691	693	695	706	710	711	721	728
US32D	US32DAM	-	SP28	SP10	SPBLK	SP313	SP4	313	315	US3A	US4A

MISC DEVICE OPTIONS

CE: CE Label	10WDA: WDA cover plate	ALK: Standard Alarm Kit	RAT REL: Ratchet Release Assy
LCP: Less cover plate	PL: Include Pullman Latch	CYL: Include Cylinder	SNB: Include # of Sex Bolts

CONNECTOR

CON: Connectors

SLM BLOCKING

SLM: SLM Blocking

SECURITY SCREWS

SEC: Include Security Screws

GBK/SHIM KIT/RISES

GBK: Include GBK

DOOR MATERIAL

ALD: Aluminum door	CP: Composite door	HMD: Hollow metal	WD: Wood door
INS2: Insulclad - 1/2"	INS4: Insulclad - 1/4"	SC: Steelcraft (HH Device Only)	

DOOR THICKNESS

DT1-3/4: 1-3/4" Standard	DT2: 2" thickness	DT2-1/4: 2-1/4" thickness
--------------------------	-------------------	---------------------------

DOOR MODE/APPLICATION

DE: Pair Double egress doors	PR: Pair of doors	SGL: Single door
------------------------------	-------------------	------------------

APPLICATION NOTE FOR 2' DEVICE

Available on Surface and Concealed Vertical (panic and fire).

When vertical rod devices are used on both doors of a pair, operation of the inactive door (smaller door) will not disengage the active door, creating a potential safety issue for those using the inactive door during an emergency. In addition, standard hex or cylinder dogging is not available. If dogging is required, special center case dogging is available for 98/9927/47/49/50WDC devices. Prefix device with "SD".

For pairs of doors using one 2' door Von Duprin recommends the following hardware combinations listed below for optimum safety in an emergency.

1. Surface or Concealed Vertical device on the 2' door (inactive) and a mortise device on the larger door (active). This combination is used primarily on Hollow Metal door applications only.
2. Automatic Flush Bolt on the 2' door (inactive) and a Surface or Concealed Vertical device on the larger door (active).

Note: The 2' door width is not available with any electrical, Chexit, hurricane or windstorm options.

98/99 SERIES

605	606	611	612	613	619	622	625	626	626AM	628	629
US3	US4	US9	US10	US10B	US15	US19	US26	US26D	US26DAM	US28	US32
630	630AM	643e	689	691	693	695	706	710	711	721	728
US32D	US32DAM	-	SP28	SPIO	SPBLK	SP313	SP4	313	315	US3A	US4A

Rim devices

ACN							PRICE BASED ON FINISH						Default trim, included			
Device type	Function	Fire	Finish	Device size	Handing	Lever design	626	628	630 ^{1,3}	710	612	606 ²		643E	711	613 ²
EXIT HARDWARE							3' DEVICE PRICING SHOWN. 4' ADD \$26.00 LIST									
[98/99]	EO	.	[]	[]	.		\$1,986	\$1,789	\$2,043	\$1,899	\$2,043	\$2,111	\$2,356	\$2,902	\$2,367	N/A
[98/99]	DT	.	[]	[]	.		\$2,348	\$2,151	\$2,405	\$2,277	\$2,421	\$2,402	\$2,750	\$3,280	\$2,745	990DT
[98/99]	NL	.	[]	[]	[]		\$2,369	\$2,172	\$2,426	\$2,298	\$2,442	\$2,423	\$2,771	\$3,301	\$2,766	990NL-R/V
[98/99]	NL-OP	.	[]	[]	.		\$2,174	\$1,977	\$2,231	\$2,087	\$2,231	\$2,284	\$2,544	\$3,090	\$2,555	110MD/WD
[98/99]	TP	.	[]	[]	.		\$2,504	\$2,307	\$2,561	\$2,431	\$2,561	\$2,542	\$2,913	\$3,434	\$2,899	990TP-R/V
[98/99]	TP-BE	.	[]	[]	.		\$2,504	\$2,307	\$2,561	\$2,431	\$2,561	\$2,542	\$2,913	\$3,434	\$2,899	990TP-BE-R/V
[98/99]	K	.	[]	[]	.		\$2,622	\$2,425	\$2,679	\$2,535	\$2,764	\$2,646	\$3,125	\$3,538	\$3,003	996K-R/V
[98/99]	K-BE	.	[]	[]	.		\$2,622	\$2,425	\$2,679	\$2,535	\$2,764	\$2,646	\$3,125	\$3,538	\$3,003	996K-BE-R/V
[98/99]	K-DT	.	[]	[]	.		\$2,608	\$2,411	\$2,665	\$2,521	\$2,750	\$2,632	\$3,111	\$3,524	\$2,989	996K-DT-R/V
[98/99]	K-NL	.	[]	[]	.		\$2,608	\$2,411	\$2,665	\$2,521	\$2,750	\$2,632	\$3,111	\$3,524	\$2,989	996K-NL-R/V
[98/99]	L	.	[]	[]	[]	[]	\$2,814	\$2,617	\$2,871	\$2,727	\$2,944	\$2,897	\$3,293	\$3,730	\$3,225	996L-R/V
[98/99]	L-BE	.	[]	[]	[]	[]	\$2,814	\$2,617	\$2,871	\$2,727	\$2,944	\$2,897	\$3,293	\$3,730	\$3,225	996L-BE-R/V
[98/99]	L-DT	.	[]	[]	[]	[]	\$2,646	\$2,449	\$2,703	\$2,559	\$2,776	\$2,729	\$3,125	\$3,562	\$3,057	996L-DT-R/V
[98/99]	L-NL	.	[]	[]	[]	[]	\$2,646	\$2,449	\$2,703	\$2,559	\$2,776	\$2,729	\$3,125	\$3,562	\$3,057	996L-NL-R/V
[98/99]	L-KC	.	[]	[]	[]	[]	\$2,814	\$2,617	\$2,871	\$2,727	\$2,944	\$2,897	\$3,293	\$3,730	\$3,225	996L-KC-R/V
FIRE EXIT HARDWARE							3' DEVICE PRICING SHOWN. 4' ADD \$26.00 LIST									
[98/99]	EO	.	F	[]	[]		\$2,274	\$2,077	\$2,331	\$2,187	\$2,331	\$2,399	\$2,644	\$3,190	\$2,655	N/A
[98/99]	DT	.	F	[]	[]		\$2,636	\$2,439	\$2,693	\$2,565	\$2,709	\$2,690	\$3,038	\$3,568	\$3,033	990DT
[98/99]	NL	.	F	[]	[]	[]	\$2,657	\$2,460	\$2,714	\$2,586	\$2,730	\$2,711	\$3,059	\$3,589	\$3,054	990NL-R/V
[98/99]	NL-OP	.	F	[]	[]		\$2,462	\$2,265	\$2,519	\$2,375	\$2,519	\$2,572	\$2,832	\$3,378	\$2,843	110MD/WD
[98/99]	TP	.	F	[]	[]		\$2,792	\$2,595	\$2,849	\$2,719	\$2,849	\$2,830	\$3,201	\$3,722	\$3,187	990TP-R/V
[98/99]	TP-BE	.	F	[]	[]		\$2,792	\$2,595	\$2,849	\$2,719	\$2,849	\$2,830	\$3,201	\$3,722	\$3,187	990TP-BE-R/V
[98/99]	K	.	F	[]	[]		\$2,910	\$2,713	\$2,967	\$2,823	\$3,052	\$2,934	\$3,413	\$3,826	\$3,291	996K-R/V
[98/99]	K-BE	.	F	[]	[]		\$2,910	\$2,713	\$2,967	\$2,823	\$3,052	\$2,934	\$3,413	\$3,826	\$3,291	996K-BE-R/V
[98/99]	K-NL	.	F	[]	[]		\$2,896	\$2,699	\$2,953	\$2,809	\$3,038	\$2,920	\$3,399	\$3,812	\$3,277	996K-NL-R/V
[98/99]	L	.	F	[]	[]	[]	\$3,102	\$2,905	\$3,159	\$3,015	\$3,232	\$3,185	\$3,581	\$4,018	\$3,513	996L-R/V
[98/99]	L-BE	.	F	[]	[]	[]	\$3,102	\$2,905	\$3,159	\$3,015	\$3,232	\$3,185	\$3,581	\$4,018	\$3,513	996L-BE-R/V
[98/99]	L-NL	.	F	[]	[]	[]	\$2,934	\$2,737	\$2,991	\$2,847	\$3,064	\$3,017	\$3,413	\$3,850	\$3,345	996L-NL-R/V
[98/99]	L-KC	.	F	[]	[]	[]	\$3,102	\$2,905	\$3,159	\$3,015	\$3,232	\$3,185	\$3,581	\$4,018	\$3,513	996L-KC-R/V

² Consult factory for lead time.

¹ 630 and 619 finishes available only on 98 Series.

² 613 finish has 710 finish device with 613 parts.

³ 98 device in 630 finish is supplied with 626 trim by default.

DEFAULT ATTRIBUTES

Pricing includes default options shown below. Additional options and configurations available.

Cylinders:	Sex bolts	Door thickness	Center line
Not included	Not included	1-3/4"	39-13/16"

Strike(s):

Exit hardware:

- Includes 299 strike

Fire exit hardware:

- Single door applications: Includes 299F strike
- Double door applications: 499F strike will be supplied at an additional \$150.00 list add

98/99 SERIES

605	606	611	612	613	619	622	625	626	626AM	628	629
US3	US4	US9	US10	US10B	US15	US19	US26	US26D	US26DAM	US28	US32
630	630AM	643e	689	691	693	695	706	710	711	721	728
US32D	US32DAM	-	SP28	SPI0	SPBLK	SP313	SP4	313	315	US3A	US4A

Surface vertical rod devices (27)

ACN							PRICE BASED ON FINISH							Default trim, included							
Device type	Function	Fire	Finish	Device size	Handing	Lever design	626	628	630 ¹	710	612	606 ²	605 ² 619 ² 625 643E		711	613 ³					
							3' DEVICE PRICING SHOWN. 2' ADD \$104.00 LIST, 4' ADD \$26.00 LIST														
EXIT HARDWARE							3' DEVICE PRICING SHOWN. 2' ADD \$104.00 LIST, 4' ADD \$26.00 LIST														
[98/99]27	EO	.	[]	.	[]	.	\$2,891	\$2,576	\$3,088	\$2,818	\$3,002	\$3,121	\$3,335	\$3,805	\$3,559	N/A					
[98/99]27	DT	.	[]	.	[]	.	\$3,253	\$2,938	\$3,450	\$3,196	\$3,380	\$3,412	\$3,729	\$4,183	\$3,937	990DT					
[98/99]27	NL	.	[]	.	[]	[]	\$3,274	\$2,959	\$3,471	\$3,217	\$3,401	\$3,433	\$3,750	\$4,204	\$3,958	990NL-R/V					
[98/99]27	NL-OP	.	[]	.	[]	.	\$3,079	\$2,764	\$3,276	\$3,006	\$3,190	\$3,294	\$3,523	\$3,993	\$3,747	110MD/WD					
[98/99]27	TP	.	[]	.	[]	.	\$3,409	\$3,094	\$3,606	\$3,350	\$3,520	\$3,552	\$3,892	\$4,337	\$4,091	990TP-R/V					
[98/99]27	TP-BE	.	[]	.	[]	.	\$3,409	\$3,094	\$3,606	\$3,350	\$3,520	\$3,552	\$3,892	\$4,337	\$4,091	990TP-BE-R/V					
[98/99]27	K	.	[]	.	[]	.	\$3,527	\$3,212	\$3,724	\$3,454	\$3,723	\$3,656	\$4,104	\$4,441	\$4,195	996K-R/V					
[98/99]27	K-BE	.	[]	.	[]	.	\$3,527	\$3,212	\$3,724	\$3,454	\$3,723	\$3,656	\$4,104	\$4,441	\$4,195	996K-BE-R/V					
[98/99]27	K-DT	.	[]	.	[]	.	\$3,513	\$3,198	\$3,710	\$3,440	\$3,709	\$3,642	\$4,090	\$4,427	\$4,181	996K-DT-R/V					
[98/99]27	K-NL	.	[]	.	[]	.	\$3,513	\$3,198	\$3,710	\$3,440	\$3,709	\$3,642	\$4,090	\$4,427	\$4,181	996K-NL-R/V					
[98/99]27	L	.	[]	.	[]	[]	\$3,719	\$3,404	\$3,916	\$3,646	\$3,903	\$3,907	\$4,272	\$4,633	\$4,417	996L-R/V					
[98/99]27	L-BE	.	[]	.	[]	[]	\$3,719	\$3,404	\$3,916	\$3,646	\$3,903	\$3,907	\$4,272	\$4,633	\$4,417	996L-BE-R/V					
[98/99]27	L-DT	.	[]	.	[]	[]	\$3,551	\$3,236	\$3,748	\$3,478	\$3,735	\$3,739	\$4,104	\$4,465	\$4,249	996L-DT-R/V					
[98/99]27	L-NL	.	[]	.	[]	[]	\$3,551	\$3,236	\$3,748	\$3,478	\$3,735	\$3,739	\$4,104	\$4,465	\$4,249	996L-NL-R/V					
[98/99]27	L-KC	.	[]	.	[]	[]	\$3,719	\$3,404	\$3,916	\$3,646	\$3,903	\$3,907	\$4,272	\$4,633	\$4,417	996L-KC-R/V					
[98/99]27	TL	.	[]	.	[]	.	\$4,299	\$3,984	\$4,496	\$4,242	\$4,506	\$4,313	\$4,855	\$5,229	\$4,983	990DT/374T ⁴					
[98/99]27	TL-BE	.	[]	.	[]	.	\$4,242	\$3,927	\$4,439	\$4,185	\$4,449	\$4,256	\$4,798	\$5,172	\$4,926	990DT/374T-BE ⁴					
FIRE EXIT HARDWARE							3' DEVICE PRICING SHOWN. 2' ADD \$104.00 LIST, 4' ADD \$26.00 LIST														
[98/99]27	EO	.	F	.	[]	[]	\$3,314	\$2,999	\$3,511	\$3,241	\$3,425	\$3,544	\$3,758	\$4,228	\$3,982	N/A					
[98/99]27	DT	.	F	.	[]	[]	\$3,676	\$3,361	\$3,873	\$3,619	\$3,803	\$3,835	\$4,152	\$4,606	\$4,360	990DT					
[98/99]27	NL	.	F	.	[]	[]	\$3,697	\$3,382	\$3,894	\$3,640	\$3,824	\$3,856	\$4,173	\$4,627	\$4,381	990NL-R/V					
[98/99]27	NL-OP	.	F	.	[]	[]	\$3,502	\$3,187	\$3,699	\$3,429	\$3,613	\$3,717	\$3,946	\$4,416	\$4,170	110MD/WD					
[98/99]27	TP	.	F	.	[]	[]	\$3,832	\$3,517	\$4,029	\$3,773	\$3,943	\$3,975	\$4,315	\$4,760	\$4,514	990TP-R/V					
[98/99]27	TP-BE	.	F	.	[]	[]	\$3,832	\$3,517	\$4,029	\$3,773	\$3,943	\$3,975	\$4,315	\$4,760	\$4,514	990TP-BE-R/V					
[98/99]27	K	.	F	.	[]	[]	\$3,950	\$3,635	\$4,147	\$3,877	\$4,146	\$4,079	\$4,527	\$4,864	\$4,618	996K-R/V					
[98/99]27	K-BE	.	F	.	[]	[]	\$3,950	\$3,635	\$4,147	\$3,877	\$4,146	\$4,079	\$4,527	\$4,864	\$4,618	996K-BE-R/V					
[98/99]27	K-NL	.	F	.	[]	[]	\$3,936	\$3,621	\$4,133	\$3,863	\$4,132	\$4,065	\$4,513	\$4,850	\$4,604	996K-NL-R/V					
[98/99]27	L	.	F	.	[]	[]	\$4,142	\$3,827	\$4,339	\$4,069	\$4,326	\$4,330	\$4,695	\$5,056	\$4,840	996L-R/V					
[98/99]27	L-BE	.	F	.	[]	[]	\$4,142	\$3,827	\$4,339	\$4,069	\$4,326	\$4,330	\$4,695	\$5,056	\$4,840	996L-BE-R/V					
[98/99]27	L-NL	.	F	.	[]	[]	\$3,974	\$3,659	\$4,171	\$3,901	\$4,158	\$4,162	\$4,527	\$4,888	\$4,672	996L-NL-R/V					
[98/99]27	L-KC	.	F	.	[]	[]	\$4,142	\$3,827	\$4,339	\$4,069	\$4,326	\$4,330	\$4,695	\$5,056	\$4,840	996L-KC-R/V					
[98/99]27	TL	.	F	.	[]	[]	\$4,722	\$4,407	\$4,919	\$4,665	\$4,929	\$4,736	\$5,278	\$5,652	\$5,406	990DT/374T ⁴					
[98/99]27	TL-BE	.	F	.	[]	[]	\$4,665	\$4,350	\$4,862	\$4,608	\$4,872	\$4,679	\$5,221	\$5,595	\$5,349	990DT/374T-BE ⁴					

⊗ Consult factory for lead time.

- ¹ 98 device in 630 finish is supplied with 626 trim by default.
- ² 630 and 619 finishes available only on 98 Series.
- ³ 613 finish has 710 finish device with 613 parts.
- ⁴ Wood doors - 10WDA cover plate is required for the 370 series controls and will be supplied at an additional, \$75.00 list add.

DEFAULT ATTRIBUTES

Pricing includes default options shown below. Additional options and configurations available.

Cylinders:	Sex bolts	Door thickness	Center line
Not included	Not included	1-3/4"	39-13/16"

Strike(s):	Exit hardware:	Fire exit hardware:
	Includes 299, 248L-4, 304L strikes and sex bolts for latches	Includes 299F, 304L strikes and sex bolts for latches

98/99 SERIES

605	606	611	612	613	619	622	625	626	626AM	628	629
US3	US4	US9	US10	US10B	US15	US19	US26	US26D	US26DAM	US28	US32
630	630AM	643e	689	691	693	695	706	710	711	721	728
US32D	US32DAM	-	SP28	SPIO	SPBLK	SP313	SP4	313	315	US3A	US4A

Concealed vertical rod devices (47)

ACN							PRICE BASED ON FINISH							Default trim, included		
Device type	Function	Fire	Finish	Device size	Handing	Lever design	605 [Ⓢ] 619 ² 625 643E									
							626	628	630 ¹	710	612	606 [Ⓢ]	643E		711	613 ³
EXIT HARDWARE							3' DEVICE PRICING SHOWN. 2' ADD \$104.00 LIST, 4' ADD \$26.00 LIST									
[98/99]47 . EO . [] . [] .							\$3,028	\$2,701	\$3,110	\$2,943	\$3,067	\$3,185	\$3,380	\$3,930	\$3,628	N/A
[98/99]47 . DT . [] . [] .							\$3,390	\$3,063	\$3,472	\$3,321	\$3,445	\$3,476	\$3,774	\$4,308	\$4,006	990DT
[98/99]47 . NL . [] . [] . []							\$3,411	\$3,084	\$3,493	\$3,342	\$3,466	\$3,497	\$3,795	\$4,329	\$4,027	990NL-R/V
[98/99]47 . NL-OP . [] . [] .							\$3,216	\$2,889	\$3,298	\$3,131	\$3,255	\$3,358	\$3,568	\$4,118	\$3,816	110MD/WD
[98/99]47 . TP . [] . [] .							\$3,546	\$3,219	\$3,628	\$3,475	\$3,585	\$3,616	\$3,937	\$4,462	\$4,160	990TP-R/V
[98/99]47 . TP-BE . [] . [] .							\$3,546	\$3,219	\$3,628	\$3,475	\$3,585	\$3,616	\$3,937	\$4,462	\$4,160	990TP-BE-R/V
[98/99]47 . K . [] . [] .							\$3,664	\$3,337	\$3,746	\$3,579	\$3,788	\$3,720	\$4,149	\$4,566	\$4,264	996K-R/V
[98/99]47 . K-BE . [] . [] .							\$3,664	\$3,337	\$3,746	\$3,579	\$3,788	\$3,720	\$4,149	\$4,566	\$4,264	996K-BE-R/V
[98/99]47 . K-DT . [] . [] .							\$3,650	\$3,323	\$3,732	\$3,565	\$3,774	\$3,706	\$4,135	\$4,552	\$4,250	996K-DT-R/V
[98/99]47 . K-NL . [] . [] .							\$3,650	\$3,323	\$3,732	\$3,565	\$3,774	\$3,706	\$4,135	\$4,552	\$4,250	996K-NL-R/V
[98/99]47 . L . [] . [] . [] . []							\$3,856	\$3,529	\$3,938	\$3,771	\$3,968	\$3,971	\$4,317	\$4,758	\$4,486	996L-R/V
[98/99]47 . L-BE . [] . [] . [] . []							\$3,856	\$3,529	\$3,938	\$3,771	\$3,968	\$3,971	\$4,317	\$4,758	\$4,486	996L-BE-R/V
[98/99]47 . L-DT . [] . [] . [] . []							\$3,688	\$3,361	\$3,770	\$3,603	\$3,800	\$3,803	\$4,149	\$4,590	\$4,318	996L-DT-R/V
[98/99]47 . L-NL . [] . [] . [] . []							\$3,688	\$3,361	\$3,770	\$3,603	\$3,800	\$3,803	\$4,149	\$4,590	\$4,318	996L-NL-R/V
[98/99]47 . L-KC . [] . [] . [] . []							\$3,856	\$3,529	\$3,938	\$3,771	\$3,968	\$3,971	\$4,317	\$4,758	\$4,486	996L-KC-R/V
[98/99]47 . TL . [] . []							\$4,436	\$4,109	\$4,518	\$4,367	\$4,571	\$4,377	\$4,900	\$5,434	\$5,052	990DT/376T ⁴
[98/99]47 . TL-BE . [] . []							\$4,379	\$4,052	\$4,461	\$4,310	\$4,514	\$4,320	\$4,843	\$5,377	\$4,995	990DT/376T-BE ⁴
FIRE EXIT HARDWARE							3' DEVICE PRICING SHOWN. 2' ADD \$104.00 LIST, 4' ADD \$26.00 LIST									
[98/99]47 . EO . F . [] . []							\$3,497	\$3,170	\$3,579	\$3,412	\$3,536	\$3,654	\$3,849	\$4,399	\$4,097	N/A
[98/99]47 . DT . F . [] . []							\$3,859	\$3,532	\$3,941	\$3,790	\$3,914	\$3,945	\$4,243	\$4,777	\$4,475	990DT
[98/99]47 . NL . F . [] . [] . []							\$3,880	\$3,553	\$3,962	\$3,811	\$3,935	\$3,966	\$4,264	\$4,798	\$4,496	990NL-R/V
[98/99]47 . NL-OP . F . [] . []							\$3,685	\$3,358	\$3,767	\$3,600	\$3,724	\$3,827	\$4,037	\$4,587	\$4,285	110MD/WD
[98/99]47 . TP . F . [] . []							\$4,015	\$3,688	\$4,097	\$3,944	\$4,054	\$4,085	\$4,406	\$4,931	\$4,629	990TP-R/V
[98/99]47 . TP-BE . F . [] . []							\$4,015	\$3,688	\$4,097	\$3,944	\$4,054	\$4,085	\$4,406	\$4,931	\$4,629	990TP-BE-R/V
[98/99]47 . K . F . [] . []							\$4,133	\$3,806	\$4,215	\$4,048	\$4,257	\$4,189	\$4,618	\$5,035	\$4,733	996K-R/V
[98/99]47 . K-BE . F . [] . []							\$4,133	\$3,806	\$4,215	\$4,048	\$4,257	\$4,189	\$4,618	\$5,035	\$4,733	996K-BE-R/V
[98/99]47 . K-NL . F . [] . []							\$4,119	\$3,792	\$4,201	\$4,034	\$4,243	\$4,175	\$4,604	\$5,021	\$4,719	996K-NL-R/V
[98/99]47 . L . F . [] . [] . [] . []							\$4,325	\$3,998	\$4,407	\$4,240	\$4,437	\$4,440	\$4,786	\$5,227	\$4,955	996L-R/V
[98/99]47 . L-BE . F . [] . [] . [] . []							\$4,325	\$3,998	\$4,407	\$4,240	\$4,437	\$4,440	\$4,786	\$5,227	\$4,955	996L-BE-R/V
[98/99]47 . L-NL . F . [] . [] . [] . []							\$4,157	\$3,830	\$4,239	\$4,072	\$4,269	\$4,272	\$4,618	\$5,059	\$4,787	996L-NL-R/V
[98/99]47 . L-KC . F . [] . [] . [] . []							\$4,325	\$3,998	\$4,407	\$4,240	\$4,437	\$4,440	\$4,786	\$5,227	\$4,955	996L-KC-R/V
[98/99]47 . TL . F . [] . []							\$4,905	\$4,578	\$4,987	\$4,836	\$5,040	\$4,846	\$5,369	\$5,903	\$5,521	990DT/376T ⁴
[98/99]47 . TL-BE . F . [] . []							\$4,848	\$4,521	\$4,930	\$4,779	\$4,983	\$4,789	\$5,312	\$5,846	\$5,464	990DT/376T-BE ⁴

[Ⓢ] Consult factory for lead time.

- ¹ 98 device in 630 finish is supplied with 626 trim by default.
- ² 630 and 619 finishes available only on 98 Series.
- ³ 613 finish has 710 finish device with 613 parts.
- ⁴ Wood doors - 10WDA cover plate is required for the 370 series controls and will be supplied at an additional, \$75.00 list add.

DEFAULT ATTRIBUTES

Pricing includes default options shown below. Additional options and configurations available.

Cylinders:	Sex bolts	Door thickness	Center line
Not included	Not included	1-3/4"	39-13/16"

- | | |
|----------------------------------|---------------------------------|
| Strike(s): Exit hardware: | Fire exit hardware: |
| ▪ Includes 338 and 385A strikes | ▪ Includes 338 and 385A strikes |

98/99 SERIES

605	606	611	612	613	619	622	625	626	626AM	628	629
US3	US4	US9	US10	US10B	US15	US19	US26	US26D	US26DAM	US28	US32
630	630AM	643e	689	691	693	695	706	710	711	721	728
US32D	US32DAM	-	SP28	SP10	SPBLK	SP313	SP4	313	315	US3A	US4A

Wood Door Concealed vertical rod devices (47-WDC)

ACN							PRICE BASED ON FINISH							Default trim, included				
Device type	Function	Fire	Finish	Device size	Handling	Lever design	626	628	630 ¹	710	612	606 ²	605 ²		619 ²	625	711	613 ³
							643E	711	613 ³	643E	711	613 ³						
EXIT HARDWARE							3' DEVICE PRICING SHOWN. 2' ADD \$104.00 LIST, 4' ADD \$26.00 LIST											
[98/99]47-WDC .	EO	.	[]	.	[]	.	\$3,377	\$3,050	\$3,459	\$3,327	\$3,451	\$3,569	\$3,852	\$4,314	\$3,919		N/A	
[98/99]47-WDC .	DT	.	[]	.	[]	.	\$3,739	\$3,412	\$3,821	\$3,705	\$3,829	\$3,860	\$4,246	\$4,692	\$4,297		990DT	
[98/99]47-WDC .	NL	.	[]	.	[]	.	\$3,760	\$3,433	\$3,842	\$3,726	\$3,850	\$3,881	\$4,267	\$4,713	\$4,318		990NL-R/V	
[98/99]47-WDC .	NL-OP	.	[]	.	[]	.	\$3,565	\$3,238	\$3,647	\$3,515	\$3,639	\$3,742	\$4,040	\$4,502	\$4,107		110WD	
[98/99]47-WDC .	TP	.	[]	.	[]	.	\$3,895	\$3,568	\$3,977	\$3,859	\$3,969	\$4,000	\$4,409	\$4,846	\$4,451		990TP-R/V	
[98/99]47-WDC .	TP-BE	.	[]	.	[]	.	\$3,895	\$3,568	\$3,977	\$3,859	\$3,969	\$4,000	\$4,409	\$4,846	\$4,451		990TP-BE-R/V	
[98/99]47-WDC .	K	.	[]	.	[]	.	\$4,013	\$3,686	\$4,095	\$3,963	\$4,172	\$4,104	\$4,621	\$4,950	\$4,555		996K-R/V	
[98/99]47-WDC .	K-BE	.	[]	.	[]	.	\$4,013	\$3,686	\$4,095	\$3,963	\$4,172	\$4,104	\$4,621	\$4,950	\$4,555		996K-BE-R/V	
[98/99]47-WDC .	K-DT	.	[]	.	[]	.	\$3,999	\$3,672	\$4,081	\$3,949	\$4,158	\$4,090	\$4,607	\$4,936	\$4,541		996K-DT-R/V	
[98/99]47-WDC .	K-NL	.	[]	.	[]	.	\$3,999	\$3,672	\$4,081	\$3,949	\$4,158	\$4,090	\$4,607	\$4,936	\$4,541		996K-NL-R/V	
[98/99]47-WDC .	L	.	[]	.	[]	.	\$4,205	\$3,878	\$4,287	\$4,155	\$4,352	\$4,355	\$4,789	\$5,142	\$4,777		996L-R/V	
[98/99]47-WDC .	L-BE	.	[]	.	[]	.	\$4,205	\$3,878	\$4,287	\$4,155	\$4,352	\$4,355	\$4,789	\$5,142	\$4,777		996L-BE-R/V	
[98/99]47-WDC .	L-DT	.	[]	.	[]	.	\$4,037	\$3,710	\$4,119	\$3,987	\$4,184	\$4,187	\$4,621	\$4,974	\$4,609		996L-DT-R/V	
[98/99]47-WDC .	L-NL	.	[]	.	[]	.	\$4,037	\$3,710	\$4,119	\$3,987	\$4,184	\$4,187	\$4,621	\$4,974	\$4,609		996L-NL-R/V	
[98/99]47-WDC .	L-KC	.	[]	.	[]	.	\$4,205	\$3,878	\$4,287	\$4,155	\$4,352	\$4,355	\$4,789	\$5,142	\$4,777		996L-KC-R/V	
[98/99]47-WDC .	TL	.	[]	.	[]	.	\$4,860	\$4,533	\$4,942	\$4,826	\$5,030	\$4,836	\$5,447	\$5,813	\$5,418		990DT/ 376WDC-T/ 10WDA ⁴	
[98/99]47-WDC .	TL-BE	.	[]	.	[]	.	\$4,803	\$4,476	\$4,885	\$4,769	\$4,973	\$4,779	\$5,390	\$5,756	\$5,361		990DT/ 376WDC-T-BE/ 10WDA ⁴	

² Consult factory for lead time.

¹ 98 device in 630 finish is supplied with 626 trim by default.

² 630 and 619 finishes available only on 98 Series.

³ 613 finish has 710 finish device with 613 parts.

⁴ Wood doors - the 283 strike or WDF must be specified. Specify door thickness.

DEFAULT ATTRIBUTES

Pricing includes default options shown below. Additional options and configurations available.

Cylinders:	Sex bolts	Door thickness	Center line	Scalp plate
Not included	Included	1-3/4"	39-13/16"	Included

Strike(s):

Exit hardware:

- Includes 338 and 385A strikes

Fire exit hardware:

- Includes 338 and 385A strikes

98/99 SERIES

605	606	611	612	613	619	622	625	626	626AM	628	629
US3	US4	US9	US10	US10B	US15	US19	US26	US26D	US26DAM	US28	US32
630	630AM	643e	689	691	693	695	706	710	711	721	728
US32D	US32DAM	-	SP28	SP10	SPBLK	SP313	SP4	313	315	US3A	US4A

Wood Door Concealed vertical rod devices (47-WDC)

ACN							PRICE BASED ON FINISH						Default trim, included			
Device type	Function	File	Finish	Device size	Handling	Lever design	626	628	630 ¹	710	612	606 ²		643E	711	613 ³
FIRE EXIT HARDWARE							3' DEVICE PRICING SHOWN. 2' ADD \$104.00 LIST, 4' ADD \$26.00 LIST									
[98/99]47-WDC . EO . F . [] . []							\$3,908	\$3,581	\$3,990	\$3,858	\$3,982	\$4,100	\$4,383	\$4,845	\$4,450	N/A
[98/99]47-WDC . DT . F . [] . []							\$4,270	\$3,943	\$4,352	\$4,236	\$4,360	\$4,391	\$4,777	\$5,223	\$4,828	990DT
[98/99]47-WDC . NL . F . [] . [] . []							\$4,291	\$3,964	\$4,373	\$4,257	\$4,381	\$4,412	\$4,798	\$5,244	\$4,849	990NL-R/V
[98/99]47-WDC . NL-OP . F . [] . []							\$4,096	\$3,769	\$4,178	\$4,046	\$4,170	\$4,273	\$4,571	\$5,033	\$4,638	110WD
[98/99]47-WDC . TP . F . [] . []							\$4,426	\$4,099	\$4,508	\$4,390	\$4,500	\$4,531	\$4,940	\$5,377	\$4,982	990TP-R/V
[98/99]47-WDC . TP-BE . F . [] . []							\$4,426	\$4,099	\$4,508	\$4,390	\$4,500	\$4,531	\$4,940	\$5,377	\$4,982	990TP-BE-R/V
[98/99]47-WDC . K . F . [] . []							\$4,544	\$4,217	\$4,626	\$4,494	\$4,703	\$4,635	\$5,152	\$5,481	\$5,086	996K-R/V
[98/99]47-WDC . K-BE . F . [] . []							\$4,544	\$4,217	\$4,626	\$4,494	\$4,703	\$4,635	\$5,152	\$5,481	\$5,086	996K-BE-R/V
[98/99]47-WDC . K-NL . F . [] . []							\$4,530	\$4,203	\$4,612	\$4,480	\$4,689	\$4,621	\$5,138	\$5,467	\$5,072	996K-NL-R/V
[98/99]47-WDC . L . F . [] . [] . [] . []							\$4,736	\$4,409	\$4,818	\$4,686	\$4,883	\$4,886	\$5,320	\$5,673	\$5,308	996L-R/V
[98/99]47-WDC . L-BE . F . [] . [] . [] . []							\$4,736	\$4,409	\$4,818	\$4,686	\$4,883	\$4,886	\$5,320	\$5,673	\$5,308	996L-BE-R/V
[98/99]47-WDC . L-NL . F . [] . [] . [] . []							\$4,568	\$4,241	\$4,650	\$4,518	\$4,715	\$4,718	\$5,152	\$5,505	\$5,140	996L-NL-R/V
[98/99]47-WDC . L-KC . F . [] . [] . [] . []							\$4,736	\$4,409	\$4,818	\$4,686	\$4,883	\$4,886	\$5,320	\$5,673	\$5,308	996L-KC-R/V
[98/99]47-WDC . TL . F . [] . []							\$5,391	\$5,064	\$5,473	\$5,357	\$5,561	\$5,367	\$5,978	\$6,344	\$5,949	990DT/ 376WDC-T/ 10WDA ⁴
[98/99]47-WDC . TL-BE . F . [] . []							\$5,334	\$5,007	\$5,416	\$5,300	\$5,504	\$5,310	\$5,921	\$6,287	\$5,892	990DT/ 376WDC-T-BE/ 10WDA ⁴

☒ Consult factory for lead time.

¹ 98 device in 630 finish is supplied with 626 trim by default.

² 630 and 619 finishes available only on 98 Series.

³ 613 finish has 710 finish device with 613 parts.

⁴ Wood doors - the 283 strike or WDF must be specified. Specify door thickness.

DEFAULT ATTRIBUTES

Pricing includes default options shown below. Additional options and configurations available.

Cylinders:	Sex bolts	Door thickness	Center line	Scalp plate
Not included	Included	1-3/4"	39-13/16"	Included

Strike(s):

Exit hardware:

- Includes 338 and 385A strikes

Fire exit hardware:

- Includes 338 and 385A strikes

605	606	611	612	613	619	622	625	626	626AM	628	629
US3	US4	US9	US10	US10B	US15	US19	US26	US26D	US26DAM	US28	US32
630	630AM	643e	689	691	693	695	706	710	711	721	728
US32D	US32DAM	-	SP28	SPIO	SPBLK	SP313	SP4	313	315	US3A	US4A

98/99 SERIES

Concealed vertical rod devices (48)

ACN							PRICE BASED ON FINISH							Default trim, included		
Device type	Function	Fire	Finish	Device size	Handling	Lever design	626	628	630 ¹	710	612	606 ²	643E		711	613 ³
							605 ²	619 ²	625	643E	711	613 ³				
EXIT HARDWARE							3' DEVICE PRICING SHOWN. 2' ADD \$104.00 LIST, 4' ADD \$26.00 LIST									
[98/99]48 . EO . [] . [] .							\$3,479	\$3,152	\$3,561	\$3,394	\$3,518	\$3,636	\$3,831	\$4,381	\$4,079	N/A
[98/99]48 . DT . [] . [] .							\$3,841	\$3,514	\$3,923	\$3,772	\$3,896	\$3,927	\$4,225	\$4,759	\$4,457	990DT
[98/99]48 . NL . [] . [] . [] .							\$3,862	\$3,535	\$3,944	\$3,793	\$3,917	\$3,948	\$4,246	\$4,780	\$4,478	990NL-R/V
[98/99]48 . NL-OP . [] . [] .							\$3,667	\$3,340	\$3,749	\$3,582	\$3,706	\$3,809	\$4,019	\$4,569	\$4,267	110MD
[98/99]48 . TP . [] . [] .							\$3,997	\$3,670	\$4,079	\$3,926	\$4,036	\$4,067	\$4,388	\$4,913	\$4,611	990TP-R/V
[98/99]48 . TP-BE . [] . [] .							\$3,997	\$3,670	\$4,079	\$3,926	\$4,036	\$4,067	\$4,388	\$4,913	\$4,611	990TP-BE-R/V
[98/99]48 . K . [] . [] .							\$4,115	\$3,788	\$4,197	\$4,030	\$4,239	\$4,171	\$4,600	\$5,017	\$4,715	996K-R/V
[98/99]48 . K-BE . [] . [] .							\$4,115	\$3,788	\$4,197	\$4,030	\$4,239	\$4,171	\$4,600	\$5,017	\$4,715	996K-BE-R/V
[98/99]48 . K-DT . [] . [] .							\$4,101	\$3,774	\$4,183	\$4,016	\$4,225	\$4,157	\$4,586	\$5,003	\$4,701	996K-DT-R/V
[98/99]48 . K-NL . [] . [] .							\$4,101	\$3,774	\$4,183	\$4,016	\$4,225	\$4,157	\$4,586	\$5,003	\$4,701	996K-NL-R/V
[98/99]48 . L . [] . [] . [] . [] .							\$4,307	\$3,980	\$4,389	\$4,222	\$4,419	\$4,422	\$4,768	\$5,209	\$4,937	996L-R/V
[98/99]48 . L-BE . [] . [] . [] . [] .							\$4,307	\$3,980	\$4,389	\$4,222	\$4,419	\$4,422	\$4,768	\$5,209	\$4,937	996L-BE-R/V
[98/99]48 . L-DT . [] . [] . [] . [] .							\$4,139	\$3,812	\$4,221	\$4,054	\$4,251	\$4,254	\$4,600	\$5,041	\$4,769	996L-DT-R/V
[98/99]48 . L-NL . [] . [] . [] . [] .							\$4,139	\$3,812	\$4,221	\$4,054	\$4,251	\$4,254	\$4,600	\$5,041	\$4,769	996L-NL-R/V
[98/99]48 . L-KC . [] . [] . [] . [] .							\$4,307	\$3,980	\$4,389	\$4,222	\$4,419	\$4,422	\$4,768	\$5,209	\$4,937	996L-KC-R/V
[98/99]48 . TL . [] . [] .							\$4,887	\$4,560	\$4,969	\$4,818	\$5,022	\$4,828	\$5,351	\$5,885	\$5,503	990DT/376T
[98/99]48 . TL-BE . [] . [] .							\$4,830	\$4,503	\$4,912	\$4,761	\$4,965	\$4,771	\$5,294	\$5,828	\$5,446	990DT/376T-BE
FIRE EXIT HARDWARE							3' DEVICE PRICING SHOWN. 2' ADD \$104.00 LIST, 4' ADD \$26.00 LIST									
[98/99]48 . EO . F . [] . [] .							\$3,949	\$3,622	\$4,031	\$3,864	\$3,988	\$4,106	\$4,301	\$4,851	\$4,549	N/A
[98/99]48 . DT . F . [] . [] .							\$4,311	\$3,984	\$4,393	\$4,242	\$4,366	\$4,397	\$4,695	\$5,229	\$4,927	990DT
[98/99]48 . NL . F . [] . [] . [] .							\$4,332	\$4,005	\$4,414	\$4,263	\$4,387	\$4,418	\$4,716	\$5,250	\$4,948	990NL-R/V
[98/99]48 . NL-OP . F . [] . [] .							\$4,137	\$3,810	\$4,219	\$4,052	\$4,176	\$4,279	\$4,489	\$5,039	\$4,737	110MD
[98/99]48 . TP . F . [] . [] .							\$4,467	\$4,140	\$4,549	\$4,396	\$4,506	\$4,537	\$4,858	\$5,383	\$5,081	990TP-R/V
[98/99]48 . TP-BE . F . [] . [] .							\$4,467	\$4,140	\$4,549	\$4,396	\$4,506	\$4,537	\$4,858	\$5,383	\$5,081	990TP-BE-R/V
[98/99]48 . K . F . [] . [] .							\$4,585	\$4,258	\$4,667	\$4,500	\$4,709	\$4,641	\$5,070	\$5,487	\$5,185	996K-R/V
[98/99]48 . K-BE . F . [] . [] .							\$4,585	\$4,258	\$4,667	\$4,500	\$4,709	\$4,641	\$5,070	\$5,487	\$5,185	996K-BE-R/V
[98/99]48 . K-NL . F . [] . [] .							\$4,571	\$4,244	\$4,653	\$4,486	\$4,695	\$4,627	\$5,056	\$5,473	\$5,171	996K-NL-R/V
[98/99]48 . L . F . [] . [] . [] . [] .							\$4,777	\$4,450	\$4,859	\$4,692	\$4,889	\$4,892	\$5,238	\$5,679	\$5,407	996L-R/V
[98/99]48 . L-BE . F . [] . [] . [] . [] .							\$4,777	\$4,450	\$4,859	\$4,692	\$4,889	\$4,892	\$5,238	\$5,679	\$5,407	996L-BE-R/V
[98/99]48 . L-NL . F . [] . [] . [] . [] .							\$4,609	\$4,282	\$4,691	\$4,524	\$4,721	\$4,724	\$5,070	\$5,511	\$5,239	996L-NL-R/V
[98/99]48 . L-KC . F . [] . [] . [] . [] .							\$4,777	\$4,450	\$4,859	\$4,692	\$4,889	\$4,892	\$5,238	\$5,679	\$5,407	996L-KC-R/V
[98/99]48 . TL . F . [] . [] .							\$5,357	\$5,030	\$5,439	\$5,288	\$5,492	\$5,298	\$5,821	\$6,355	\$5,973	990DT/376T
[98/99]48 . TL-BE . F . [] . [] .							\$5,300	\$4,973	\$5,382	\$5,231	\$5,435	\$5,241	\$5,764	\$6,298	\$5,916	990DT/376T-BE

² Consult factory for lead time.

¹ 98 device in 630 finish is supplied with 626 trim by default.

² 630 and 619 finishes available only on 98 Series.

³ 613 finish has 710 finish device with 613 parts.

DEFAULT ATTRIBUTES

Pricing includes default options shown below. Additional options and configurations available.

Cylinders:	Sex bolts	Door thickness	Center line
Not included	Not included	1-3/4"	39-13/16"

Strike(s): Exit hardware:
 • Includes 338 and 385A strikes

Fire exit hardware:
 • Includes 338 and 385A strikes

98/99 SERIES

605	606	611	612	613	619	622	625	626	626AM	628	629
US3	US4	US9	US10	US10B	US15	US19	US26	US26D	US26DAM	US28	US32
630	630AM	643e	689	691	693	695	706	710	711	721	728
US32D	US32DAM	-	SP28	SPI0	SPBLK	SP313	SP4	313	315	US3A	US4A

Surface three point latch devices (57)

ACN							PRICE BASED ON FINISH							Default trim, included		
Device type	Function	Fire	Finish	Device size	Handing	Lever design										
							626	628	630 ¹	710	612	606 ²	605 ² 619 ² 625 643E		711	613 ³
EXIT HARDWARE							3' DEVICE PRICING SHOWN. 2' ADD \$104.00 LIST, 4' ADD \$26.00 LIST									
[98/99]57	. EO	. []	. []	. []	. []	. []	\$3,894	\$3,579	\$4,091	\$3,821	\$4,005	\$4,124	\$4,338	\$4,808	\$4,562	N/A
[98/99]57	. DT	. []	. []	. []	. []	. []	\$4,256	\$3,941	\$4,453	\$4,199	\$4,383	\$4,415	\$4,732	\$5,186	\$4,940	990DT
[98/99]57	. NL	. []	. []	. []	. []	. []	\$4,277	\$3,962	\$4,474	\$4,220	\$4,404	\$4,436	\$4,753	\$5,207	\$4,961	990NL-R/V
[98/99]57	. NL-OP	. []	. []	. []	. []	. []	\$4,082	\$3,767	\$4,279	\$4,009	\$4,193	\$4,297	\$4,526	\$4,996	\$4,750	110MD/WD
[98/99]57	. TP	. []	. []	. []	. []	. []	\$4,412	\$4,097	\$4,609	\$4,353	\$4,523	\$4,555	\$4,895	\$5,340	\$5,094	990TP-R/V
[98/99]57	. TP-BE	. []	. []	. []	. []	. []	\$4,412	\$4,097	\$4,609	\$4,353	\$4,523	\$4,555	\$4,895	\$5,340	\$5,094	990TP-BE-R/V
[98/99]57	. K	. []	. []	. []	. []	. []	\$4,530	\$4,215	\$4,727	\$4,457	\$4,726	\$4,659	\$5,107	\$5,444	\$5,198	996K-R/V
[98/99]57	. K-BE	. []	. []	. []	. []	. []	\$4,530	\$4,215	\$4,727	\$4,457	\$4,726	\$4,659	\$5,107	\$5,444	\$5,198	996K-BE-R/V
[98/99]57	. K-DT	. []	. []	. []	. []	. []	\$4,516	\$4,201	\$4,713	\$4,443	\$4,712	\$4,645	\$5,093	\$5,430	\$5,184	996K-DT-R/V
[98/99]57	. K-NL	. []	. []	. []	. []	. []	\$4,516	\$4,201	\$4,713	\$4,443	\$4,712	\$4,645	\$5,093	\$5,430	\$5,184	996K-NL-R/V
[98/99]57	. L	. []	. []	. []	. []	. []	\$4,722	\$4,407	\$4,919	\$4,649	\$4,906	\$4,910	\$5,275	\$5,636	\$5,420	996L-R/V
[98/99]57	. L-BE	. []	. []	. []	. []	. []	\$4,722	\$4,407	\$4,919	\$4,649	\$4,906	\$4,910	\$5,275	\$5,636	\$5,420	996L-BE-R/V
[98/99]57	. L-DT	. []	. []	. []	. []	. []	\$4,554	\$4,239	\$4,751	\$4,481	\$4,738	\$4,742	\$5,107	\$5,468	\$5,252	996L-DT-R/V
[98/99]57	. L-NL	. []	. []	. []	. []	. []	\$4,554	\$4,239	\$4,751	\$4,481	\$4,738	\$4,742	\$5,107	\$5,468	\$5,252	996L-NL-R/V
[98/99]57	. L-KC	. []	. []	. []	. []	. []	\$4,722	\$4,407	\$4,919	\$4,649	\$4,906	\$4,910	\$5,275	\$5,636	\$5,420	996L-KC-R/V
[98/99]57	. TL	. []	. []	. []	. []	. []	\$5,302	\$4,987	\$5,499	\$5,245	\$5,509	\$5,316	\$5,858	\$6,232	\$5,986	990DT/374T ⁴
[98/99]57	. TL-BE	. []	. []	. []	. []	. []	\$5,245	\$4,930	\$5,442	\$5,188	\$5,452	\$5,259	\$5,801	\$6,175	\$5,929	990DT/374T-BE ⁴
FIRE EXIT HARDWARE							3' DEVICE PRICING SHOWN. 2' ADD \$104.00 LIST, 4' ADD \$26.00 LIST									
[98/99]57	. EO	. F	. []	. []	. []	. []	\$4,158	\$3,843	\$4,355	\$4,085	\$4,269	\$4,388	\$4,602	\$5,072	\$4,826	N/A
[98/99]57	. DT	. F	. []	. []	. []	. []	\$4,520	\$4,205	\$4,717	\$4,463	\$4,647	\$4,679	\$4,996	\$5,450	\$5,204	990DT
[98/99]57	. NL	. F	. []	. []	. []	. []	\$4,541	\$4,226	\$4,738	\$4,484	\$4,668	\$4,700	\$5,017	\$5,471	\$5,225	990NL-R/V
[98/99]57	. NL-OP	. F	. []	. []	. []	. []	\$4,346	\$4,031	\$4,543	\$4,273	\$4,457	\$4,561	\$4,790	\$5,260	\$5,014	110MD/WD
[98/99]57	. TP	. F	. []	. []	. []	. []	\$4,676	\$4,361	\$4,873	\$4,617	\$4,787	\$4,819	\$5,159	\$5,604	\$5,358	990TP-R/V
[98/99]57	. TP-BE	. F	. []	. []	. []	. []	\$4,676	\$4,361	\$4,873	\$4,617	\$4,787	\$4,819	\$5,159	\$5,604	\$5,358	990TP-BE-R/V
[98/99]57	. K	. F	. []	. []	. []	. []	\$4,794	\$4,479	\$4,991	\$4,721	\$4,990	\$4,923	\$5,371	\$5,708	\$5,462	996K-R/V
[98/99]57	. K-BE	. F	. []	. []	. []	. []	\$4,794	\$4,479	\$4,991	\$4,721	\$4,990	\$4,923	\$5,371	\$5,708	\$5,462	996K-BE-R/V
[98/99]57	. K-NL	. F	. []	. []	. []	. []	\$4,780	\$4,465	\$4,977	\$4,707	\$4,976	\$4,909	\$5,357	\$5,694	\$5,448	996K-NL-R/V
[98/99]57	. L	. F	. []	. []	. []	. []	\$4,986	\$4,671	\$5,183	\$4,913	\$5,170	\$5,174	\$5,539	\$5,900	\$5,684	996L-R/V
[98/99]57	. L-BE	. F	. []	. []	. []	. []	\$4,986	\$4,671	\$5,183	\$4,913	\$5,170	\$5,174	\$5,539	\$5,900	\$5,684	996L-BE-R/V
[98/99]57	. L-NL	. F	. []	. []	. []	. []	\$4,818	\$4,503	\$5,015	\$4,745	\$5,002	\$5,006	\$5,371	\$5,732	\$5,516	996L-NL-R/V
[98/99]57	. L-KC	. F	. []	. []	. []	. []	\$4,986	\$4,671	\$5,183	\$4,913	\$5,170	\$5,174	\$5,539	\$5,900	\$5,684	996L-KC-R/V
[98/99]57	. TL	. F	. []	. []	. []	. []	\$5,566	\$5,251	\$5,763	\$5,509	\$5,773	\$5,580	\$6,122	\$6,496	\$6,250	990DT/374T ⁴
[98/99]57	. TL-BE	. F	. []	. []	. []	. []	\$5,509	\$5,194	\$5,706	\$5,452	\$5,716	\$5,523	\$6,065	\$6,439	\$6,193	990DT/374T-BE ⁴

² Consult factory for lead time.

¹ 98 device in 630 finish is supplied with 626 trim by default.

² 630 and 619 finishes available only on 98 Series.

³ 613 finish has 710 finish device with 613 parts.

⁴ Wood doors - 10WDA cover plate is required for the 370 series controls and will be supplied at an additional, \$75.00 list add.

DEFAULT ATTRIBUTES

Pricing includes default options shown below. Additional options and configurations available.

Cylinders:	Sex bolts	Door thickness	Center line
Not included	Included for latches	1-3/4"	39-13/16"

Strike(s):

- | | |
|---|--|
| <p>Exit hardware:</p> <ul style="list-style-type: none"> Includes 299(2), 248L-4, 304L strikes and sex bolts for latches | <p>Fire exit hardware:</p> <ul style="list-style-type: none"> Includes 299F(2), 304L strikes and sex bolts for latches For double door applications, the 499F Strike will be supplied for middle strike at an additional \$150.00 list add |
|---|--|

98/99 SERIES

605	606	611	612	613	619	622	625	626	626AM	628	629
US3	US4	US9	US10	US10B	US15	US19	US26	US26D	US26DAM	US28	US32
630	630AM	643e	689	691	693	695	706	710	711	721	728
US32D	US32DAM	-	SP28	SPIO	SPBLK	SP313	SP4	313	315	US3A	US4A

Mortise lock devices (75)

ACN							PRICE BASED ON FINISH							Default trim, included		
Device type	Function	Fire	Finish	Device size	Handing	Lever design	626	628	630 ¹	710	612	606 ²	643E		711	613
EXIT HARDWARE							3' DEVICE PRICING SHOWN. 4' ADD \$26.00 LIST									
[98/99]75 . EO . [] . [] .							\$2,798	\$2,573	\$2,881	\$2,679	\$2,891	\$2,891	\$3,212	\$3,664	\$3,094	N/A
[98/99]75 . HL . [] . [] .							\$3,091	\$2,866	\$3,174	\$2,984	\$3,196	\$3,196	\$3,517	\$3,957	\$3,399	N/A
[98/99]75 . DT . [] . [] .							\$3,160	\$2,935	\$3,243	\$3,057	\$3,269	\$3,182	\$3,606	\$4,042	\$3,472	990DT
[98/99]75 . NL . [] . [] . []							\$3,181	\$2,956	\$3,264	\$3,078	\$3,290	\$3,203	\$3,627	\$4,063	\$3,493	990NL-M
[98/99]75 . TP . [] . [] .							\$3,316	\$3,091	\$3,399	\$3,211	\$3,409	\$3,322	\$3,769	\$4,196	\$3,626	990TP-M
[98/99]75 . TP-BE . [] . [] .							\$3,316	\$3,091	\$3,399	\$3,211	\$3,409	\$3,322	\$3,769	\$4,196	\$3,626	990TP-BE-M
[98/99]75 . K . [] . [] .							\$3,434	\$3,209	\$3,517	\$3,315	\$3,612	\$3,426	\$3,981	\$4,300	\$3,730	996K-M
[98/99]75 . K-BE . [] . [] .							\$3,434	\$3,209	\$3,517	\$3,315	\$3,612	\$3,426	\$3,981	\$4,300	\$3,730	996K-BE-M
[98/99]75 . K-DT . [] . [] .							\$3,420	\$3,195	\$3,503	\$3,301	\$3,598	\$3,412	\$3,967	\$4,286	\$3,716	996K-DT-M
[98/99]75 . K-NL . [] . [] .							\$3,420	\$3,195	\$3,503	\$3,301	\$3,598	\$3,412	\$3,967	\$4,286	\$3,716	996K-NL-M
[98/99]75 . L . [] . [] . [] . []							\$3,626	\$3,401	\$3,709	\$3,507	\$3,792	\$3,677	\$4,149	\$4,492	\$3,952	996L-M
[98/99]75 . L-BE . [] . [] . [] . []							\$3,626	\$3,401	\$3,709	\$3,507	\$3,792	\$3,677	\$4,149	\$4,492	\$3,952	996L-BE-M
[98/99]75 . L-DT . [] . [] . [] . []							\$3,458	\$3,233	\$3,541	\$3,339	\$3,624	\$3,509	\$3,981	\$4,324	\$3,784	996L-DT-M
[98/99]75 . L-NL . [] . [] . [] . []							\$3,458	\$3,233	\$3,541	\$3,339	\$3,624	\$3,509	\$3,981	\$4,324	\$3,784	996L-NL-M
FIRE EXIT HARDWARE							3' DEVICE PRICING SHOWN. 4' ADD \$26.00 LIST									
[98/99]75 . EO . F . [] . []							\$3,102	\$2,877	\$3,185	\$2,983	\$3,195	\$3,195	\$3,516	\$3,968	\$3,398	N/A
[98/99]75 . DT . F . [] . []							\$3,464	\$3,239	\$3,547	\$3,361	\$3,573	\$3,486	\$3,910	\$4,346	\$3,776	990DT
[98/99]75 . HL . F . [] . []							\$3,395	\$3,170	\$3,478	\$3,288	\$3,500	\$3,500	\$3,821	\$4,261	\$3,703	N/A
[98/99]75 . NL . F . [] . [] . []							\$3,485	\$3,260	\$3,568	\$3,382	\$3,594	\$3,507	\$3,931	\$4,367	\$3,797	990NL-M
[98/99]75 . TP . F . [] . []							\$3,620	\$3,395	\$3,703	\$3,515	\$3,713	\$3,626	\$4,073	\$4,500	\$3,930	990TP-M
[98/99]75 . TP-BE . F . [] . []							\$3,620	\$3,395	\$3,703	\$3,515	\$3,713	\$3,626	\$4,073	\$4,500	\$3,930	990TP-BE-M
[98/99]75 . K . F . [] . []							\$3,738	\$3,513	\$3,821	\$3,619	\$3,916	\$3,730	\$4,285	\$4,604	\$4,034	996K-M
[98/99]75 . K-BE . F . [] . []							\$3,738	\$3,513	\$3,821	\$3,619	\$3,916	\$3,730	\$4,285	\$4,604	\$4,034	996K-BE-M
[98/99]75 . K-NL . F . [] . []							\$3,724	\$3,499	\$3,807	\$3,605	\$3,902	\$3,716	\$4,271	\$4,590	\$4,020	996K-NL-M
[98/99]75 . L . F . [] . [] . [] . []							\$3,930	\$3,705	\$4,013	\$3,811	\$4,096	\$3,981	\$4,453	\$4,796	\$4,256	996L-M
[98/99]75 . L-BE . F . [] . [] . [] . []							\$3,930	\$3,705	\$4,013	\$3,811	\$4,096	\$3,981	\$4,453	\$4,796	\$4,256	996L-BE-M
[98/99]75 . L-NL . F . [] . [] . [] . []							\$3,762	\$3,537	\$3,845	\$3,643	\$3,928	\$3,813	\$4,285	\$4,628	\$4,088	996L-NL-M

² Consult factory for lead time.

¹ 98 device in 630 finish is supplied with 626 trim by default.

² 630 and 619 finishes available only on 98 Series.

³ 613 finish has 710 finish device with 613 parts.

DEFAULT ATTRIBUTES

Pricing includes default options shown below. Additional options and configurations available.

Cylinders:	Sex bolts	Door thickness	Center line
Not included	Not included	1-3/4"	39-13/16"

Strike(s):

Exit hardware:

- Includes 575 strike

Fire exit hardware:

- Includes 575 strike

98/99 SERIES

605	606	611	612	613	619	622	625	626	626AM	628	629
US3	US4	US9	US10	US10B	US15	US19	US26	US26D	US26DAM	US28	US32
630	630AM	643e	689	691	693	695	706	710	711	721	728
US32D	US32DAM	-	SP28	SPIO	SPBLK	SP313	SP4	313	315	US3A	US4A

Concealed vertical cable devices (49)

Prices shown are for door opening heights 6'10" - 10'0"

ACN							PRICE BASED ON FINISH							Default trim, included		
Device type	Function	Fire	Finish	Device size	Handling	Lever design	626	628	630 ¹	710	612	606 ²	643E		711	613 ³
EXIT HARDWARE							3' DEVICE PRICING SHOWN. 2' ADD \$104.00 LIST, 4' ADD \$26.00 LIST									
[98/99]49 . EO	.	[]	[]	.			\$3,022	\$2,695	\$3,104	\$2,937	\$3,061	\$3,179	\$3,374	\$3,924	\$3,622	N/A
[98/99]49 . DT	.	[]	[]	.			\$3,384	\$3,057	\$3,466	\$3,315	\$3,439	\$3,470	\$3,768	\$4,302	\$4,000	990DT
[98/99]49 . NL	.	[]	[]	[]	[]		\$3,405	\$3,078	\$3,487	\$3,336	\$3,460	\$3,491	\$3,789	\$4,323	\$4,021	990NL-R/V
[98/99]49 . NL-OP	.	[]	[]	.			\$3,210	\$2,883	\$3,292	\$3,125	\$3,249	\$3,352	\$3,562	\$4,112	\$3,810	110MD
[98/99]49 . TP	.	[]	[]	.			\$3,540	\$3,213	\$3,622	\$3,469	\$3,579	\$3,610	\$3,931	\$4,456	\$4,154	990TP-R/V
[98/99]49 . TP-BE	.	[]	[]	.			\$3,540	\$3,213	\$3,622	\$3,469	\$3,579	\$3,610	\$3,931	\$4,456	\$4,154	990TP-BE-R/V
[98/99]49 . K	.	[]	[]	.			\$3,658	\$3,331	\$3,740	\$3,573	\$3,782	\$3,714	\$4,143	\$4,560	\$4,258	996K-R/V
[98/99]49 . K-BE	.	[]	[]	.			\$3,658	\$3,331	\$3,740	\$3,573	\$3,782	\$3,714	\$4,143	\$4,560	\$4,258	996K-BE-R/V
[98/99]49 . K-DT	.	[]	[]	.			\$3,644	\$3,317	\$3,726	\$3,559	\$3,768	\$3,700	\$4,129	\$4,546	\$4,244	996K-DT-R/V
[98/99]49 . K-NL	.	[]	[]	.			\$3,644	\$3,317	\$3,726	\$3,559	\$3,768	\$3,700	\$4,129	\$4,546	\$4,244	996K-NL-R/V
[98/99]49 . L	.	[]	[]	[]	[]	[]	\$3,850	\$3,523	\$3,932	\$3,765	\$3,962	\$3,965	\$4,311	\$4,752	\$4,480	996L-R/V
[98/99]49 . L-BE	.	[]	[]	[]	[]	[]	\$3,850	\$3,523	\$3,932	\$3,765	\$3,962	\$3,965	\$4,311	\$4,752	\$4,480	996L-BE-R/V
[98/99]49 . L-DT	.	[]	[]	[]	[]	[]	\$3,682	\$3,355	\$3,764	\$3,597	\$3,794	\$3,797	\$4,143	\$4,584	\$4,312	996L-DT-R/V
[98/99]49 . L-NL	.	[]	[]	[]	[]	[]	\$3,682	\$3,355	\$3,764	\$3,597	\$3,794	\$3,797	\$4,143	\$4,584	\$4,312	996L-NL-R/V
[98/99]49 . L-KC	.	[]	[]	[]	[]	[]	\$3,850	\$3,523	\$3,932	\$3,765	\$3,962	\$3,965	\$4,311	\$4,752	\$4,480	996L-KC-R/V
FIRE EXIT HARDWARE							3' DEVICE PRICING SHOWN. 2' ADD \$104.00 LIST, 4' ADD \$26.00 LIST									
[98/99]49 . EO	.	F	[]	[]			\$3,320	\$2,993	\$3,402	\$3,235	\$3,359	\$3,477	\$3,672	\$4,222	\$3,920	N/A
[98/99]49 . DT	.	F	[]	[]			\$3,682	\$3,355	\$3,764	\$3,613	\$3,737	\$3,768	\$4,066	\$4,600	\$4,298	990DT
[98/99]49 . NL	.	F	[]	[]	[]		\$3,703	\$3,376	\$3,785	\$3,634	\$3,758	\$3,789	\$4,087	\$4,621	\$4,319	990NL-R/V
[98/99]49 . NL-OP	.	F	[]	[]			\$3,508	\$3,181	\$3,590	\$3,423	\$3,547	\$3,650	\$3,860	\$4,410	\$4,108	110MD/WD
[98/99]49 . TP	.	F	[]	[]			\$3,838	\$3,511	\$3,920	\$3,767	\$3,877	\$3,908	\$4,229	\$4,754	\$4,452	990TP-R/V
[98/99]49 . TP-BE	.	F	[]	[]			\$3,838	\$3,511	\$3,920	\$3,767	\$3,877	\$3,908	\$4,229	\$4,754	\$4,452	990TP-BE-R/V
[98/99]49 . K	.	F	[]	[]			\$3,956	\$3,629	\$4,038	\$3,871	\$4,080	\$4,012	\$4,441	\$4,858	\$4,556	996K-R/V
[98/99]49 . K-BE	.	F	[]	[]			\$3,956	\$3,629	\$4,038	\$3,871	\$4,080	\$4,012	\$4,441	\$4,858	\$4,556	996K-BE-R/V
[98/99]49 . K-NL	.	F	[]	[]			\$3,942	\$3,615	\$4,024	\$3,857	\$4,066	\$3,998	\$4,427	\$4,844	\$4,542	996K-NL-R/V
[98/99]49 . L	.	F	[]	[]	[]	[]	\$4,148	\$3,821	\$4,230	\$4,063	\$4,260	\$4,263	\$4,609	\$5,050	\$4,778	996L-R/V
[98/99]49 . L-BE	.	F	[]	[]	[]	[]	\$4,148	\$3,821	\$4,230	\$4,063	\$4,260	\$4,263	\$4,609	\$5,050	\$4,778	996L-BE-R/V
[98/99]49 . L-NL	.	F	[]	[]	[]	[]	\$3,980	\$3,653	\$4,062	\$3,895	\$4,092	\$4,095	\$4,441	\$4,882	\$4,610	996L-NL-R/V
[98/99]49 . L-KC	.	F	[]	[]	[]	[]	\$4,148	\$3,821	\$4,230	\$4,063	\$4,260	\$4,263	\$4,609	\$5,050	\$4,778	996L-KC-R/V

For Devices Less Cable System (LCS) Deduct -\$1,385.00

² Consult factory for lead time.

¹ 98 device in 630 finish is supplied with 626 trim by default.

² 630 and 619 finishes available only on 98 Series.

³ 613 finish has 710 finish device with 613 parts.

DEFAULT ATTRIBUTES

Pricing includes default options shown below. Additional options and configurations available.

Cylinders:	Sex bolts	Door thickness	Door opening height
Not included	Not included	1-3/4"	6'10" - 8' is the default door opening height. Specify door opening height if other than 6'10" - 8'. For door opening heights more than 10', consult factory

Strike(s): Exit hardware:
▪ Includes 249 and 349 Strikes

Fire exit hardware:
▪ Includes 249 and 349 Strikes

98/99 SERIES

605	606	611	612	613	619	622	625	626	626AM	628	629
US3	US4	US9	US10	US10B	US15	US19	US26	US26D	US26DAM	US28	US32
630	630AM	643e	689	691	693	695	706	710	711	721	728
US32D	US32DAM	-	SP28	SPIO	SPBLK	SP313	SP4	313	315	US3A	US4A

Wood Door Concealed vertical cable devices (50-WDC)

Prices shown are for door opening heights 6'0" -10'0"

ACN							PRICE BASED ON FINISH										Default trim, Included
Device type	Function	Fire	Finish	Device size	Handing	Lever design											
							626	628	630 ¹	710	612	606 ²	605 ²	619 ²	625	643e	
EXIT HARDWARE							3' DEVICE PRICING SHOWN. 2' ADD \$104.00 LIST, 4' ADD \$26.00 LIST										
[98/99]50-WDC . EO . [] . [] . [] . [] .							\$3,221	\$2,899	\$3,298	\$3,129	\$3,249	\$3,359	\$3,600	\$4,094	\$3,835	N/A	
[98/99]50-WDC . DT . [] . [] . [] . [] .							\$3,583	\$3,261	\$3,660	\$3,507	\$3,627	\$3,650	\$3,994	\$4,472	\$4,213	990DT	
[98/99]50-WDC . NL . [] . [] . [] . [] . [] .							\$3,604	\$3,282	\$3,681	\$3,528	\$3,648	\$3,671	\$4,015	\$4,493	\$4,234	990NL-R/V	
[98/99]50-WDC . NL-OP . [] . [] . [] . [] . [] .							\$3,409	\$3,087	\$3,486	\$3,317	\$3,437	\$3,532	\$3,788	\$4,282	\$4,023	110WD	
[98/99]50-WDC . TP . [] . [] . [] . [] . [] .							\$3,739	\$3,417	\$3,816	\$3,661	\$3,767	\$3,790	\$4,157	\$4,626	\$4,367	990TP-R/V	
[98/99]50-WDC . TP-BE . [] . [] . [] . [] . [] .							\$3,739	\$3,417	\$3,816	\$3,661	\$3,767	\$3,790	\$4,157	\$4,626	\$4,367	990TP-BE-R/V	
[98/99]50-WDC . K . [] . [] . [] . [] . [] .							\$3,857	\$3,535	\$3,934	\$3,765	\$3,970	\$3,894	\$4,369	\$4,730	\$4,471	996K-R/V	
[98/99]50-WDC . K-BE . [] . [] . [] . [] . [] .							\$3,857	\$3,535	\$3,934	\$3,765	\$3,970	\$3,894	\$4,369	\$4,730	\$4,471	996K-BE-R/V	
[98/99]50-WDC . K-DT . [] . [] . [] . [] . [] .							\$3,843	\$3,521	\$3,920	\$3,751	\$3,956	\$3,880	\$4,355	\$4,716	\$4,457	996K-DT-R/V	
[98/99]50-WDC . K-NL . [] . [] . [] . [] . [] .							\$3,843	\$3,521	\$3,920	\$3,751	\$3,956	\$3,880	\$4,355	\$4,716	\$4,457	996K-NL-R/V	
[98/99]50-WDC . L . [] . [] . [] . [] . [] . [] .							\$4,049	\$3,727	\$4,126	\$3,957	\$4,150	\$4,145	\$4,537	\$4,922	\$4,693	996L-R/V	
[98/99]50-WDC . L-BE . [] . [] . [] . [] . [] . [] .							\$4,049	\$3,727	\$4,126	\$3,957	\$4,150	\$4,145	\$4,537	\$4,922	\$4,693	996L-BE-R/V	
[98/99]50-WDC . L-DT . [] . [] . [] . [] . [] . [] .							\$3,881	\$3,559	\$3,958	\$3,789	\$3,982	\$3,977	\$4,369	\$4,754	\$4,525	996L-DT-R/V	
[98/99]50-WDC . L-NL . [] . [] . [] . [] . [] . [] .							\$3,881	\$3,559	\$3,958	\$3,789	\$3,982	\$3,977	\$4,369	\$4,754	\$4,525	996L-NL-R/V	
[98/99]50-WDC . L-KC . [] . [] . [] . [] . [] . [] .							\$4,049	\$3,727	\$4,126	\$3,957	\$4,150	\$4,145	\$4,537	\$4,922	\$4,693	996L-KC-R/V	

For Devices Less Cable System (LCS) Deduct **-\$1,586.00**

FIRE EXIT HARDWARE							3' DEVICE PRICING SHOWN. 2' ADD \$104.00 LIST, 4' ADD \$26.00 LIST									
[98/99]50-WDC . EO . F . [] . [] . [] . [] .							\$3,635	\$3,313	\$3,712	\$3,543	\$3,663	\$3,773	\$4,014	\$4,508	\$4,249	N/A
[98/99]50-WDC . DT . F . [] . [] . [] . [] .							\$3,997	\$3,675	\$4,074	\$3,921	\$4,041	\$4,064	\$4,408	\$4,886	\$4,627	990DT
[98/99]50-WDC . NL . F . [] . [] . [] . [] . [] .							\$4,018	\$3,696	\$4,095	\$3,942	\$4,062	\$4,085	\$4,429	\$4,907	\$4,648	990NL-R/V
[98/99]50-WDC . NL-OP . F . [] . [] . [] . [] . [] .							\$3,823	\$3,501	\$3,900	\$3,731	\$3,851	\$3,946	\$4,202	\$4,696	\$4,437	110WD
[98/99]50-WDC . TP-BE . F . [] . [] . [] . [] . [] .							\$4,153	\$3,831	\$4,230	\$4,075	\$4,181	\$4,204	\$4,571	\$5,040	\$4,781	990TP-BE-R/V
[98/99]50-WDC . TP . F . [] . [] . [] . [] . [] .							\$4,153	\$3,831	\$4,230	\$4,075	\$4,181	\$4,204	\$4,571	\$5,040	\$4,781	990TP-R/V
[98/99]50-WDC . K . F . [] . [] . [] . [] . [] .							\$4,271	\$3,949	\$4,348	\$4,179	\$4,384	\$4,308	\$4,783	\$5,144	\$4,885	996K-R/V
[98/99]50-WDC . K-BE . F . [] . [] . [] . [] . [] .							\$4,271	\$3,949	\$4,348	\$4,179	\$4,384	\$4,308	\$4,783	\$5,144	\$4,885	996K-BE-R/V
[98/99]50-WDC . K-NL . F . [] . [] . [] . [] . [] .							\$4,257	\$3,935	\$4,334	\$4,165	\$4,370	\$4,294	\$4,769	\$5,130	\$4,871	996K-NL-R/V
[98/99]50-WDC . L . F . [] . [] . [] . [] . [] . [] .							\$4,463	\$4,141	\$4,540	\$4,371	\$4,564	\$4,559	\$4,951	\$5,336	\$5,107	996L-R/V
[98/99]50-WDC . L-BE . F . [] . [] . [] . [] . [] . [] .							\$4,463	\$4,141	\$4,540	\$4,371	\$4,564	\$4,559	\$4,951	\$5,336	\$5,107	996L-BE-R/V
[98/99]50-WDC . L-NL . F . [] . [] . [] . [] . [] . [] .							\$4,295	\$3,973	\$4,372	\$4,203	\$4,396	\$4,391	\$4,783	\$5,168	\$4,939	996L-NL-R/V
[98/99]50-WDC . L-KC . F . [] . [] . [] . [] . [] . [] .							\$4,463	\$4,141	\$4,540	\$4,371	\$4,564	\$4,559	\$4,951	\$5,336	\$5,107	996L-KC-R/V

For Devices Less Cable System (LCS) Deduct **-\$2,003.00**

² Consult factory for lead time.

¹ 98 device in 630 finish is supplied with 626 trim by default.

¹ 630 and 619 finishes available only on 98 Series.

² 613 finish has 710 finish device with 613 parts.

Door opening height - must be specified when placing an order. Other heights over 10' are available, consult factory for lead time. Non-standard center lines or threshold installed - consult customer support.

DEFAULT ATTRIBUTES

Pricing includes default options shown below. Additional options and configurations available.

Cylinders:	Sex bolts	Door thickness	Scalp plate
Not included	Included	1-3/4"	Included

Strike(s): Exit hardware:
 ■ Includes 150 and 450 strikes

Fire exit hardware:
 ■ Includes 150 and 450 strikes

22 SERIES
33A/35A SERIES
55 SERIES
88 SERIES
98/99 SERIES
XP98/XP99 SERIES
94/95 SERIES
GUARD-X SERIES
ACCESSORIES / PARTS
ELECTRICAL / PARTS

98/99 SERIES

605	606	611	612	613	619	622	625	626	626AM	628	629
US3	US4	US9	US10	US10B	US15	US19	US26	US26D	US26DAM	US28	US32
630	630AM	643e	689	691	693	695	706	710	711	721	728
US32D	US32DAM	-	SP28	SP10	SPBLK	SP313	SP4	313	315	US3A	US4A

Pool exit hardware (52)

Designed to meet specific needs of pool enclosures. Weather-resistant (WR) components ideal for outdoor applications.

ACN							PRICE BASED ON FINISH					Default trim, included
Device type	Function	Fire	Finish	Device size	Handing	Lever design	626	710				
EXIT HARDWARE							3' DEVICE PRICING SHOWN. 4' ADD \$26.00 LIST					
[98/99]52	EO	.	[] . [] .				\$2,724	\$2,637				N/A
[98/99]52	L	.	[] . [] . [] . []				\$3,266	\$3,179				252L ¹
[98/99]52	L-BE	.	[] . [] . [] . []				\$3,266	\$3,179				252L-BE ¹

¹ 98/9952 x 252L/LBE template (47273677) can be ordered at no charge if needed before installation.

Compliance specification:

UL Listed for panic exit hardware (UL 305)
 ANSI/BHMA A156.3 - 2014, Grade 1
 Meets International Building Code for Pool Enclosures
 Compliant with 2010 ADA Standards for Accessible Design

DEFAULT ATTRIBUTES

Pricing includes default options shown below. Weep Holes option available. No additional options and configurations available. Consult factory for any questions.

Strike(s):

- Exit hardware:
- 98/9952L and 98/9952L-BE devices Include 699 strike
 - 98/9952EO devices Include 699 and 299 strikes

ADDITIONAL TRIM AND STRIKE OPTIONS

Trim	628	695
252L	\$630.00	\$630.00
252L-BE	\$630.00	\$630.00

Strike	622	628	695
699	\$165.00	\$165.00	\$165.00

OPTIONS

605	606	611	612	613	619	622	625	626	626AM	628	629
US3	US4	US9	US10	US10B	US15	US19	US26	US26D	US26DAM	US28	US32
630	630AM	643e	689	691	693	695	706	710	711	721	728
US32D	US32DAM	-	SP28	SP10	SPBLK	SP313	SP4	313	315	US3A	US4A

LESS BOTTOM ROD (LBR/LBL Fire-Rated Devices must be ordered in pairs, and one Auxiliary Fire Pin (AFL) is furnished per pair.)	Specify (Suffix)	Price adjustment
98/9927LBR	LBR	-\$164.00
98/9927-F-LBR (First Leaf)	LBR	\$0.00
98/9927-F-LBR-AFL (Second Leaf)	LBR-AFL	\$0.00
98/9947LBR	LBR	-\$179.00
98/9947-F-LBR (First Leaf)	LBR	\$0.00
98/9947-F-LBR-AFL (Second Leaf)	LBR-AFL	\$0.00
98/9947WDC-LBR	LBR	-\$179.00
98/9947WDC-F-LBR (First Leaf)	LBR	\$0.00
98/9947WDC-F-LBR-AFL (Second Leaf)	LBR-AFL	\$0.00

LESS BOTTOM LATCH (LBR/LBL Fire-Rated Devices must be ordered in pairs, and one Auxiliary Fire Pin (AFL) is furnished per pair.)	Specify (Suffix)	Price adjustment
98/9949LBL	LBL	-\$178.00
98/9949-F-LBL (First Leaf)	LBL	-\$178.00
98/9949-F-LBL-AFL (Second Leaf)	LBL-AFL	\$38.00
98/9950WDC-LBL	LBL	-\$177.00
98/9950WDC-F-LBL (First Leaf)	LBL	-\$177.00
98/9950WDC-F-LBL-AFL (Second Leaf)	LBL-AFL	\$40.00

ANTIMICROBIAL COATING - Available in 626 (US26D) and 630 (US32D), use suffix "AM" when ordering. Example: 626AM	Specify (Suffix)	Price adjustment
For device with or without trim	AM	\$97.00
For trim only	AM	\$45.00

CYLINDER DOGGING - Not for use with fire exit hardware	Specify (Prefix)	Price adjustment
Standard baseplate cylinder dogging ³	CD	\$138.00
Chexit cylinder dogging ¹	CD-CXA	\$631.00
Cylinder dogging indicator ²	CI	\$382.00
Dogging indicator ³	DI	\$359.00
Less dogging	LD	\$0.00
Cylinder dogging with indicator	CDSI	\$458.00
Hex dogging with indicator	HDSI	\$329.00
Special center case dogging - panic only ⁴	SD	\$586.00

¹ Available on all 98/99 Chexit panic devices.

² Not available with EL/QEL, Chexit or 2' devices.

³ Available on all 98/99 panic devices. Excludes 2' device.

⁴ Available on 98/99 Rim/27/47/48/49/57/50WDC panic devices only. May be used with EL/QEL option, refer to page 99 for pricing. Specify handing.

OPTIONS

605	606	611	612	613	619	622	625	626	626AM	628	629
US3	US4	US9	US10	US10B	US15	US19	US26	US26D	US26DAM	US28	US32
630	630AM	643e	689	691	693	695	706	710	711	721	728
US32D	US32DAM	-	SP28	SP10	SPBLK	SP313	SP4	313	315	US3A	US4A

TRIM CYLINDER LOCKDOWN	Specify (Suffix)	Price adjustment
Double Cylinder ^{1,2,3}	-2	\$478.00
Double Cylinder with Security Indicator ^{1,2,3}	-2SI	\$799.00

¹ Must be ordered with 996-2 lever trim. Specify handing.

² Available on 98/99 (Rim), 98/9927, 98/9947, 98/9947WDC, 98/9948, 98/9949, 98/9957, 98/9975. Rim cylinder sold separately. Keyed rim cylinder (20-021) or thumbturn rim cylinders (XB11-979, XB13-379) are available from Schlage.

³ 2-1/4" door with GBK + -2SI is an engineering special. Longer lead times may apply. When rim cylinders with a horizontal tailpiece are used, order 47686979 kit for compatibility. Please contact Customer Care at Exits_TechProdSupport@allegion.com or (877) 671-7011, Option 2.

WARNING: Double cylinder options (2/2SI) are ideal for fire exit hardware and panic hardware that is not equipped with the dogging feature. Combining a double cylinder option with the dogging feature is not recommended, as the hardware could be in the dogged (unlatched) position when the indicator states a locked position.

VON DUPRIN REMOTE UNDOGGING AND REMOTE MONITORING KIT - Access control modular retrofit kit. Consult your access control software provider for pricing and specific scope of support. For details regarding RU or RM please see Kits section within 98/99 Series.

SWITCHES - Available on all 98/99 Series devices	Specify (Prefix)	Price adjustment
Request to Exit	RX	\$365.00
Waterproof Request to Exit	WP-RX	\$529.00
Request to Exit Low Current	RX-LC	\$424.00
Request to Exit Double Switch	RX-2	\$455.00
RX to RX-2 Conversion (order part number 050271)	RX-AUX	\$380.00
Latch Bolt Monitoring	LX ^{1,2}	\$365.00
Latch Bolt Monitoring Low Current	LX-LC ¹	\$424.00
Request to Exit / Latch Bolt Monitoring combination	LX-RX ¹	\$552.00
Request to Exit / Latch Bolt Monitoring combination Low Current	LX-RX-LC ¹	\$665.00
Signal Switch - for Rim and Vertical Rod Devices, specify handing	SS ³	\$749.00
Signal Switch - for Mortise Device (includes SS7500 lock), specify handing	SS ³	\$1,111.00

¹ For 98/9949, LX switch monitors trim input or electric dogging of EL/QEL devices. LX switch does not monitor latch condition. Not available on 98/9975 mortise device.

² For Latch Bolt Monitoring on 98/9975 Mortise Devices specify the SS7500 lock and add \$365.00 list per device.

³ Signal Switch option includes RSS lettering on push pad and mortise cylinder for alarm bypass.

See page 179-180 for field-installed switch kit part numbers.

LATCH RETRACTION - See 98/99 product catalog for required accessory equipment	Specify (Prefix)	Price adjustment
Electric latch retraction	EL	\$1,337.00
Electric Latch Retraction with Special Center Case Dogging ¹ (Available with "EL" option)	SD-EL	\$1,923.00
Quiet electric latch retraction	QEL	\$1,258.00
Quiet electric latch retraction with hex dogging (panic only)	HD-QEL	\$1,258.00
Quiet Electric Latch Retraction with Special Center Case Dogging ¹ (Available with "QEL" option)	SD-QEL	\$1,844.00
Quiet electric latch retraction for AX devices	QELX	\$1,338.00
Quiet electric latch retraction with hex dogging (panic only) for AX devices	HD-QELX	\$1,338.00
Quiet electric latch retraction - latch bolt only (includes RX switch)	QEL-L	\$2,217.00
Pneumatic	PN	\$2,042.00

¹ Available only on 98/99 Rim/27/47/48/49/50/57 panic devices. Specify handing.

EMERGENCY SECURE LOCKDOWN	Specify (Prefix)	Price adjustment
<ul style="list-style-type: none"> No WS; no mechanical dogging of QEL (SD-QEL, HD-QEL) Unit requires a standard 1 1/4" (32mm) mortise cylinder with an inverted straight cam and compression ring and spring. Kit does not come with cylinder or thumbturn, must be ordered separately. Examples: Schlage conventional cylinder: 20-001 1 1/4" XQ11-949; Schlage thumbturn cylinder: 09-904 1 1/4" B502-191 XQ11-949; Schlage ADA thumbturn cylinder: 09-904 1 1/4" XB11-720 B502-191 XQ11-949 Install in alignment with 2018 IBC 1010.2.8 NFPA 101 14.2.2.2.4 or per local AHJ - Only allowed with trim functions: NL, K-NL, L-NL, NL-OP, T-NL 	ESL	\$586.00

OPTIONS

605	606	611	612	613	619	622	625	626	626AM	628	629
US3	US4	US9	US10	US10B	US15	US19	US26	US26D	US26DAM	US28	US32
630	630AM	643e	689	691	693	695	706	710	711	721	728
US32D	US32DAM	-	SP28	SP10	SPBLK	SP313	SP4	313	315	US3A	US4A

QUIET MECHANICAL	Specify (Prefix)	Price adjustment
Quiet mechanical: Controls motion to reduce operational noise. The QM device option provides damper-controlled re-latching. Available on 98/99 rim and 98/9927 devices. Compatible with most of the device options including QEL, EL, AX, RX, and CD. Not available with CX and LX. Specify QM996 if quiet trim is desired.	QM	\$266.00

CHEXIT - Available on all 98/99 Series devices	Specify (Prefix)			Price adjustment
	Prefix	Finish	Release delay	
Chexit – Controlled exit device (15 second delay furnished standard) <ul style="list-style-type: none"> DT Function requires an electric strike to access opening Chexit is not available with any electrical options (EL, QEL, PN) Chexit is not available with any switches (RX, RXLC, RX2, WP-RX, LX, LXLC, LXR, LXRXL, SS) For CX98/9927 and CX98/9957 panic and fire devices, two Rod Guards (RGO) supplied standard. Add \$830.00 list per device. For doors over 7' additional RGO's will be added as needed to protect the rods. For each additional RGO, add \$415.00 list. For latch protection, latch guards (LGO) found on page 166 can be ordered separately 	CXA	-	.[Release delay]	\$2,667.00
Remote Chexit module	RCM	.[Finish]	.[Release delay]	\$382.00
Chexit 10' cable	CXCAB	-	-	\$171.00

RELEASE DELAY	Specify	Price adjustment
0 Second Delay	0 Delay	\$194.00
30 Second Delay ¹	30 Delay	\$194.00
15 second delay with BOCA Modification ²	BOCA-15 Delay	\$194.00
30 second delay with BOCA Modification ¹ ²	BOCA-30 Delay	\$194.00
2-60 Seconds in 2 Second Intervals or infinite delay ¹ ²	Other Delays	\$263.00

15 second Module sold separately, specify part number 040086.

¹ Over 15 second delay requires a letter of approval from the authority having local jurisdiction over the premises prior to the installation of the device. Allegion cannot grant such approval nor does it warrant local jurisdiction compliance.

² Consult factory for lead time.

EXIT ALARM	Specify	Price adjustment
Exit alarm <ul style="list-style-type: none"> Available on 98/99 Series panic and fire devices Price includes RX switch; can substitute with LX switch at no additional charge For vertical rod tampering monitoring on Surface Vertical Devices, specify device with LX (Latch Bolt Monitor Switch) To order Less switch, deduct \$365.00 list 9 volt battery included 	ALK	\$907.00

PULLMAN LATCHES - Not for use with fire exit hardware	Specify	Price adjustment
98/9927 device PL top and PL bottom	PL	\$356.00
98/9947 device PL top and PL bottom	PL	\$498.00
98/9927 device LBR with PL top latch for electric strike application (a panic LBR device is one-point latching not two point, the security of the opening may be compromised)	ES	\$178.00
98/9947 device LBR with PL top latch for electric strike application (a panic LBR device is one-point latching not two point, the security of the opening may be compromised)	ES	\$249.00

OPTIONS

605	606	611	612	613	619	622	625	626	626AM	628	629
US3	US4	US9	US10	US10B	US15	US19	US26	US26D	US26DAM	US28	US32
630	630AM	643e	689	691	693	695	706	710	711	721	728
US32D	US32DAM	-	SP28	SP10	SPBLK	SP313	SP4	313	315	US3A	US4A

ELECTRIC UNLOCKING	Specify (Prefix)	Price adjustment
Electric unlocking of outside lever for all 98/9975 mortise devices. Available with TP, K, or L functions only. "AC" current requires SO12 or SO24 rectifier kit. Add \$61.00 list per device. Specify FAIL SECURE (FSE) or FAIL SAFE (FS). SO rectifier kit intended for fail secure / momentary use only. Contact product support for assistance.	E	\$909.00
Motor Driven Electric Unlocking of outside M996 Trim - for 98/99 rim, mortise, surface vertical and concealed vertical devices. Available with L or LBE functions only. Specify handing. Dual voltage - works with either 12 or 24 VDC power supplies, furnished Fail Safe (FS) but can be converted in the field with dip switch without mechanical conversion. See page 146 for pricing and optional lever designs.	M996	\$916.00

STORM RATING

HURRICANE DEVICE - USE WITH APPROVED ALLEGION DOOR APPLICATIONS

Specify HH (Wind and Impact) or HW (Wind-Only) prefix when ordering devices or mullions for hurricane applications. If application is unknown, specify HH which will satisfy the requirements for both applications. HH option only available for select series and models. HH/HW devices will be furnished with strikes shown in charts (and with through bolts if HH product) and are price-adjusted as indicated. Mullions priced separately.

HH (WIND AND IMPACT)

Model	Door mode	Mullion	Standard strike	Specify (Prefix)	Price adjustment
98/99 Rim	SGL	-	299F	HH	\$135.00
98/99 Rim	PR	HH9954	499F	HH	\$285.00
98-F/99-F	PR	HH9954	499F	HH	\$264.00
98-F/99-F Rim	SGL	-	299F	HH	\$114.00
9827/9927	SGL or PR	-	Top: 299F Bottom: 304L	HH	\$53.00
9827-F/9927-F	PR	-	Top: 299F Bottom: 304L	HH	\$114.00
HH9847/9947	SGL or PR	-	Top: 338 Bottom: 304L	-	\$17.00
9847-F/9947-F	PR	-	Top: 338 Bottom: 304L	HH	\$17.00
9849/9949	SGL or PR	-	Top: 249 Bottom: 349	HH	\$114.00
9849-F/9949-F	PR	-	Top: 249 Bottom: 349	HH	\$114.00
9857/9957	SGL	-	Top: 299F Middle: 299F Bottom: 304L	HH	\$74.00
9857/9957	PR	HH9954	Top: 299F Middle: 499F Bottom: 304L	HH	\$224.00
9857-F/9957-F	PR	HH9954	Top: 499F Middle: 499F Bottom: 304L	HH	\$414.00
9857-F/9957-F	SGL	-	Top: 299F Middle: 299F Bottom: 304L	HH	\$74.00
9875/9975	SGL	-	575	HH	\$114.00
9875/9975-F	SGL	-	575	HH	\$114.00

HW (WIND ONLY)

Model	Door mode	Mullion	Standard strike	Specify (Prefix)	Price adjustment
98/99 Rim	SGL	-	299	HW	\$0.00
98/99 Rim	PR	4954 or KR4954	299	HW	\$0.00
98-F/99-F Rim	SGL	-	299F	HW	\$0.00
98-F/99-F	PR	9954 or KR9954	499F	HW	\$150.00
9827/9927	SGL or PR	-	Top: 299 Bottom: 304L	HW	-\$82.00
9827-F/9927-F	PR	-	Top: 299F Bottom: 304L	HW	\$0.00
9847/9947	SGL or PR	-	Top: 338 Bottom: 304L	HW	-\$97.00
9847-F/9947-F	PR	-	Top: 338 Bottom: 304L	HW	-\$97.00
9849/9949	SGL or PR	-	Top: 249 Bottom: 349	HW	\$0.00
9849-F/9949-F	PR	-	Top: 249 Bottom: 349	HW	\$0.00
9857/9957	SGL	-	Top: 299 Middle: 299 Bottom: 304L	HW	-\$82.00
9857/9957	PR	4954 or KR4954	Top: 299 Middle: 299 Bottom: 304L	HW	-\$82.00
9857-F/9957-F	SGL	-	Top: 299F Middle: 299F Bottom: 304L	HW	\$0.00
9857-F/9957-F	PR	9954 or KR9954	Top: 299F Middle: 499F Bottom: 304L	HW	\$150.00

OPTIONS

605	606	611	612	613	619	622	625	626	626AM	628	629
US3	US4	US9	US10	US10B	US15	US19	US26	US26D	US26DAM	US28	US32
630	630AM	643e	689	691	693	695	706	710	711	721	728
US32D	US32DAM	-	SP28	SP10	SPBLK	SP313	SP4	313	315	US3A	US4A

STORM RATING

HURRICANE DEVICE - USE WITH APPROVED ALLEGION DOOR APPLICATIONS

Specify HH (Wind and Impact) or HW (Wind-Only) prefix when ordering devices or mullions for hurricane applications. If application is unknown, specify HH which will satisfy the requirements for both applications. HH option only available for select series and models. HH/HW devices will be furnished with strikes shown in charts (and with through bolts if HH product) and are price-adjusted as indicated. Mullions priced separately.

HW (WIND ONLY)

Model	Door mode	Mullion	Standard strike	Specify (Prefix)	Price adjustment
9875/9975	SGL	-	575	HW	\$0.00
9875-F/9975-F	SGL	-	575	HW	\$0.00

WS (WINDSTORM DEVICE)¹

Certified to comply with ICC 500 Standard for the Design and Construction of Storm Shelters, and the Federal Emergency Management Agency's publication FEMA 361 — Design and Construction Guidance for Community Safety. Devices are listed with Steelcraft Paladin doors for tornado listings and Steelcraft "H" Series doors for Wind and Impact (HH) Hurricane applications.

- Available on the 98/9927² and 98/9957³ Series devices
- Available with QEL and M996L-BE trim only
- Not available with EL option, LNL/NL trim function, and M996L trim

WS	\$1,706.00
----	------------

¹ Miami-Dade Co. / FBC will list compliance to: TAS 201, TAS 202, TAS 203. Design Load Rating: +150/-150 PSF (245 MPH Wind Zone). Enhanced Hurricane Protection (EHPA) ASTM E1996 / ANSI/ICC 500 (245 MPH Wind Zone) / UL - ANSI/ICC 500 certified of F5 - Tornado applications.

² Door applications for WS98/9927 - 8'0" x 8'0" Pairs (swing same direction) 4'0" x 8'0" Single (non-fire rated only) Flush Hollow Metal. UL - FEMA 361 certified.

³ Door applications for WS98/9957 - 4'0" x 8'0" Single (fire and non-fire rated) Flush Hollow Metal. UL-FEMA 361 certified.

ACCESSIBLE DEVICE

- Accessible device compliant with the California Building Code (Section 11B-309.4) requirement for 5 lb. maximum operational force.
- Available on AX98/99, AX98/99-F Rim, AX98/9949 LBL, LBL-AFL, AX98/9927-LBR, AX98/9927-LBR-F, 98/9950WDC-LBL and 98/9950WDC-LBL-F
- Trim functions available EO, DT, NL, L, LBE, LDT and LNL
- EL and QELX options available
- Not available with CX

Specify (Prefix)	Price adjustment
AX	\$89.00

TOUCHBAR OPTIONS

Vision impaired touchpad, raised letters and braille, 630 finish. Standard reads "Caution Stairwell." Optional up to 20 alpha / numeric characters on single line, consult factory.

Brass, bronze and stainless touchbar trims embossed "PUSH". No additional charge when specified with device.

Red silk-screened lettered touchbar trims (standard on SS devices). "Emergency Exit Only, Push to Open and Sound Alarm" No additional charge when specified with device.

Knurled touchpad. No additional charge when specified with device.

Safety glow feature for 3' device

Safety glow feature for 4' device

Pushbar Armor - built to absorb impact and provides added support, while protecting the pushbar on hinge side of device.

Specify		Price adjustment
Suffix	Handing	
BRAILLE	.[RHR, LHR]	\$180.00
EMB	.[RHR, LHR]	\$0.00
RSS	.[RHR, LHR]	\$0.00
KN	-	\$0.00
SG	-	\$652.00
SG	-	\$678.00
Prefix	Handing	\$27.00
PA	-	

Custom graphics available on touchbar trim. See page 7 for details.

WEEP HOLES

Drainage (weep) holes in mechanism case. 3' device will have 4 holes - 6" spacing, 4' device will have 6 holes

Specify	Price adjustment
WH	\$128.00

CONNECTORS

Cross-category solution using interconnect components for electrified options. Available with ALK, LX, LXLC, LXR, LXRXC, RX, RXLC, and WPRX switches, EL, QEL, CX, M996, E7500, SS7500

Specify	Price adjustment
CON	\$0.00

OPTIONS

605	606	611	612	613	619	622	625	626	626AM	628	629
US3	US4	US9	US10	US10B	US15	US19	US26	US26D	US26DAM	US28	US32
630	630AM	643e	689	691	693	695	706	710	711	721	728
US32D	US32DAM	-	SP28	SP10	SPBLK	SP313	SP4	313	315	US3A	US4A

NON-STANDARD DOOR THICKNESS Door thickness > 2-1/4" - ≤ 4-1/4"	Specify	Price adjustment
98/99 Rim, 98/9947/47WDC, 98/9948, 98/9949, 98/9950WDC with EO (exit only no trim), with sex bolts	.DT[]	\$128.00
98/99 Rim, 98/9947/47WDC, 98/9948, 98/9949, 98/9950WDC with NL-OP (with 110NL cylinder control), with sex bolts	.DT[]	\$256.00
98/99 Rim, 98/9947/47WDC, 98/9948, 98/9949, 98/9950WDC with NL-OP (with 110NL cylinder control), no sex bolts	.DT[]	\$128.00
98/9927, 98/9957 devices EO (exit only no trim), with or without sex bolts	.DT[]	\$128.00
98/9927, 98/9957 devices NL-OP (with 110NL cylinder control), with or without sex bolts.	.DT[]	\$256.00

For devices with other trim, see page 16 for trim list adders.

INSULCLAD OR APPLIED PANEL - Not available for fire door applications	Specify	Price adjustment/ price each
1/2" Panel - for 98/9947 devices ¹	INS-2	\$96.00
1/4" Panel - for 98/9947 devices	INS-4	\$96.00
1/2" Panel - for 98/9949 devices	INS-2	\$96.00
1/4" Panel - for 98/9949 devices	INS-4	\$96.00

¹ Available only with 996L-NL/L-DT/K-NL/K-DT/EO, 110NL-OP, 990EO trims, and EO devices.

KITS

QUIET MECHANICAL RETROFIT KITS	Specify	Price each
QM Rim Device Retrofit Kit - 98/99 Rim	47259560	\$266.00
QM SVR Device Retrofit Kit - 98/9927A	47263418	\$266.00

EL CONVERSION KITS - Field conversion kits for Electric Latch Retraction	Specify				Price each
	Standard		Allegion Connect -CON		
	3' device	4' device	3' device	4' device	
EL baseplate conversion kit	050070	050078	050853	050854	\$1,555.00

QEL CONVERSION KITS - Field conversion kits for Quiet Electric Latch Retraction	Specify				Price each
	Standard		Allegion Connect -CON		
	3' device	4' device	3' device	4' device	
Baseplate conversion kits (may be used for ANY conversion application)					
QEL baseplate conversion kit	958003	040065	040063	040066	\$1,323.00
HD-QEL baseplate conversion kit (hex dogging included, panic only)	958004	040067	040064	040068	\$1,323.00
QELX baseplate conversion kit for AX devices	041166	041167	041168	041169	\$1,402.00
HD-QELX Baseplate Conversion Kit for AX devices (hex dogging included, panic only)	041170	041171	041172	041173	\$1,402.00
Modular conversion kits (for non-EL panic devices, for non-EL fire-rated devices sold after October 2014, or for replacing existing motor)	Standard		Allegion Connect -CON		Price each
	3' device	4' device	3' device	4' device	
QEL modular conversion kit	114317	114317	040061	040061	\$1,258.00
HD-QEL modular conversion kit (hex dogging included, panic only)	958002	958002	040062	040062	\$1,258.00
QELX modular conversion kit for AX devices	041162	041162	041163	041163	\$1,338.00
HD-QELX modular conversion kit for AX devices (hex dogging Included, panic only)	041164	041164	041165	041165	\$1,338.00
QEL-L modular latch retraction (latchbolt only, includes RX switch)	47895915	47895918	47897871	47897873	\$2,217.00

KITS

605	606	611	612	613	619	622	625	626	626AM	628	629
US3	US4	US9	US10	US10B	US15	US19	US26	US26D	US26DAM	US28	US32
630	630AM	643e	689	691	693	695	706	710	711	721	728
US32D	US32DAM	-	SP28	SP10	SPBLK	SP313	SP4	313	315	US3A	US4A

QEL BUZZER	Specify	Price each
QEL-B modular buzzer kit	47856044	\$357.00

ESL (EMERGENCY SECURE LOCKDOWN) KITS	Specify			Price each
	3' device	4' device	Finish	
98 ESL Kit - Retrofit kit for QEL 98 devices; Panic or Fire (not available in 619 or 630)	967244	967245	.[Finish]	\$586.00
99 ESL Kit - Retrofit kit for QEL 99, devices; Panic or Fire	967246	967247	.[Finish]	\$586.00

- No WS
- No mechanical dogging of QEL (SD-QEL, HD-QEL)
- Unit requires a standard 1 1/4" (32mm) mortise cylinder with an inverted straight cam and compression ring and spring. Kit does not come with cylinder or thumbturn, must be ordered separately. Examples: Schlage conventional cylinder: 20-0011 1/4" XQ11-949; Schlage thumbturn cylinder: 09-904 1 1/4" B502-191 XQ11-949; Schlage ADA thumbturn cylinder: 09-904 1 1/4" XB11-720 B502-191 XQ11-949
- Install in alignment with 2018 IBC 1010.2.8 NFPA 101 14.2.2.2.4 or per local AHJ - Only allowed with trim functions: NL, K-NL, L-NL, NL-OP, T-NL

98/99 -2 CONVERSION AND CENTER CASE COVER KITS												
Description	Specify						628 695 711	626	630	612	606	605 619 625 643E
	Part number	Double cylinder	Device type	Fire	Finish	Handing						
98/99-2 Conversion Kit ^{1,2}	2SIKIT	.-2	.[]	.[F]	.[Finish]	.[Handing]	\$1,561.00	\$1,642.00	\$1,708.00	\$1,708.00	\$1,642.00	\$1,561.00
98/99-2SI Conversion Kit ^{1,2}	2SIKIT	.-2SI	.[]	.[F]	.[Finish]	.[Handing]	\$1,916.00	\$2,003.00	\$2,061.00	\$2,061.00	\$2,061.00	\$1,916.00
98/99-2 Center Case Cover Kit ³	CC-CVR	.-2	.[]	-	.[Finish]	.[Handing]	\$264.00	\$307.00	\$345.00	\$307.00	\$307.00	\$264.00
98/99-2SI Center Case Cover Kit ³	CC-CVR	.-2SI	.[]	-	.[Finish]	.[Handing]	\$272.00	\$315.00	\$354.00	\$315.00	\$315.00	\$272.00

¹ 2SI and -2 kits are available for panic and fire-rated 98/99 rim, 98/9927, 98/9947,98/9947WDC, 98/9948, 98/9949, 98/9957,and 98/9975.
² Kits include components for updating 996 and 994 lever trims.
³ 2SI and -2 center case cover kits are available for 98/99 rim, 98/9927, 98/9947,98/9947WDC, 98/9948, 98/9949, 98/9957,and 98/9975.

DOUBLE CYLINDER MODULE SERVICE KIT	Specify		622, 605, 606, 612, 625, 626, 689, 695
	Part number	Finish	
2SI Module Service Kit	47448783	.[Finish]	\$166.00
-2 Module Service Kit	47448784	.[Finish]	\$166.00

DOUBLE CYLINDER ADAPTER KIT	Specify		643E, 605, 606, 619, 622, 625, 626, 689, 695, 612
	Part number	Finish	
Allows customer to use a horizontal tailpiece cylinder with -2/-2SI	47686979	.[Finish]	\$156.00

KITS

605	606	611	612	613	619	622	625	626	626AM	628	629
US3	US4	US9	US10	US10B	US15	US19	US26	US26D	US26DAM	US28	US32
630	630AM	643e	689	691	693	695	706	710	711	721	728
US32D	US32DAM	-	SP28	SP10	SPBLK	SP313	SP4	313	315	US3A	US4A

<p>VON DUPRIN REMOTE UNDOGGING AND REMOTE MONITORING KIT</p> <ul style="list-style-type: none"> Modular retrofit kit for 98/99 and 33A/35A Series rim, SVR, CVR, CVC and 3-point devices Access control managed via an IP or RSI/ RS-485 connection to the gateway through Allegion software alliance members ENGAGE enabled undogging available. See RU/RM data sheet. 	<p>Consult your access control software provider for pricing and specific scope of support.</p>
---	---

REMOTE UNDOGGING AND REMOTE MONITORING	Specify		Price each
	Part number	Finish	
Remote Undogging (RU) 3' kit	47258681	.[Finish]	\$1,397.00
Remote Undogging (RU) 4' kit	47258682	.[Finish]	\$1,397.00
Remote Monitoring (RM) 3' kit	47258683	.[Finish]	\$1,067.00
Remote Monitoring (RM) 4' kit	47258684	.[Finish]	\$1,067.00

- ENGAGE gateway sold separately.
- Specify CON for Allegion Connect
- RU option:
 - Enables both remote undogging and door status monitoring (DPS, RX and LX)
 - Not compatible with exit devices with the following options: QEL, DI/CDSI/HDSI, RX2, Schlage AD/CO Trim, SD, SS, PN, E-Strikes/Pullman Latch, CX
 - Compatible device lengths: All 33A/35A and 98/99 device types – 3' (914 mm) length to 2' 9" (838 mm), 4' (1219 mm) length to 3' 3" (991 mm)
- RM option:
 - Enables door status monitoring (DPS, RX and LX) only
 - Not compatible with exit devices with the following options: DI/CDSI/HDSI, RX2, Schlage AD/CO Trim, SD, SS, PN, E-Strikes/Pullman Latch, CX
 - If the door and exit device are fire rated, and the exit device type is a 98/99-F Rim manufactured prior to April 1, 2018, a new center case will be required before proceeding with the installation of the RM kit. 98/99-F Rim Center Case Kit Less Cover, part number 050026.

CX OPTIONS	Specify		Price each
	Part number	Finish	
RCM KIT-98 Less Module	040199	.[Finish]	\$381.00
RCM KIT-99 Less Module	040198	.[Finish]	\$381.00

ELECTRICAL UNLOCKING RETROFIT KITS	Specify	Price each
996 R/V/C Conversion to M996 Motorized Kit	47273111	\$998.00
996 Mort Conversion to M996 Motorized Kit	47273112	\$1,040.00

LBR/LBL RETROFIT KITS FOR FIRE-RATED DEVICES	Specify	Price each
98/9927-F LBR Kit - Auxiliary fire pin and two required 499F strikes	050171-32	\$657.00
98/9947-F/47WDC-F/49-F LBR/LBL Kit - Auxiliary fire pin only	051860-32	\$216.00
98/9950WDC-F LBL Kit - Auxiliary fire pin, auxiliary fire latch strike, sleeve and screws	48968887	\$233.00

KITS

605	606	611	612	613	619	622	625	626	626AM	628	629
US3	US4	US9	US10	US10B	US15	US19	US26	US26D	US26DAM	US28	US32
630	630AM	643e	689	691	693	695	706	710	711	721	728
US32D	US32DAM	-	SP28	SP10	SPBLK	SP313	SP4	313	315	US3A	US4A

49 CABLE SYSTEM Device type and door opening height must be specified when ordering	Specify			Price each
	Device type	Part number	Door height Specify height between 6'0" - 10'0"	
Complete cable system Includes: Top and bottom strikes, latches, centerslides, cables and mounting packs	[]	CS	[]	\$1,385.00
Cable system, less bottom latch Includes: Top strike, top latch, top cable, centerslides and mounting packs	[]	CS-LBL	[]	\$1,207.00
Cable system, less bottom latch with fire pin kit Includes: Top strike, top latch, top cable, centerslides, mounting packs and fire pin kit	[]	CS-LBL-49AFL	[]	\$1,424.00

For door opening heights less than 6'10" and more than 10', consult factory.
Consult customer support for non-standard center lines or if a threshold is installed.

50 WDC CABLE SYSTEM Device type and door opening height must be specified when ordering	Specify			Price each
	Device type	Part number	Door height Specify height between 6'0" - 10'0"	
Complete cable system Includes: Top and bottom latches, strikes, cables, centerslide and mounting packs	[]	CS	[]	\$1,586.00
Fire-rated complete cable system Includes: Top and bottom latches, strikes, cables, centerslide, mounting packs, fire kit	[]	CS-F	[]	\$2,003.00
Cable system - Less bottom latch Includes: Top latch, strike, cable, centerslide and mounting packs	[]	CS-LBL	[]	\$1,407.00
Fire-rated cable system - Less bottom latch Includes: Top latch, strike, cable, centerslide, mounting packs, fire kit, fire pin kit	[]	CS-LBL-F	[]	\$2,003.00

INSULCLAD OR APPLIED PANEL KITS - Not available for fire door applications	Specify	Price each
1/2" Panel Kit - for 98/9947 devices ¹	051841-00	\$374.00
1/4" Panel Kit - for 98/9947 devices	051842-00	\$227.00
1/2" Panel Kit - for 98/9949 devices	24122285	\$96.00
1/4" Panel Kit - for 98/9949 devices	24122327	\$96.00

¹ Available only with 996L-NL/L-DT/K-NL/K-DT/EO, 110NL-OP, 990EO trims, and EO devices.

PARTS AND ACCESSORIES

605	606	611	612	613	619	622	625	626	626AM	628	629
US3	US4	US9	US10	US10B	US15	US19	US26	US26D	US26DAM	US28	US32
630	630AM	643e	689	691	693	695	706	710	711	721	728
US32D	US32DAM	-	SP28	SPIO	SPBLK	SP313	SP4	313	315	US3A	US4A

CENTER CASE

Description	Specify		Non-finished	628 710 711	626	✓ 630	612	606	605 ✓ 619 625 643e
	Part number	Finish							
98/99 Rim Center Case Kit Less Cover	050020	-	\$648.00	-	-	-	-	-	-
98/99-F Rim Center Case Kit Less Cover	050026	-	\$676.00	-	-	-	-	-	-
98/9927/-F Center Case Kit Less Cover	050021	-	\$349.00	-	-	-	-	-	-
98/9947/48/-F Center Case Kit Less Cover	050022	-	\$895.00	-	-	-	-	-	-
98/9975/-F Center Case Kit Less Cover	050023	-	\$252.00	-	-	-	-	-	-
SD98/99/57 RHR Rim Center Case Kit Less Cover	050548	-	\$1,081.00	-	-	-	-	-	-
SD98/99/57 LHR Rim Center Case Kit Less Cover	050549	-	\$1,081.00	-	-	-	-	-	-
SD98/9927 RHR Center Case Kit Less Cover	050550	-	\$796.00	-	-	-	-	-	-
SD98/9927 LHR Center Case Kit Less Cover	050551	-	\$796.00	-	-	-	-	-	-
SD98/9947/48/49 RHR Center Case Kit Less Cover	050552	-	\$1,111.00	-	-	-	-	-	-
SD98/9947/48/49 LHR Center Case Kit Less Cover	050553	-	\$1,111.00	-	-	-	-	-	-
WS98/9927 Center Case RHR Less Cover	101024	-	\$648.00	-	-	-	-	-	-
WS98/9927 Center Case LHR Less Cover	101023	-	\$648.00	-	-	-	-	-	-
WS98/9957 Center Case RHR Less Cover	24086894	-	\$648.00	-	-	-	-	-	-
WS98/9957 Center Case LHR Less Cover	24086860	-	\$648.00	-	-	-	-	-	-
SD98/99 Rim Conversion Kit RHR	050386	[Finish]	-	\$1,561.00	\$1,642.00	\$1,708.00	\$1,708.00	\$1,642.00	\$1,724.00
SD98/99 Rim Conversion Kit LHR	050387	[Finish]	-	\$1,561.00	\$1,642.00	\$1,708.00	\$1,708.00	\$1,642.00	\$1,724.00
98/99-2SI Center Case Cover Kit RHR (Old Style -2SI)	050831	[Finish]	-	\$272.00	\$315.00	\$354.00	\$315.00	\$315.00	\$376.00
98/99-2SI Center Case Cover Kit LHR (Old Style -2SI)	050832	[Finish]	-	\$272.00	\$315.00	\$354.00	\$315.00	\$315.00	\$376.00
98/99/-F Center Case Cover Kit	050071	[Finish]	-	\$203.00	\$293.00	\$307.00	\$293.00	\$293.00	\$337.00
98/9927/27-F Center Case Cover Kit	050072	[Finish]	-	\$203.00	\$293.00	\$307.00	\$293.00	\$293.00	\$337.00
98/9947/47/49/75/75-F Center Case Cover Kit	050073	[Finish]	-	\$203.00	\$293.00	\$307.00	\$293.00	\$293.00	\$337.00
98/9957/-F Center Case Cover Kit	050554	[Finish]	-	\$203.00	\$293.00	\$307.00	\$293.00	\$293.00	\$337.00
98/99SD RHR Center Case Cover Kit	050555	[Finish]	-	\$264.00	\$307.00	\$345.00	\$307.00	\$307.00	\$367.00
98/99SD LHR Center Case Cover Kit	050556	[Finish]	-	\$264.00	\$307.00	\$345.00	\$307.00	\$307.00	\$367.00
98/9975-2 RHR Center Case Cover Kit (Old Style -2)	050557	[Finish]	-	\$264.00	\$307.00	\$345.00	\$307.00	\$307.00	\$367.00
98/9975-2 LHR Center Case Cover Kit (Old Style -2)	050558	[Finish]	-	\$264.00	\$307.00	\$345.00	\$307.00	\$307.00	\$367.00
CX-CD/SD98/9927 RHR Center Case Cover Kit	050559	[Finish]	-	\$272.00	\$315.00	\$355.00	\$315.00	\$315.00	\$378.00
CX-CD/SD98/9927 LHR Center Case Cover Kit	050560	[Finish]	-	\$272.00	\$315.00	\$355.00	\$315.00	\$315.00	\$378.00
CX-CD/SD98/9947 RHR Center Case Cover Kit	050562	[Finish]	-	\$272.00	\$315.00	\$355.00	\$315.00	\$315.00	\$378.00
CX-CD/SD98/9947 LHR Center Case Cover Kit	050563	[Finish]	-	\$272.00	\$315.00	\$355.00	\$315.00	\$315.00	\$378.00
Control Link Pin Kit	050529	-	\$19.00	-	-	-	-	-	-
Retaining Ring Pkg/10	090107	-	\$19.00	-	-	-	-	-	-
Control Link Pin Pkg/10	090031	-	\$24.00	-	-	-	-	-	-
NL Drive Screw Pkg/10	090074	-	\$30.00	-	-	-	-	-	-
Latch Bolt Pin Pkg/10	090079	-	\$19.00	-	-	-	-	-	-
Center Case Cover Bracket	050564	-	\$24.00	-	-	-	-	-	-

For Antimicrobial Finishes add \$15.00 to list. ✓ 630 and 619 finishes available with Series 98 only.

PARTS AND ACCESSORIES

605	606	611	612	613	619	622	625	626	626AM	628	629
US3	US4	US9	US10	US10B	US15	US19	US26	US26D	US26DAM	US28	US32
630	630AM	643e	689	691	693	695	706	710	711	721	728
US32D	US32DAM	-	SP28	SP10	SPBLK	SP313	SP4	313	315	US3A	US4A

CENTER CASE

Description	Specify		Non-finished	628 710 711	626	✓630	612	606	605 ✓619 625 643e
	Part number	Finish							
Center Case Reinforcing Bracket	050565	-	\$24.00	-	-	-	-	-	-
CD-CX/SD Cylinder Dog Housing	112409	.[Finish]	-	\$208.00	\$208.00	-	\$208.00	\$208.00	\$208.00
CX-CD/SD Cylinder Dog Bracket Kit LHR	112456	-	\$112.00	-	-	-	-	-	-
CX-CD/SD Cylinder Dog Bracket Kit RHR	112455	-	\$112.00	-	-	-	-	-	-
98/99-2 Rim Cylinder Adapter (Old Style -2)	114984	.[Finish]	-	-	\$196.00	-	-	-	-
98/9975-2 LHR Cylinder Adapter (Old Style -2)	113100	.[Finish]	-	-	\$308.00	-	-	-	-
98/9975-2 RHR Cylinder Adapter (Old Style -2)	113101	.[Finish]	-	-	\$308.00	-	-	-	-
Center Case Cover Screws	900892	.[Finish]	-	\$19.00	-	\$19.00	\$19.00	\$19.00	\$19.00
98/9949 HM/AL SD Ctr Slide Mtg	24123291	-	\$227.00	-	-	-	-	-	-
98/99R/57 Device Template Pkg	900594	-	\$15.00	-	-	-	-	-	-
98/9927/47/48/75 Device Template	900595	-	\$15.00	-	-	-	-	-	-

For Antimicrobial Finishes add \$15.00 to list. ✓ 630 and 619 finishes available with Series 98 only.

COVER PLATE / CONVERSION KITS

Description	Specify		Non-finished	628 710 711	626	✓630	612	606	605 ✓619 625 643e
	Part number	Finish							
99 Hex Dog Conversion Kit fits 3' to 4'	050114	.[Finish]	-	\$104.00	-	-	\$104.00	\$104.00	\$104.00
98 Hex Dog Conversion Kit fits 3' to 4'	050117	.[Finish]	-	\$104.00	-	\$104.00	\$104.00	\$104.00	\$104.00
99 CD Conversion Kit fits 3' to 4'	050115	.[Finish]	-	\$138.00	-	-	\$138.00	\$138.00	\$138.00
98 CD Conversion Kit fits 3' to 4'	050132	.[Finish]	-	\$138.00	-	\$138.00	\$138.00	\$138.00	\$138.00
98 CDSI Kit 3' / 4'	040078/040079	.[Finish]	-	\$458.00	-	\$458.00	\$458.00	\$458.00	\$458.00
98 HDSI Kit 3' / 4'	040080/040081	.[Finish]	-	\$329.00	-	\$329.00	\$329.00	\$329.00	\$329.00
99 CDSI Kit 3' / 4'	040082/040083	.[Finish]	-	\$458.00	-	-	\$458.00	\$458.00	\$458.00
99 HDSI Kit 3' / 4'	040084/040085	.[Finish]	-	\$329.00	-	-	\$329.00	\$329.00	\$329.00
CDSI/HDSI Configuration Pkg	900416	-	\$25.00	-	-	-	-	-	-
99 Fire or Less Dogging Cover Plate Kit fits 3' to 4'	050589	.[Finish]	-	\$62.00	-	-	\$62.00	\$62.00	\$62.00
98 Fire or Less Dogging Cover Plate Kit fits 3' to 4'	050588	.[Finish]	-	\$62.00	-	\$62.00	\$62.00	\$62.00	\$62.00
98 PA-CDSI Cover Plate Kit 3'	47568154	.[Finish]	-	\$129.00	-	\$129.00	\$129.00	\$129.00	\$129.00
98 PA-CDSI Cover Plate Kit 4'	47568155	.[Finish]	-	\$129.00	-	\$129.00	\$129.00	\$129.00	\$129.00
99 PA-CDSI Cover Plate Kit 3'	47568149	.[Finish]	-	\$129.00	-	-	\$129.00	\$129.00	\$129.00
99 PA-CDSI Cover Plate Kit 4'	47568150	.[Finish]	-	\$129.00	-	-	\$129.00	\$129.00	\$129.00
99 ALK Cover Plate Kit fits 3' to 4'	47542458	.[Finish]	-	\$215.00	-	-	\$215.00	\$215.00	\$215.00
98 ALK Cover Plate Kit fits 3' to 4'	47542459	.[Finish]	-	\$215.00	-	\$215.00	\$215.00	\$215.00	\$215.00
CX99 Cover Plate Kit fits 3' to 4'	040093	.[Finish]	-	\$156.00	-	-	\$156.00	\$156.00	\$156.00
CX98 Cover Plate Kit fits 3' to 4'	040094	.[Finish]	-	\$156.00	-	\$156.00	\$156.00	\$156.00	\$156.00
99 CI Kit 3'	050770	.[Finish]	-	\$390.00	-	-	\$390.00	\$390.00	\$390.00
98 CI Kit 3'	050771	.[Finish]	-	\$390.00	-	\$390.00	\$390.00	\$390.00	\$390.00
99 CI Kit 4'	050772	.[Finish]	-	\$390.00	-	-	\$390.00	\$390.00	\$390.00
98 CI Kit 4'	050773	.[Finish]	-	\$390.00	-	\$390.00	\$390.00	\$390.00	\$390.00

For Antimicrobial Finishes add \$15.00 to list. ✓ 630 and 619 finishes available with Series 98 only.

PARTS AND ACCESSORIES

605	606	611	612	613	619	622	625	626	626AM	628	629
US3	US4	US9	US10	US10B	US15	US19	US26	US26D	US26DAM	US28	US32
630	630AM	643e	689	691	693	695	706	710	711	721	728
US32D	US32DAM	-	SP28	SP10	SPBLK	SP313	SP4	313	315	US3A	US4A

COVER PLATE / CONVERSION KITS

Description	Specify		Non-finished	628 710 711	626	✓630	612	606	605 ✓619 625 643e	
	Part number	Finish								
99 DI Kit 3'	050766	.[Finish]	-	\$359.00	-	-	\$359.00	\$359.00	\$359.00	
98 DI Kit 3'	050767	.[Finish]	-	\$359.00	-	\$359.00	\$359.00	\$359.00	\$359.00	
99 DI Kit 4'	050768	.[Finish]	-	\$359.00	-	-	\$359.00	\$359.00	\$359.00	
98 DI Kit 4'	050769	.[Finish]	-	\$359.00	-	\$359.00	\$359.00	\$359.00	\$359.00	
98/9947WDC Conversion Kit - Panic Only	050134	.[Finish]	-	\$496.00	-	\$401.00	\$409.00	\$454.00	\$545.00	
CDSI/HDSI Tumbler Spring Pkg of 10	47380992	-	\$24.00							

For Antimicrobial Finishes add \$15.00 to list. ✓ 630 and 619 finishes available with Series 98 only.

END CAP

Description	Specify		Non-finished	628 710	626	✓630	612	606	605, ✓619, 625, 711, 643e
	Part number	Finish							
98/99 Impact Resistant End Cap Kit	050014	.[Finish]	-	\$115.00	\$128.00	\$142.00	\$142.00	\$130.00	\$130.00
98/99 Impact Resistant End Cap Scr Pkg	900597	.[Finish]	-	\$19.00	\$19.00	\$19.00	\$24.00	\$19.00	\$19.00
98/99 Impact Resistant End Cap Bracket	050524	-	\$17.00	-	-	-	-	-	-

PUSH BAR

Description	Specify		Non-finished	628 710	626	✓630	612	606	605, ✓619, 625, 711, 643e
	Part number	Finish							
98/99 Push Bar Retrofit Kit - 3' Dr*	See Note	.[Finish]	-	\$298.00	\$352.00	\$535.00	\$482.00	\$465.00	\$550.00
98/99 Push Bar Retrofit Kit - 4' Dr*	See Note	.[Finish]	-	\$320.00	\$388.00	\$558.00	\$502.00	\$482.00	\$571.00
98/99 Push Bar Guide Pkg/10	090049	-	\$20.00	-	-	-	-	-	-
98/99 PA Push Bar Retrofit Kit - 3' Dr	PA PBKIT	.[Finish]	-	\$355.00	\$409.00	\$592.00	\$539.00	\$522.00	\$607.00
98/99 PA Push Bar Retrofit Kit - 4' Dr	PA PBKIT	.[Finish]	-	\$377.00	\$445.00	\$615.00	\$559.00	\$539.00	\$628.00

* To order, specify device type, size, finish. Example: PBKIT 99 3' 628

MECHANISM CASE

Description	Specify		Non-finished	628 695	711	626	✓630	612	606	605, 625	✓619,
	Part number	Finish									
99 Series Mechanism Case - 3' Door	968144	.[Finish]	-	\$208.00	\$208.00	-	-	\$258.00	\$258.00	\$294.00	-
99 Series Mechanism Case - 4' Door	968146	.[Finish]	-	\$294.00	\$294.00	-	-	\$339.00	\$339.00	\$384.00	-
98 Series Mechanism Case - 3' Door	970191	.[Finish]	-	\$208.00	\$208.00	-	\$270.00	\$258.00	\$258.00	\$294.00	-
98 Series Mechanism Case - 4' Door	970192	.[Finish]	-	\$294.00	\$294.00	-	\$361.00	\$339.00	\$339.00	\$384.00	-
CD/SS Cylinder Mtg Kit	107813	.[Finish]	-	\$90.00	-	\$86.00	-	\$90.00	\$90.00	\$98.00	\$98.00
CD/SS Cylinder Locating Washer Pkg	050490	-	\$24.00	-	-	-	-	-	-	-	-
CD/SS Mortise Cylinder Collar Pkg	050525	.[Finish]	-	\$62.00	\$78.00	\$62.00	-	\$78.00	\$62.00	\$78.00	\$78.00
CD/SS Cylinder Lock Nut Pkg	050526	-	\$20.00	-	-	-	-	-	-	-	-

For Antimicrobial Finishes add \$15.00 to list. ✓ 630 and 619 finishes available with Series 98 only.

PARTS AND ACCESSORIES

605	606	611	612	613	619	622	625	626	626AM	628	629
US3	US4	US9	US10	US10B	US15	US19	US26	US26D	US26DAM	US28	US32
630	630AM	643e	689	691	693	695	706	710	711	721	728
US32D	US32DAM	-	SP28	SP10	SPBLK	SP313	SP4	313	315	US3A	US4A

MECHANISM CASE

Description	Specify		Non-finished	628 695	711	626	✓630	612	606	605, 625	✓619,
	Part number	Finish									
CD Actuator Pkg/2	090045	-	\$19.00	-	-	-	-	-	-	-	-
CD Dogging Plug Pkg/2	090046	-	\$18.00	-	-	-	-	-	-	-	-
227 Dog Key 5/32" Pkg/10	090085	-	\$101.00	-	-	-	-	-	-	-	-
Mechanism Case Brkt Screw Pkg/10	090073	-	\$17.00	-	-	-	-	-	-	-	-
98/99 Rim/75 98/9927-F Mtg. Pkg.1-3/4"-2-1/4" Dr	900561	-	\$19.00	-	-	-	-	-	-	-	-
98/99 Rim, 98/9927-F Mtg. Pkg. >2-1/4"-2-3/4" Dr	900424	-	\$127.00	-	-	-	-	-	-	-	-
98/99 Rim, 98/9927-F Mtg. Pkg. >2-3/4"-3-1/4" Dr	900425	-	\$127.00	-	-	-	-	-	-	-	-
98/99 Rim, 98/9927-F Mtg. Pkg. >3-1/4"-3-3/4" Dr	900426	-	\$127.00	-	-	-	-	-	-	-	-
98/99 Rim, 98/9927-F Mtg. Pkg. >3-3/4"-4-1/4" Dr	900427	-	\$127.00	-	-	-	-	-	-	-	-
98/9927/27-F Mtg. Pkg. 2-1/4" Door	900568	-	\$19.00	-	-	-	-	-	-	-	-

For Antimicrobial Finishes add \$15.00 to list. ✓ 630 and 619 finishes available with Series 98 only.

BASEPLATE

Description	Specify		Non-finished	605, 606, 612, 625, 628, 643e, 710
	Part number	Finish		
Shock Absorber Pkg	050491	-	\$44.00	-
Baseplate Screw Pkg/10	090037	-	\$18.00	-
Baseplate Bumper Pkg/4	090038	-	\$18.00	-
Baseplate Return Spring Pkg/10	090039	-	\$19.00	-
Hex Dogging Shaft Pkg/2	090040	-	\$19.00	-
Dogging Spring Pkg/2	090041	-	\$18.00	-
Dogging Adapter Spring Pkg/2	090042	-	\$24.00	-
Dogging Adapter Pkg/2	090043	-	\$19.00	-
Dogging Hook Pkg/2	090044	-	\$19.00	-
Baseplate Bearing Strip Pkg/2	090048	-	\$19.00	-
227 Dog Key 5/32" Pkg/2	090005	-	\$30.00	-
227 Dog Key 5/32" Pkg/10	090085	-	\$101.00	-
98/9927-F LBR Latch Spring Pkg/10 (Only for devices manufactured prior to 1995 when converting to LBR)	090088	-	\$31.00	-
CD-CX/SD98/99Rim/27/57 Dogging Hook Screw Pkg/10	47361518	-	\$25.00	-
CD-CX/SD98/9947/48/49/50 Dogging Hook Screw Pkg/10	47361514	-	\$16.00	-
EL Dogging Rod Kit - 3'	050531	-	\$92.00	-
EL Dogging Rod Kit - 4'	050532	-	\$92.00	-
QEL/MEL Motor Cable with 6' Harness	47269206	-	\$84.00	-
EL Potted Circuit Breaker	050534	-	\$483.00	-
EL Dogging Rod Retainer	050538	-	\$21.00	-

PARTS AND ACCESSORIES

605	606	611	612	613	619	622	625	626	626AM	628	629
US3	US4	US9	US10	US10B	US15	US19	US26	US26D	US26DAM	US28	US32
630	630AM	643e	689	691	693	695	706	710	711	721	728
US32D	US32DAM	-	SP28	SP10	SPBLK	SP313	SP4	313	315	US3A	US4A

BASEPLATE

Description	Specify		Non-finished	605, 606, 612, 625, 628, 643e, 710
	Part number	Finish		
EL Receptacle Connector	050539	-	\$20.00	-
EL Female Terminal	050540	-	\$20.00	-
SS Cable	050544	-	\$201.00	-
SS Housing	050545	-	\$670.00	-
EL Cable Assy	110388	-	\$67.00	-
CXA FLD Wiring Cable 10'	114905	-	\$163.00	-
CX99-RCM Kit Less Module	040198	.[Finish]	-	\$381.00
CX98-RCM Kit Less Module	040199	.[Finish]	-	\$381.00
Chexit RX Switch Support Bracket Kit	47899127	-	\$47.00	-
Chexit Wiring Assembly	040191	-	\$290.00	-
Sign 15 Second - Chexit/DE5300	113781	-	\$84.00	-
Sign 30 Second - Chexit/DE5300	113782	-	\$92.00	-

VERTICAL LATCHES

Description	Specify		Non-finished	628	626	629 ✓630	710, 711	606 612	605 ✓619 625 643e
	Part number	Finish							
98/9927/98/9957 Top Latch Retrofit Kit W/SNB*	050091	.[Finish]	-	\$208.00	\$208.00	\$208.00	\$208.00	\$208.00	\$208.00
98/9927/98/9957 Bottom Latch Retrofit Kit W/SNB*	050090	.[Finish]	-	\$208.00	\$208.00	\$208.00	\$208.00	\$208.00	\$208.00
98/9927/98/9957 Top Latch Kit Less Cover	050400	-	\$208.00	-	-	-	-	-	-
98/9927/98/9957 Bottom Latch Kit Less Cover	050401	-	\$208.00	-	-	-	-	-	-
98/9927/98/9957 Pullman Latch Kit Less Cover	050402	-	\$208.00	-	-	-	-	-	-
98/9947 Top Latch Kit	050492	-	\$405.00	-	-	-	-	-	-
98/9947 Bottom Latch Kit	050493	-	\$328.00	-	-	-	-	-	-
ES98/9947 Top Latch Kit	050128	-	\$294.00	-	-	-	-	-	-
98/9948 Top Latch Kit - (non EL)**	050494	-	\$590.00	-	-	-	-	-	-
EL98/9948 Top Latch Kit**	050516	-	\$574.00	-	-	-	-	-	-
98/9948 Bottom Latch Kit**	050495	-	\$633.00	-	-	-	-	-	-
98/9948 Latch Retrofit Kit - (non EL)	050047	-	\$987.00	-	-	-	-	-	-
98/9948-F Latch Retrofit Kit - (non EL)	050048	-	\$987.00	-	-	-	-	-	-
EL98/9948 Latch Retrofit Kit	050522	-	\$1,015.00	-	-	-	-	-	-
EL98/9948-F Latch Retrofit Kit	050523	-	\$1,015.00	-	-	-	-	-	-
98/9927/98/9957/27-F Latch Case Cover Kit	050566	.[Finish]	-	\$78.00	\$98.00	\$114.00	\$78.00	\$90.00	\$104.00
98/9927/98/9957/27-F Latch Cover Screw Pkg.	900850	.[Finish]	-	-	\$19.00	\$19.00	\$19.00	\$19.00	\$19.00
WS98/9927/57/-F Top Latch Case Cover	972754	.[Finish]	-	\$198.00	\$207.00	-	\$198.00	\$198.00	\$203.00
WS98/9927/57/-F Bottom Latch Case Cover	972755	.[Finish]	-	\$198.00	\$207.00	-	\$198.00	\$198.00	\$203.00
98/9927/98/9957 Top Latch Compression Spring Pkg/10	090056	-	\$19.00	-	-	-	-	-	-
98/9927/98/9957 Top Latch Spring Pkg/10	090057	-	\$19.00	-	-	-	-	-	-

* For Devices shipped before October, 1998

**For service replacement only. Refer to Retrofit Kits 050047, 050048, 050522 and 050523 to convert 98/9947 Device to 98/9948.

✓ 630 AND 619 finishes available with Series 98 only.

PARTS AND ACCESSORIES

605	606	611	612	613	619	622	625	626	626AM	628	629
US3	US4	US9	US10	US10B	US15	US19	US26	US26D	US26DAM	US28	US32
630	630AM	643e	689	691	693	695	706	710	711	721	728
US32D	US32DAM	-	SP28	SP10	SPBLK	SP313	SP4	313	315	US3A	US4A

VERTICAL LATCHES

Description	Specify		Non-finished	628	626	629 ✓630	710, 711	606 612	605 ✓619 625 643e
	Part number	Finish							
98/9927/98/9957 Bolt Return Spring Pkg/10	090065	-	\$19.00	-	-	-	-	-	-
98/9927/98/9957 Top Latch Aux. Bolt Spring Pkg/10	090076	-	\$19.00	-	-	-	-	-	-
LBR Fire Latch/Strike Kit	050171	-	\$657.00	-	-	-	-	-	-
98/9927/98/9957-F AFL Strike Hole Plug	050509	-	\$17.00	-	-	-	-	-	-
98/9927/98/9957 Latch Mtg Bracket Kit	050546	-	\$42.00	-	-	-	-	-	-
98/9927/98/9957 Std 1-3/4"-2-1/4" Latch Mtg Pkg/4	900589	-	\$19.00	-	-	-	-	-	-
98/9927/98/9957 Latch Mtg. Pkg/2 for >2-1/4" - 2-3/4" Dr	900521	-	\$127.00	-	-	-	-	-	-
98/9927/98/9957 Latch Mtg. Pkg/2 for >2-3/4" - 3-1/4" Dr	900522	-	\$127.00	-	-	-	-	-	-
98/9927/98/9957 Latch Mtg. Pkg/2 for >3-1/4" - 3-3/4" Dr	900523	-	\$165.00	-	-	-	-	-	-
98/9927/98/9957 Latch Mtg. Pkg/2 for >3-3/4" - 4-1/4" Dr	900524	-	\$165.00	-	-	-	-	-	-
98/9927/98/9957-F LBR Latch Mounting Package	900980	-	\$18.00	-	-	-	-	-	-
WS98/9927 Soffit Release Bracket Package	900241	-	\$44.00	-	-	-	-	-	-
WS98/9927 Latch Mounting Package	900242	.[Finish]	-	-	-	\$43.00	\$43.00	\$43.00	\$43.00
WS98/9927/57/-F Soffit Latch	114141	-	\$292.00	-	-	-	-	-	-
98/9947 Latch Mounting Bracket Kit	109324	-	\$80.00	-	-	-	-	-	-
98/9948 Latch Mounting Bracket Kit**	112868	-	\$90.00	-	-	-	-	-	-
98/9947 Latch Brkt Mtg. Screw (Latch) Pkg/6	090059	-	\$19.00	-	-	-	-	-	-
98/9947 Latch Brkt Mtg. Screw (Door) Pkg/6	090061	-	\$19.00	-	-	-	-	-	-
98/9947/48 Latch Linkage Pin Retaining Ring Pkg/10	090063	-	\$19.00	-	-	-	-	-	-
98/9947 Latch Link Pin Pkg/10	090064	-	\$19.00	-	-	-	-	-	-
98/9947 Bolt Return Spring Pkg/10	090065	-	\$19.00	-	-	-	-	-	-
98/9947 Top Latch Compression Spring Pkg/10	090066	-	\$18.00	-	-	-	-	-	-
98/9947WDC/WDC-F Auxiliary Mtg. Package	900856	-	\$19.00	-	-	-	-	-	-
98/9947WDC Offset Link Pkg	900871	-	\$19.00	-	-	-	-	-	-
98/9927 RG/Latch Mtg. Pkg 2-1/4" - 2-3/4"	900527	.[Finish]	-	-	\$149.00	-	\$149.00	\$181.00	-
98/9927 RG/Latch Mtg. Pkg 2-3/4" - 3-1/4"	900528	.[Finish]	-	-	\$149.00	-	\$149.00	\$181.00	-
98/9927 RG/Latch Mtg. Pkg 3-1/4" - 3-3/4"	900529	.[Finish]	-	-	\$181.00	-	\$181.00	\$211.00	-
98/9927 RG/Latch Mtg. Pkg 3-3/4" - 4-1/4"	900530	.[Finish]	-	-	\$181.00	-	\$181.00	\$211.00	-
WS98/9927 Bottom Latch Assy Kit	048002	-	\$267.00	-	-	-	-	-	-
WS98/9927 Top Latch Assy Kit	048003	-	\$368.00	-	-	-	-	-	-

* For Devices shipped before October, 1998

**For service replacement only. Refer to Retrofit Kits 050047, 050048, 050522 and 050523 to convert 98/9947 Device to 98/9948.

✓ 630 AND 619 finishes available with Series 98 only.

PARTS AND ACCESSORIES

605	606	611	612	613	619	622	625	626	626AM	628	629
US3	US4	US9	US10	US10B	US15	US19	US26	US26D	US26DAM	US28	US32
630	630AM	643e	689	691	693	695	706	710	711	721	728
US32D	US32DAM	-	SP28	SPI0	SPBLK	SP313	SP4	313	315	US3A	US4A

VERTICAL RODS												
Description	Specify		Non-finished	628	626	✓630	710	711	612	606	605	✓619
	Part number	Finish									625 643e	
9927/9957 Top Rod Kit	050512	.[Finish]	-	\$112.00	-	-	\$132.00	\$153.00	\$153.00	\$153.00	\$153.00	-
9827/9857 Top Rod Kit	050513	.[Finish]	-	\$112.00	-	-	\$132.00	\$153.00	\$153.00	\$153.00	\$153.00	\$153.00
WS98/9927 Top Rod	101025	.[Finish]	-	-	-	\$233.00	\$233.00	\$233.00	\$233.00	\$494.00	\$494.00	\$494.00
WS 98/9957 Top Rod Assy Kit	048000	.[Finish]	-	-	-	\$267.00	\$267.00	\$267.00	-	\$452.00	\$717.00	\$267.00
9927/9957 Bottom Rod Kit	050514	.[Finish]	-	\$112.00	-	-	\$132.00	\$153.00	\$153.00	\$153.00	\$153.00	-
9827/9857 Bottom Rod Kit	050515	.[Finish]	-	\$112.00	-	-	\$132.00	\$153.00	\$153.00	\$153.00	\$153.00	\$153.00
WS98/9927 Bottom Rod	101026	.[Finish]	-	-	-	\$233.00	\$233.00	\$233.00	\$233.00	\$494.00	\$494.00	\$494.00
WS 98/9957 Bottom Rod Assy Kit	048001	.[Finish]	-	-	-	\$267.00	\$267.00	\$267.00	-	\$452.00	\$717.00	\$267.00
98/9947/48 Adj. Top Rod Kit - 6'8"-8'4" Dr	050574	-	\$132.00	-	-	-	-	-	-	-	-	-
98/9947/48 Bottom Rod Kit	050575	-	\$132.00	-	-	-	-	-	-	-	-	-
98/9947WDC Top Rod - 6'8"-8'4" Dr	050582	-	\$228.00	-	-	-	-	-	-	-	-	-
98/9947WDC Bottom Rod	050583	-	\$228.00	-	-	-	-	-	-	-	-	-
9927/9957 One Piece Top Rod Kit - 8'	050650	.[Finish]	-	\$333.00	\$333.00	-	\$333.00	\$333.00	\$211.00	\$168.00	\$333.00	-
9927/9957 One Piece Top Rod Kit - 10'	050651	.[Finish]	-	\$367.00	\$367.00	-	\$367.00	\$360.00	\$233.00	\$203.00	\$360.00	-
9927/9957 One Piece Top Rod Kit - 12'	050652	.[Finish]	-	\$390.00	\$390.00	-	\$390.00	\$405.00	\$257.00	\$239.00	\$405.00	-
9827/9857 One Piece Top Rod Kit - 8'	050653	.[Finish]	-	\$333.00	\$333.00	\$333.00	\$333.00	\$333.00	\$211.00	\$168.00	\$333.00	\$333.00
9827/9857 One Piece Top Rod Kit - 10'	050654	.[Finish]	-	\$367.00	\$367.00	\$367.00	\$367.00	\$360.00	\$233.00	\$203.00	\$360.00	\$360.00
9827/9857 One Piece Top Rod Kit - 12'	050655	.[Finish]	-	\$390.00	\$390.00	\$405.00	\$390.00	\$405.00	\$257.00	\$239.00	\$405.00	\$405.00
9927/9957 Extension Rod 36" Kit	051802	.[Finish]	-	\$42.00	\$42.00	-	\$42.00	\$42.00	\$42.00	\$42.00	\$42.00	-
9827/9857 Extension Rod 36" Kit	051810	.[Finish]	-	\$42.00	\$42.00	\$42.00	\$42.00	\$42.00	\$42.00	\$42.00	\$42.00	\$42.00
9927/9957 Extension Rod 60" Kit	050642	.[Finish]	-	\$193.00	\$193.00	-	\$193.00	\$373.00	\$355.00	\$237.00	\$373.00	-
9827/9857 Extension Rod 60" Kit	050644	.[Finish]	-	\$193.00	\$193.00	\$199.00	\$199.00	\$390.00	\$369.00	\$242.00	\$390.00	\$199.00
WS98/9927/57 Extension Rod 12" Kit	051812	.[Finish]	-	-	-	\$42.00	\$42.00	\$42.00	\$42.00	\$42.00	\$42.00	\$42.00
98/9947/48 Extension Rod Kit - Adj 8'4"-10'	051808	-	\$42.00	-	-	-	-	-	-	-	-	-
98/9947/48 Extension Rod Kit - Adj 10'-11'8"	050622	-	\$137.00	-	-	-	-	-	-	-	-	-
98/9947/48 Extension Rod Kit - Adj 11'8"-13'4"	050623	-	\$153.00	-	-	-	-	-	-	-	-	-
98/9947/48 Extension Rod Kit - Adj 13'4"-15'	050624	-	\$153.00	-	-	-	-	-	-	-	-	-
98/9927/98/9957-F Rod Guide Assembly	112063	.[Finish]	-	\$76.00	\$76.00	\$90.00	\$76.00	\$85.00	\$118.00	\$118.00	\$180.00	\$180.00
98/9927/98/9957-F Rod Guide Mtg. Package	900919	.[Finish]	-	-	\$19.00	\$19.00	\$19.00	\$22.00	\$19.00	\$19.00	\$19.00	\$19.00
WS98/9927/57/-F Rod Guide Kit	050482	.[Finish]	-	-	\$112.00	-	\$112.00	\$112.00	\$115.00	\$109.00	\$115.00	-
98/9927/98/9957 Rod Roll Pin Pkg/10	090054	-	\$20.00	-	-	-	-	-	-	-	-	-
33A/35A/98/9947/48-F Rod Pin Kit	900246	-	\$12.00	-	-	-	-	-	-	-	-	-
98/9927/98/9957 Rod Connector-Latch Pkg/2	090067	-	\$30.00	-	-	-	-	-	-	-	-	-

* For Devices shipped after July, 1997.

✓ 630 and 619 finishes available with Series 98 only.

PARTS AND ACCESSORIES

605	606	611	612	613	619	622	625	626	626AM	628	629
US3	US4	US9	US10	US10B	US15	US19	US26	US26D	US26DAM	US28	US32
630	630AM	643e	689	691	693	695	706	710	711	721	728
US32D	US32DAM	-	SP28	SP10	SPBLK	SP313	SP4	313	315	US3A	US4A

VERTICAL RODS

Description	Specify		Non-finished	628	626	✓630	710	711	612	606	605 625 643e	✓619
	Part number	Finish										
98/9927/98/9957 Rod Connector-C/ Case Pkg/2	090068	-	\$30.00	-	-	-	-	-	-	-	-	-
98/9927/98/9957 Top or Bottom Rod Connector	050547	-	\$17.00	-	-	-	-	-	-	-	-	-
* 98/9947 Rod Connecting Screw Pkg/2	090071	-	\$24.00	-	-	-	-	-	-	-	-	-
98/9948 Rod Connecting Screw Pkg/2	090072	-	\$24.00	-	-	-	-	-	-	-	-	-
98/9927/98/9957 Rod Extension Connector Pkg/4	090075	-	\$20.00	-	-	-	-	-	-	-	-	-
98/9947 Ratchet Release Kit	106222	.[Finish]	-	\$196.00	-	\$196.00	\$196.00	\$196.00	\$196.00	\$196.00	-	-
98/9947 Ratchet Release Spacer 1/8"	970978	.[Finish]	-	\$31.00	-	\$31.00	\$31.00	-	\$31.00	\$31.00	-	-
98/9947 Ratchet Lever Spring Pkg/2	090069	-	\$18.00	-	-	-	-	-	-	-	-	-
98/9947 Ratchet Release Screw Pkg/2	090070	-	\$24.00	-	-	-	-	-	-	-	-	-
98/9947 Rod Adjusting Package	900620	-	\$31.00	-	-	-	-	-	-	-	-	-
98/9947 Adjusting Screw LBR Package	900898	-	\$19.00	-	-	-	-	-	-	-	-	-
98/9947 1/2" Insulclad Kit	051841	-	\$374.00	-	-	-	-	-	-	-	-	-
98/9947 1/4" Insulclad Kit	051842	-	\$227.00	-	-	-	-	-	-	-	-	-

* For Devices shipped after July, 1997.

✓ 630 and 619 finishes available with Series 98 only.

QUIET MECHANICAL RETROFIT KITS

	Specify	Price each
QM RIM Device Kit (98/99, 33A/35A)	47259560	\$266.00
QM SVR Device Kit (98/9927, 3327A/3527A)	47263418	\$266.00
QM 996 -R/V trim Kit	47260610	\$308.00
Damper Assembly, 996	47259557	\$89.00

DOUBLE CYLINDER (OLD STYLE)

	Specify	Price each
Lock / Unlock label only	971220-00	\$17.00

PNEUMATIC ACCESSORIES

	Specify	Price each
PNT-1 - Pneumatic power transfer	012014-36	\$914.00
PN connector - PN adapter kit - 5/32" to 1/4" LCN tubing	051827-00	\$55.00
PN 5/32" tubing - 25' length	051828-00	\$36.00
PN 5/32" tubing - 50' length	051823-00	\$47.00
PN 5/32" tubing - 100' length	051824-00	\$80.00
PN 5/32" tubing - 200' length	051825-00	\$151.00

PARTS AND ACCESSORIES

605	606	611	612	613	619	622	625	626	626AM	628	629
US3	US4	US9	US10	US10B	US15	US19	US26	US26D	US26DAM	US28	US32
630	630AM	643e	689	691	693	695	706	710	711	721	728
US32D	US32DAM	-	SP28	SP10	SPBLK	SP313	SP4	313	315	US3A	US4A

98/9949 Series

VERTICAL LATCHES	Specify	Price each
49 Top Latch Assembly	24090110	\$366.00
49 Bottom Latch Assembly	24090128	\$394.00

CENTERSLIDE KITS	Specify	Price each
98/9949 Centerslide Kit	24090144	\$562.00

STRIKE/ASSY KIT	Specify	Price each
98/9949 Strike/Assy Kit - Contains 249 & 349 strike, ctr slide mtg pkg and device mtg pkg	051875	\$83.00
98/9949 LBL Strike/Assy Kit - Contains 249 strike, ctr slide mtg pkg and device mtg pkg	051876	\$66.00
98/9949 LBL- AFL Strike/Assy Kit - Contains 249 strike, AUX LBR pkg, ctrl slide mtg pkg and device mtg pkg	051880	\$119.00

49 CABLE*	Specify	Price each	
Top Cable Assembly	Door Opening Heights 6'0" to 6'10"	47250398	\$318.00
Top Cable Assembly	Door Opening Heights 6'10" to 8'0"	47250175	\$318.00
Top Cable Assembly	Door Opening Heights >8'0" to 9'2"	47250176	\$318.00
Top Cable Assembly	Door Opening Heights >9'2" to 10'4"	47250177	\$318.00
Bottom Cable Assembly	Door Opening Heights 6'0" to 6'10"	47250403	\$318.00
Bottom Cable Assembly	Door Opening Heights 6'10" to 8'0"	47250178	\$318.00
Bottom Cable Assembly	Door Opening Heights >8'0" to 9'2"	47250179	\$318.00
Bottom Cable Assembly	Door Opening Heights >9'2" to 10'4"	47250180	\$318.00
Replacement Cable Kit (10' core wire, end fitting, and sizing templates)	47250968	\$132.00	

For door opening heights more than 10', consult factory.
 Consult customer support for non-standard center lines or if a threshold is installed.
 * For Complete 49 Cable System kits, see page 106.

MOUNTING PACKAGES	Specify	Price each
49 Bottom Mounting Package	23946437	\$100.00
49 Top Mounting Package	23946429	\$70.00
98/9949 HM/AL Centerslide Mounting	23946445	\$44.00

MISC.	Specify	Price each
Cable Removal Tool - qty 1	24052979	\$22.00
Cable Removal Tool - Pkg/10	24090706	\$168.00
338 Filler Plate	24230914	\$127.00
Spacer Block Kit 3/4" undercut	24231516	\$43.00

PARTS AND ACCESSORIES

605	606	611	612	613	619	622	625	626	626AM	628	629
US3	US4	US9	US10	US10B	US15	US19	US26	US26D	US26DAM	US28	US32
630	630AM	643e	689	691	693	695	706	710	711	721	728
US32D	US32DAM	-	SP28	SP10	SPBLK	SP313	SP4	313	315	US3A	US4A

98/9950WDC Series

VERTICAL LATCHES	Specify	Price each
Top Latch Kit with mounting pack	48968820	\$515.00
Bottom Latch Kit with mounting pack	48968838	\$430.00

CENTERSLIDE KITS	Specify	Price each
9950WDC Centerslide kit with mounting pack	48973291	\$842.00

FIRE KITS	Specify	Price each
98/9950WDC-F Fire Kit (fire barrier, intumescent for scalp plate and barrier, mounting packs)	48968861	\$340.00

MOUNTING KIT	Specify	Price each
Top, Bottom, and centerslide Mounting Pkg	24685505	\$44.00
Top Latch Mounting Kit	49000409	\$19.00
Bottom Latch Mounting Kit	49000391	\$19.00

CABLES	Specify	Price each
Top Cable 6'8"-7'0" WDC	24648180	\$78.00
Top Cable 7'1"-8'0" WDC	24647273	\$78.00
Top Cable 8'1"-9'0" WDC	24647281	\$88.00
Top Cable 9'1"-10'0" WDC	24647299	\$88.00
Bottom Cable WDC	24647265	\$78.00

FIRE PIN KIT	Specify	Price each
50WDC Fire pin Kit (current fire pin , fire pin sleeve, fire pin strike)	48968887	\$233.00

LIFT FINGER KIT	Specify	Price each
98/9950WDC Finger Kit	47258386	\$101.00
98/9950WDC Lift Finger Retrofit Kit	47260629	\$211.00
SD WDC Finger Kit	47244842	\$127.00

XP98/XP99 SERIES

605	606	611	612	613	619	622	625	626	626AM	628	629
US3	US4	US9	US10	US10B	US15	US19	US26	US26D	US26DAM	US28	US32
630	630AM	643e	689	691	693	695	706	710	711	721	728
US32D	US32DAM	-	SP28	SP10	SPBLK	SP313	SP4	313	315	US3A	US4A

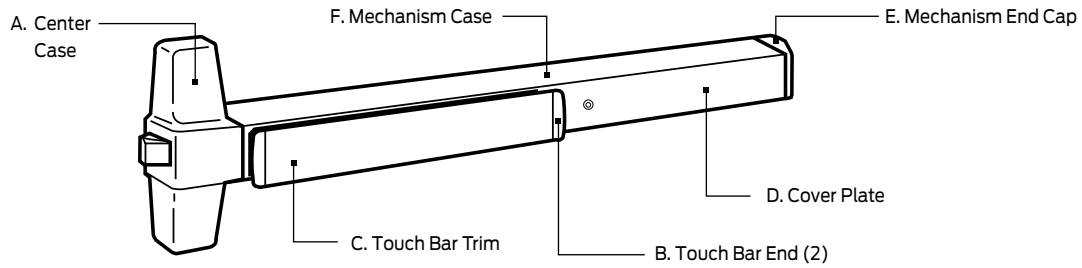

STANDARD FINISHES					
COLOR	US NUMBER	BHMA NUMBER	A, B, E	C - TOUCH BAR TRIM FINISHES	D, F
Bright Brass	US3	605	Bright Brass	Bright Brass US3, 605	Buffed Anodized
Satin Brass	US4	606	Satin Brass	Satin Brass US4, 606	Anodized
Satin Bronze	US10	612	Plated/Anodized	Satin Bronze US10, 725	Anodized
Satin Nickel	US15	619	Plated, Clear Powder Coat	Satin Stainless Steel US32D, 630	Anodized
Polished Chrome	US26	625	Plated	Bright Stainless Steel US32, 629	Buffed Anodized
Satin Chrome	US26D	626	Powder Coat	Satin Stainless Steel US32D, 630	Anodized
Anodized Aluminum	US28	628	Powder Coat	Satin Stainless Steel US32D, 630	Anodized
Satin Stainless Steel	US32D	630	Stainless Steel	Satin Stainless Steel US32D, 630	Anodized
Duranodic Dark Bronze	313	710	Powder Coat	Powder Coat 313, 710	Powder Coat
Black	315	711	Powder Coat	Powder Coat 315, 711	Powder Coat

Note: 619: Satin Nickel (US15) XP98 Series only.

SPECIAL FINISHES					
COLOR	US NUMBER	BHMA NUMBER	A, B, E	C - TOUCH BAR TRIM FINISHES	D, F
Bright Bronze	US9	611	Plated	Bright Bronze US9, 611	Buffed Anodized
Satin Bronze, Oil-Rubbed	US10B	613	Oil-Rubbed	Oil-Rubbed, US10B	Powder Coat
Satin Chrome, Antimicrobial	US26D-AM	626-AM	AM Clear over Chrome	AM Clear over Satin Stainless Steel US32D, 630	AM Clear over Anodized
Satin Stainless Steel, Antimicrobial	US32D-AM	630-AM	AM Clear over Stainless Steel	AM Clear over Satin Stainless Steel US32D, 630	AM Clear over Anodized
Powder Coat	RAL # *	--	Powder Coat	Satin Stainless Steel US32D, 630 (unless specified to match device)	Powder Coat

* See Finish page for optional RAL color information.

FINISH NOTES: 619 and 630 finishes available on Series XP98 only. Devices ordered in 628 and 630 will be supplied with Trims in 626.

XP98 / XP99 SERIES SEX BOLT QUANTITIES		
APPLICATION	425 SEX BOLT (OPTIONAL)	825 SEX BOLT (SUPPLIED)
DT, EO, NL, TP, K or L Device with trim	2	
99 NLOP Device with 110MD/WD	6	
99 EO Device (exit device only)	6	
99-F Wood Door with trim		2

 Indicates products that have EPD documentation available and meet LEED v4.

XP98/XP99 SERIES

605	606	611	612	613	619	622	625	626	626AM	628	629
US3	US4	US9	US10	US10B	US15	US19	US26	US26D	US26DAM	US28	US32
630	630AM	643e	689	691	693	695	706	710	711	721	728
US32D	US32DAM	-	SP28	SP10	SPBLK	SP313	SP4	313	315	US3A	US4A

TYPE OF DEVICE

XP98 or XP99
Rim

FUNCTION

DT: Dummy Trim	EO: Exit Only	K: Knob	KBE: Knob Blank Escutcheon
KDT: Knob Dummy	KNL: Knob Night Latch	L: Lever, 06 Standard	LBE (Lever-Blank Escutcheon)
LDT: Lever, Dummy Trim	LNL: Lever-Night Latch	LKC: Lever, Key Capture	NL: Night Latch, Key Retracts
NLOP: Night Latch, Opt. Pull	TP: Thumbpiece	TPBE: Thumbpiece - Blank Escutcheon	

RATING

None: Panic Exit Device - F: Fire Exit Device

DOUBLE CYLINDER

-2: Double Cylinder

DEVICE FINISH

605: Bright Brass (US3)	606: Satin Brass (US4)	611: Bright Bronze (US9)	612: Satin Bronze (US10)
613: Satin Bronze-Oil Rubbed (US10B)	625: Bright Chrome (US26)	626: Satin Chrome (US26D)	626AM: Antimicrobial (US26D-AM)
628: Anodized Aluminum (US28)	710: Duranodic Dark Bronze (313)	711: Black (315)	643e: Aged Bronze

Note: 619: Satin Nickel (US15) XP98 Series only.

DEVICE LENGTH (FEET AND INCHES)

3': 3' Device for 2' 4" - 3' Door 4': 4' Device for 2' 10" - 4' Door

DEVICE HANDING







RHR: Right Hand Reverse LHR: Left Hand Reverse

TRIM OPTIONS

LT: Less Trim	110MD / 110WD: Standard on NL-OP	392-7: Optional Pull Dummy Trim	696 / 696WDF: Optional Lever Trim
697 / 697WDF: Optional Lever Trim	VR910: Vandal Resistant	990: Standard Rim	996: Standard. Lever Trim

M996: Motorized 996

CONTROL LEVER STYLES 06 LEVER STANDARD

Standard levers:	01	02	03	05	06	07	12	16	17	18
	ACC: Accent 	AST: Asti 	MER: Merano 	LAT: Latitude	LON: Longitude					
Knurled levers:	03K	06K	M81K							
M Collection lever:	M51	M52	M53	M54	M55	M56	M61 	M63 		
	M81	M82	M83	M84	M85 	ME1	ME2	ME3		
Stainless steel levers:	03SS	06SS	17SS	LATSS	LONSS	M57	M62 			

XP98/XP99 SERIES

605	606	611	612	613	619	622	625	626	626AM	628	629
US3	US4	US9	US10	US10B	US15	US19	US26	US26D	US26DAM	US28	US32
630	630AM	643e	689	691	693	695	706	710	711	721	728
US32D	US32DAM	-	SP28	SP10	SPBLK	SP313	SP4	313	315	US3A	US4A

TRIM FINISH

605: Bright Brass (US3)	606: Satin Brass (US4)	612: Satin Bronze (US10)	613: Satin Bronze-Oil Rubbed (US10B)
619: Satin Nickel (US15)	625: Bright Chrome (US26)	626: Satin Chrome (US26D)	693: Painted Black (SPBLK)
710: Duranodic Dark Bronze (313)			

DOGGING OPTIONS

CD: Cylinder Dogging, Panic Only	CDSI: Cylinder Dogging with Indicator	CI: Cylinder Dogging Indicator	DI: Dogging Indicator
HDSI: Hex Dogging with Indicator	LD: Less Dogging	SD: Special Dogging	

SWITCH OPTIONS

LXLC: LBM Low Current	LXRXC: LBM Request to Exit Low Current	RX: Request to Exit	RX2: Request to Exit Double Switch
RXLC: Request to Exit Low Current	WPRX: Waterproof Request to Exit		

LATCH RETRACTION OPTIONS - PANIC ONLY

EL: Electric Latch Retraction	QEL: Quiet Electric Latch Retraction
-------------------------------	--------------------------------------

CX DELAYED EGRESS

CX: Chexit - Controlled Exit	CXRCM: Remote Chexit Module
------------------------------	-----------------------------

STORM RATING

HH: Wind and Impact - Hurricane Rated	HW: Wind Only - Hurricane Rated
---------------------------------------	---------------------------------

ACCESSIBLE DEVICE

AX: Accessible device compliant with the California Building Code (Section 11B-309.4) requirement for 5 lb. maximum operational force.

STRIKE SERIES

LS: Less Strike	909: Standard Panic and Fire	954: Optional mullion
-----------------	------------------------------	-----------------------

STRIKE FINISH

622: Matte Black (US19)

TOUCH BAR TRIM OPTIONS

BR: Braille	EMB: Embossed "Push"	KN: Knurled	RSS: Emergency Exit (630 only)
SG: Safety Glow			

DRAINAGE / WEEP HOLES

WH: Drainage/Weep Holes in Mechanism Case (3' device will have 4 holes, 6" spacing; 4' device will have 6 holes, 6" spacing)

CX DELAYED EGRESS RELEASE DELAY

15SEC: 15 second delay	BOCA15SEC: BOCA 15 second delay	M15SEC: 15 second mute delay	OSEC: 0 second delay
30SEC: 30 second delay	BOCA30SEC: BOCA 30 second delay	INFDEL: Infinite delay	2-60 Seconds: 2 second intervals

XP98/XP99 SERIES

605	606	611	612	613	619	622	625	626	626AM	628	629
US3	US4	US9	US10	US10B	US15	US19	US26	US26D	US26DAM	US28	US32
630	630AM	643e	689	691	693	695	706	710	711	721	728
US32D	US32DAM	-	SP28	SP10	SPBLK	SP313	SP4	313	315	US3A	US4A

TOUCH BAR FINISH

605: Bright Brass (US3)	606: Satin Brass (US4)	612: Satin Bronze (US10)	613: Satin Bronze-Oil Rubbed (US10B)
622: Matte Black (US19)	629: Bright Stainless (US32)	630AM: Satin Stainless (US32D-AM)	630: Satin Stainless (US32D)
695: Duranodic Dark Bronze (313)			

MISC DEVICE OPTIONS

ALK: Standard Alarm Kit	CYL: Include Cylinder	SNB: Include # of Sex Bolts
-------------------------	-----------------------	-----------------------------

CONNECTOR

CON: Connectors

SLM BLOCKING

SLM: SLM Blocking

SECURITY SCREWS

SEC: Include Security Screws

GBK/SHIM KIT/RISES

GBK: Include GBK

DOOR MATERIAL

ALD: Aluminum door	CP: Composite door	HMD: Hollow metal	WD: Wood door
--------------------	--------------------	-------------------	---------------

DOOR THICKNESS

DT1-3/4: 1-3/4" Standard	DT2: 2" thickness	DT2-1/4: 2-1/4" thickness
--------------------------	-------------------	---------------------------

DOOR APPLICATION

DE: Pair Double egress doors with mullion	PR: Pair of doors with mullion	SGL: Single door
---	--------------------------------	------------------

XP98/XP99 SERIES

605	606	611	612	613	619	622	625	626	626AM	628	629
US3	US4	US9	US10	US10B	US15	US19	US26	US26D	US26DAM	US28	US32
630	630AM	643e	689	691	693	695	706	710	711	721	728
US32D	US32DAM	-	SP28	SPI0	SPBLK	SP313	SP4	313	315	US3A	US4A

Rim devices

ACN							PRICE BASED ON FINISH							Default trim, included				
Device type	Function	Fire	Finish	Device size	Handing	Lever design	626	628	630 ¹	710	612	606 ²	605 ²		619 ¹	625	711	613 ²
							643E	711	613 ²									
EXIT HARDWARE							3' DEVICE PRICING SHOWN. 4' ADD \$26.00 LIST.											
XP[98/99]	EO	.	[]	[]			\$2,147	\$1,950	\$2,204	\$2,060	\$2,204	\$2,272	\$2,517	\$3,063	\$2,528		N/A	
XP[98/99]	DT	.	[]	[]			\$2,509	\$2,312	\$2,566	\$2,438	\$2,582	\$2,563	\$2,911	\$3,441	\$2,906		990DT	
XP[98/99]	NL	.	[]	[]	[]		\$2,530	\$2,333	\$2,587	\$2,459	\$2,603	\$2,584	\$2,932	\$3,462	\$2,927		990NL-R/V	
XP[98/99]	NL-OP	.	[]	[]			\$2,335	\$2,138	\$2,392	\$2,248	\$2,392	\$2,445	\$2,705	\$3,251	\$2,716		110MD/WD	
XP[98/99]	TP	.	[]	[]			\$2,665	\$2,468	\$2,722	\$2,592	\$2,722	\$2,703	\$3,074	\$3,595	\$3,060		990TP-R/V	
XP[98/99]	TP-BE	.	[]	[]			\$2,665	\$2,468	\$2,722	\$2,592	\$2,722	\$2,703	\$3,074	\$3,595	\$3,060		990TP-BE-R/V	
XP[98/99]	K	.	[]	[]			\$2,783	\$2,586	\$2,840	\$2,696	\$2,925	\$2,807	\$3,286	\$3,699	\$3,164		996K-R/V	
XP[98/99]	K-BE	.	[]	[]			\$2,783	\$2,586	\$2,840	\$2,696	\$2,925	\$2,807	\$3,286	\$3,699	\$3,164		996K-BE-R/V	
XP[98/99]	K-DT	.	[]	[]			\$2,769	\$2,572	\$2,826	\$2,682	\$2,911	\$2,793	\$3,272	\$3,685	\$3,150		996K-DT-R/V	
XP[98/99]	K-NL	.	[]	[]			\$2,769	\$2,572	\$2,826	\$2,682	\$2,911	\$2,793	\$3,272	\$3,685	\$3,150		996K-NL-R/V	
XP[98/99]	L	.	[]	[]	[]	[]	\$2,975	\$2,778	\$3,032	\$2,888	\$3,105	\$3,058	\$3,454	\$3,891	\$3,386		996L-R/V	
XP[98/99]	L-BE	.	[]	[]	[]	[]	\$2,975	\$2,778	\$3,032	\$2,888	\$3,105	\$3,058	\$3,454	\$3,891	\$3,386		996L-BE-R/V	
XP[98/99]	L-DT	.	[]	[]	[]	[]	\$2,807	\$2,610	\$2,864	\$2,720	\$2,937	\$2,890	\$3,286	\$3,723	\$3,218		996L-DT-R/V	
XP[98/99]	L-NL	.	[]	[]	[]	[]	\$2,807	\$2,610	\$2,864	\$2,720	\$2,937	\$2,890	\$3,286	\$3,723	\$3,218		996L-NL-R/V	
XP[98/99]	L-KC	.	[]	[]	[]	[]	\$2,975	\$2,778	\$3,032	\$2,888	\$3,105	\$3,058	\$3,454	\$3,891	\$3,386		996L-KC-R/V	
FIRE EXIT HARDWARE							3' DEVICE PRICING SHOWN. 4' ADD \$26.00 LIST.											
XP[98/99]	EO	F	[]	[]			\$2,417	\$2,220	\$2,474	\$2,330	\$2,474	\$2,542	\$2,787	\$3,333	\$2,798		N/A	
XP[98/99]	DT	F	[]	[]			\$2,779	\$2,582	\$2,836	\$2,708	\$2,852	\$2,833	\$3,181	\$3,711	\$3,176		990DT	
XP[98/99]	NL	F	[]	[]	[]		\$2,800	\$2,603	\$2,857	\$2,729	\$2,873	\$2,854	\$3,202	\$3,732	\$3,197		990NL-R/V	
XP[98/99]	NL-OP	F	[]	[]			\$2,605	\$2,408	\$2,662	\$2,518	\$2,662	\$2,715	\$2,975	\$3,521	\$2,986		110MD/WD	
XP[98/99]	TP	F	[]	[]			\$2,935	\$2,738	\$2,992	\$2,862	\$2,992	\$2,973	\$3,344	\$3,865	\$3,330		990TP-R/V	
XP[98/99]	TP-BE	F	[]	[]			\$2,935	\$2,738	\$2,992	\$2,862	\$2,992	\$2,973	\$3,344	\$3,865	\$3,330		990TP-BE-R/V	
XP[98/99]	K	F	[]	[]			\$3,053	\$2,856	\$3,110	\$2,966	\$3,195	\$3,077	\$3,556	\$3,969	\$3,434		996K-R/V	
XP[98/99]	K-BE	F	[]	[]			\$3,053	\$2,856	\$3,110	\$2,966	\$3,195	\$3,077	\$3,556	\$3,969	\$3,434		996K-BE-R/V	
XP[98/99]	K-NL	F	[]	[]			\$3,039	\$2,842	\$3,096	\$2,952	\$3,181	\$3,063	\$3,542	\$3,955	\$3,420		996K-NL-R/V	
XP[98/99]	L	F	[]	[]	[]	[]	\$3,245	\$3,048	\$3,302	\$3,158	\$3,375	\$3,328	\$3,724	\$4,161	\$3,656		996L-R/V	
XP[98/99]	L-BE	F	[]	[]	[]	[]	\$3,245	\$3,048	\$3,302	\$3,158	\$3,375	\$3,328	\$3,724	\$4,161	\$3,656		996L-BE-R/V	
XP[98/99]	L-NL	F	[]	[]	[]	[]	\$3,077	\$2,880	\$3,134	\$2,990	\$3,207	\$3,160	\$3,556	\$3,993	\$3,488		996L-NL-R/V	
XP[98/99]	L-KC	F	[]	[]	[]	[]	\$3,245	\$3,048	\$3,302	\$3,158	\$3,375	\$3,328	\$3,724	\$4,161	\$3,656		996L-KC-R/V	

² Consult factory for lead time.

¹ 630 and 619 finishes available only on 98 Series.

² 613 finish has 710 finish device with 613 parts.

DEFAULT ATTRIBUTES

Pricing includes default options shown below. Additional options and configurations available.

Cylinders:	Sex bolts	Door thickness	Center line
Not included	Not included	1-3/4"	39-13/16"

Strike(s):

Exit hardware:

- Includes 909 strike

Fire exit hardware:

- Single door applications: Includes 909 strike
- Double door applications: 954 strike will be supplied at an additional \$150.00 list add

OPTIONS

605	606	611	612	613	619	622	625	626	626AM	628	629
US3	US4	US9	US10	US10B	US15	US19	US26	US26D	US26DAM	US28	US32
630	630AM	643e	689	691	693	695	706	710	711	721	728
US32D	US32DAM	-	SP28	SP10	SPBLK	SP313	SP4	313	315	US3A	US4A

ANTIMICROBIAL COATING - Available in 626 (US26D) and 630 (US32D), use suffix "AM" when ordering. 630AM (US32D-AM) available only on 98 Series devices. Example: 626AM	Specify (Suffix)	Price adjustment
For device with or without trim	AM	\$97.00
For trim only (626AM)	AM	\$45.00

CYLINDER DOGGING - Not for use with fire exit hardware	Specify (Prefix)	Price adjustment
Standard baseplate cylinder dogging	CD	\$138.00
Cylinder dogging indicator ¹	CI	\$382.00
Cylinder dogging with indicator	CDSI	\$458.00
Dogging indicator	DI	\$359.00
Hex dogging with indicator	HDSI	\$329.00
Less dogging	LD	\$0.00
Special dogging - panic only ²	SD	\$586.00

¹ Not available with EL/QEL electrical option.

² Available on panic devices only. May be used with EL option. Specify handing.

TRIM CYLINDER LOCKDOWN	Specify (Suffix)	Price adjustment
Double Cylinder ¹	-2	\$478.00

¹ Available with L and LBE functions only. Specify handing. Rim cylinder sold separately. Keyed rim cylinder (20-021) or thumbturn rim cylinders (XB11-979, XB13-379) are available from Schlage.

WARNING: Double cylinder option (-2) is ideal for fire exit hardware and panic hardware that is not equipped with the dogging feature. Combining a double cylinder option with the dogging feature is not recommended, as the hardware could be in the dogged (unlatched) position when the outside trim indicates a locked position.

SWITCHES - Available on all 98/99 Series devices	Specify (Prefix)	Price adjustment
	Prefix for configured device	
Request to Exit	RX	\$365.00
Request to Exit Low Current	RX-LC	\$424.00
Request to Exit Double Switch	RX-2	\$455.00
RX to RX-2 Conversion (order part number 050271)	RX-AUX	\$380.00
Waterproof Request to Exit	WP-RX	\$529.00
Latch Bolt Monitoring Low Current ¹	LX-LC	\$424.00
Request to Exit / Latch Bolt Monitoring combination Low Current	LX-RX-LC	\$665.00

¹ The LX-LC switch is factory installed only.

See page 179-180 for field-installed switch kit part numbers.

LATCH RETRACTION - See 98/99 product catalog for required accessory equipment	Specify (Prefix)	Price adjustment
Electric latch retraction	EL	\$1,337.00
Electric Latch Retraction with Special Center Case Dogging ¹ (Available with "EL" option)	SD-EL	\$1,923.00
Quiet electric latch retraction	QEL	\$1,258.00
Quiet electric latch retraction with hex dogging (panic only)	HD-QEL	\$1,258.00
Quiet Electric Latch Retraction with Special Center Case Dogging ¹ (Available with "QEL" option)	SD-QEL	\$1,844.00
Quiet electric latch retraction for AX devices	QELX	\$1,338.00
Quiet electric latch retraction with hex dogging (panic only) for AX devices	HD-QELX	\$1,338.00

¹ Available only on XP98/99 rim panic devices. Specify handing.

OPTIONS

605	606	611	612	613	619	622	625	626	626AM	628	629
US3	US4	US9	US10	US10B	US15	US19	US26	US26D	US26DAM	US28	US32
630	630AM	643e	689	691	693	695	706	710	711	721	728
US32D	US32DAM	-	SP28	SP10	SPBLK	SP313	SP4	313	315	US3A	US4A

CHEXIT - Available on all XP98/99 Series devices	Specify (Prefix)			Price adjustment
	Prefix	Finish	Release delay	
Chexit – Controlled exit device (15 second delay furnished standard) <ul style="list-style-type: none"> Chexit is not available with any electrical options (EL, QEL, PN) Chexit is not available with any switches (RX, RXLC, RX2, WP-RX, LX, LXLC, LXR, LXRXL, SS) 	CXA	-	.[Release delay]	\$2,667.00
Remote Chexit module	RCM	.[Finish]	.[Release delay]	\$382.00
Chexit 10' cable	CXCAB	-	-	

RELEASE DELAY	Specify	Price adjustment
0 Second Delay	0 Delay	\$194.00
30 Second Delay ¹	30 Delay ¹	\$194.00
15 second delay with BOCA Modification	BOCA-15 Delay ²	\$194.00
30 second delay with BOCA Modification ¹	BOCA-30 Delay ¹ ²	\$194.00
2-60 Seconds in 2 Second Intervals or infinite delay ¹	Other Delays ¹ ²	\$263.00

15 second Module sold separately, specify part number 040086.

¹ Over 15 second delay requires a letter of approval from the authority having local jurisdiction over the premises prior to the installation of the device. Allegion cannot grant such approval nor does it warrant local jurisdiction compliance.

² Consult factory for lead time.

EXIT ALARM	Specify	Price adjustment
Exit alarm <ul style="list-style-type: none"> Price includes RX switch; can substitute with LXLC switch at no additional charge To order Less Switch, deduct \$365.00 list 9 volt battery included 	ALK	\$907.00

ELECTRIC UNLOCKING	Specify (Prefix)	Price adjustment
Motor Driven Electric Unlocking of outside M996 Trim - for 98/99 rim, mortise, surface vertical and concealed vertical devices. Available with L or LBE functions only. Specify handing. Dual voltage - works with either 12 or 24 VDC power supplies, furnished Fail Safe (FS) but can be converted in the field with dip switch without mechanical conversion. See page 146 for pricing and optional lever designs.	M996	\$916.00

STORM RATING

HURRICANE DEVICE - USE WITH APPROVED ALLEGION DOOR APPLICATIONS

Specify HH (Wind and Impact) or HW (Wind-Only) prefix when ordering devices or mullions for hurricane applications. If application is unknown, specify HH which will satisfy the requirements for both applications. HH option only available for select series and models. HH/HW devices will be furnished with strikes shown in charts (and with through bolts if HH product) and are price-adjusted as indicated. Mullions priced separately.

HH (WIND AND IMPACT)

Model	Door mode	Mullion	Standard strike	Specify (Prefix)	Price adjustment
XP98/99 Rim	SGL	-	909	HH	\$114.00
XP98/99 Rim	PR	HH9954	909	HH	\$114.00
XP98-F/99-F Rim	SGL	-	909	HH	\$114.00
XP98-F/99-F Rim	PR	HH9954	954	HH	\$264.00

HW (WIND ONLY)

Model	Door mode	Mullion	Standard strike	Specify (Prefix)	Price adjustment
XP98/99 Rim	SGL	-	909	HW	\$0.00
XP98/99 Rim	PR	4954XP or KR4954XP	909	HW	\$0.00

OPTIONS

605	606	611	612	613	619	622	625	626	626AM	628	629
US3	US4	US9	US10	US10B	US15	US19	US26	US26D	US26DAM	US28	US32
630	630AM	643e	689	691	693	695	706	710	711	721	728
US32D	US32DAM	-	SP28	SP10	SPBLK	SP313	SP4	313	315	US3A	US4A

STORM RATING

HURRICANE DEVICE - USE WITH APPROVED ALLEGION DOOR APPLICATIONS

Specify HH (Wind and Impact) or HW (Wind-Only) prefix when ordering devices or mullions for hurricane applications. If application is unknown, specify HH which will satisfy the requirements for both applications. HH option only available for select series and models. HH/HW devices will be furnished with strikes shown in charts (and with through bolts if HH product) and are price-adjusted as indicated. Mullions priced separately.

HW (WIND ONLY)

Model	Door mode	Mullion	Standard strike	Specify (Prefix)	Price adjustment
XP98-F/99-F Rim	SGL	-	909	HW	\$0.00
XP98-F/99-F Rim	PR	9954XP or KR9954XP	954	HW	\$150.00

ACCESSIBLE DEVICE

	Specify (Prefix)	Price adjustment
<ul style="list-style-type: none"> Accessible device compliant with the California Building Code (Section 11B-309.4) requirement for 5 lb. maximum operational force. EL and QELX options available Not available with CX 	AX	\$89.00

TOUCHBAR OPTIONS

	Specify		Price adjustment
	Suffix	Handing	
Vision impaired touchpad, raised letters and braille, 630 finish. Standard reads "Caution Stairwell." Optional up to 20 alpha / numeric characters on single line, consult factory.	BRaille	.[RHR, LHR]	\$180.00
Brass, bronze and stainless touchbar trims embossed "PUSH". No additional charge when specified with device.	EMB	.[RHR, LHR]	\$0.00
Red silk-screened lettered touchbar trims (standard on SS devices). "Emergency Exit Only, Push to Open and Sound Alarm" No additional charge when specified with device.	RSS	.[RHR, LHR]	\$0.00
Knurled touchpad. No additional charge when specified with device.	KN	-	\$0.00
Safety glow feature for 3' device	SG	-	\$652.00
Safety glow feature for 4' device	SG	-	\$678.00

Custom graphics available on touchbar trim. See page 7 for details.

WEEP HOLES

	Specify	Price adjustment
Drainage (weep) holes in mechanism case. 3' device will have 4 holes - 6" spacing, 4' device will have 6 holes	WH	\$128.00

CONNECTORS

	Specify	Price adjustment
Cross-category solution using interconnect components for electrified options. Available with ALK, LXLC, RX, RXLC, and WPRX switches.	CON	\$0.00

NON-STANDARD DOOR THICKNESS

Door thickness > 2-1/4" - <= 4-1/4"	Specify	Price adjustment
XP98/99 Rim devices EO (exit only no trim) with sex bolts	.DT[]	\$128.00
XP98/99 Rim devices NL-OP (with 110NL cylinder control) with sex bolts	.DT[]	\$256.00
XP98/99 Rim devices NL-OP (with 110NL cylinder control) NO sex bolts	.DT[]	\$128.00

KITS

605	606	611	612	613	619	622	625	626	626AM	628	629
US3	US4	US9	US10	US10B	US15	US19	US26	US26D	US26DAM	US28	US32
630	630AM	643e	689	691	693	695	706	710	711	721	728
US32D	US32DAM	-	SP28	SP10	SPBLK	SP313	SP4	313	315	US3A	US4A

EL CONVERSION KITS - Field conversion kits for Electric Latch Retraction	Specify				Price each
	Standard		Allegion Connect -CON		
	3' device	4' device	3' device	4' device	
EL baseplate conversion kit	050070	050078	050853	050854	\$1,555.00

QEL CONVERSION KITS - Field conversion kits for Quiet Electric Latch Retraction	Specify				Price each
	Standard		Allegion Connect -CON		
	3' device	4' device	3' device	4' device	
Baseplate conversion kits (may be used for ANY conversion application)					
QEL baseplate conversion kit	958003	040065	040063	040066	\$1,323.00
HD-QEL baseplate conversion kit (hex dogging included, panic only)	958004	040067	040064	040068	\$1,323.00
QELX baseplate conversion kit for AX devices	041166	041167	041168	041169	\$1,402.00
HD-QELX Baseplate Conversion Kit for AX devices (hex dogging included, panic only)	041170	041171	041172	041173	\$1,402.00
Modular conversion kits (for non-EL panic devices, for non-EL fire-rated devices sold after October 2014, or for replacing existing motor)					
QEL modular conversion kit	114317	114317	040061	040061	\$1,258.00
HD-QEL modular conversion kit (hex dogging included, panic only)	958002	958002	040062	040062	\$1,258.00
QELX modular conversion kit for AX devices	041162	041162	041163	041163	\$1,338.00
HD-QELX modular conversion kit for AX devices (hex dogging Included, panic only)	041164	041164	041165	041165	\$1,338.00

ESL (EMERGENCY SECURE LOCKDOWN) KITS	Specify			Price each
	3' device	4' device	Finish	
98 ESL Kit - Retrofit kit for QEL 98 devices; Panic or Fire (not available in 619 or 630)	967244	967245	.[Finish]	\$586.00
99 ESL Kit - Retrofit kit for QEL 99, devices; Panic or Fire	967246	967247	.[Finish]	\$586.00

- No WS
- No mechanical dogging of QEL (SD-QEL, HD-QEL)
- Unit requires a standard 1 1/4" (32mm) mortise cylinder with an inverted straight cam and compression ring and spring. Kit does not come with cylinder or thumbturn, must be ordered separately. Examples: Schlage conventional cylinder: 20-001 1 1/4" XQ11-949; Schlage thumbturn cylinder: 09-904 1 1/4" B502-191 XQ11-949; Schlage ADA thumbturn cylinder: 09-904 1 1/4" XB11-720 B502-191 XQ11-949
- Install in alignment with 2018 IBC 1010.2.8 NFPA 101 14.2.2.2.4 or per local AHJ - Only allowed with trim functions: NL, K-NL, L-NL, NL-OP, T-NL

XP98/99 -2 CONVERSION AND CENTER CASE COVER KITS												
Description	Specify						628	626	630	612	606	605
	Part number	Double cylinder	Device type	Fire	Finish	Handing	710					619
XP98/99-2 Conversion Kit ¹	2SIKIT	-.2	.[XP98 or XP99]	.[F]	.[Finish]	.[Handing]	\$1,561.00	\$1,642.00	\$1,708.00	\$1,708.00	\$1,642.00	\$1,561.00
XP98/99-2 Center Case Cover Kit	CC-CVR	-.2	.[XP98 or XP99]	-	.[Finish]	.[Handing]	\$264.00	\$307.00	\$345.00	\$307.00	\$307.00	\$264.00

¹ XP98/99-2 Conversion Kits include components for updating 996 and 994 lever trims.

CX OPTIONS	Specify		Price each
	Part number	Finish	
RCM KIT-98 Less Module	040199	.[Finish]	\$381.00
RCM KIT-99 Less Module	040198	.[Finish]	\$381.00

Note: 15 second Module sold separately. Specify part number 040086.

PARTS AND ACCESSORIES

605	606	611	612	613	619	622	625	626	626AM	628	629
US3	US4	US9	US10	US10B	US15	US19	US26	US26D	US26DAM	US28	US32
630	630AM	643e	689	691	693	695	706	710	711	721	728
US32D	US32DAM	-	SP28	SP10	SPBLK	SP313	SP4	313	315	US3A	US4A

DOUBLE CYLINDER MODULE SERVICE KIT	Specify		622, 605, 606, 612, 625, 626, 689, 695
	Part number	Finish	
-2 XP Module Service Kit	47448785	[Finish]	\$166.00

ELECTRICAL UNLOCKING RETROFIT KITS	Specify	Price each
996 R/V/C Conversion to M996 Motorized Kit	47273111	\$998.00
996 Mort Conversion to M996 Motorized Kit	47273112	\$1,040.00

CENTER CASE									
Description	Specify		Non-finished	628	626	630	612	606	605
	Part number	Finish		710 711					✓619 625
XP98/99R Center Case Kit Less Cover	050689	-	\$719.00	-	-	-	-	-	-
XP98/99R/-F Center Case Kit Less Cover	050690	-	\$746.00	-	-	-	-	-	-
XP98/99/-F Center Case Cover Kit	050691	[Finish]	-	\$203.00	\$293.00	\$308.00	\$293.00	\$293.00	\$337.00
XP98/99/-F Center Case Cover Bracket	050692	-	\$41.00	-	-	-	-	-	-

RETROFIT KITS									
Description	Specify		Non-finished	628	626	630	612	606	605
	Part number	Finish		710 711					✓619 625
XP99-909 - 98/99 Series Device conversion to XP with 909 strike	050676	[Finish]	-	\$1,346.00	\$1,393.00	\$1,445.00	\$1,384.00	\$1,384.00	\$1,534.00
XP99-954 - 98/99 Series Device conversion to XP with 954 strike	050675	[Finish]	-	\$1,497.00	\$1,543.00	\$1,594.00	\$1,534.00	\$1,534.00	\$1,655.00
XP98/99 Retrofit Kit Mounting Package	900297	-	\$32.00	-	-	-	-	-	-

MOUNTING PACKAGES			
Description	Specify		Non-finished
	Part number	Finish	
XP98/99 Rim Mtg. Pkg for >2-1/4" - 2-3/4" Dr	900424	-	\$127.00
XP98/99 Rim Mtg. Pkg for >2-3/4" - 3-1/4" Dr	900425	-	\$127.00
XP98/99 Rim Mtg. Pkg for >3-1/4" - 3-3/4" Dr	900426	-	\$127.00
XP98/99 Rim Mtg. Pkg for >3-3/4" - 4-1/4" Dr	900427	-	\$127.00

✓619 finishes available with XP98 only.

94/95 INPACT SERIES

605	606	611	612	613	619	622	625	626	626AM	628	629
US3	US4	US9	US10	US10B	US15	US19	US26	US26D	US26DAM	US28	US32
630	630AM	643e	689	691	693	695	706	710	711	721	728
US32D	US32DAM	-	SP28	SP10	SPBLK	SP313	SP4	313	315	US3A	US4A

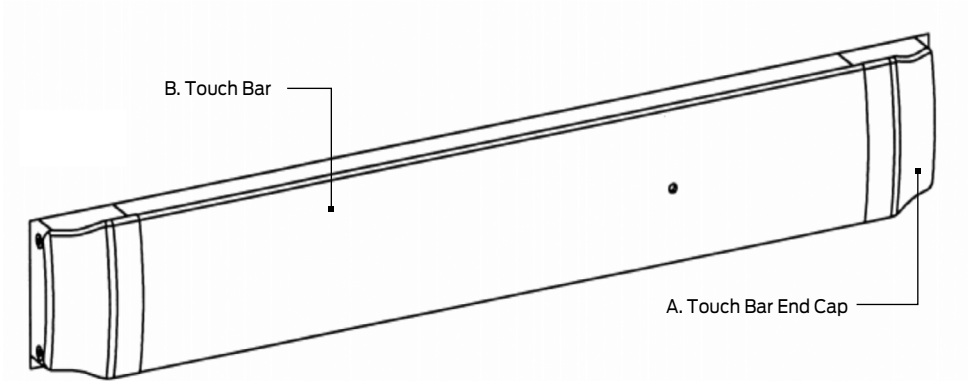

STANDARD FINISHES				
COLOR	US NUMBER	BHMA NUMBER	A	B -TOUCH BAR FINISHES*
Bright Brass	US3	605	Powder Coat - Black 315, 622	Bright Brass US3
Satin Brass	US4	606	Powder Coat - Black 315, 622	Satin Brass US4
Satin Bronze	US10	612	Powder Coat - Black 315, 622	Satin Bronze US10
Polished Chrome	US26	625	Powder Coat - Black 315, 622	Bright Stainless Steel US32
Satin Chrome	US26D	626	Powder Coat - Black 315, 622	Satin Stainless Steel US32D
Anodized Aluminum	US28	628	Powder Coat - Black 315, 622	Satin Stainless Steel US32D
Duranodic Dark Bronze	313	710	Powder Coat - Black 315, 622	Powder Coat 313, 710
Satin Chrome, Antimicrobial	US26D-AM	626-AM	AM Clear over 622	AM Clear over Anodized

* Anodized Equivalent
No Sex Bolts are needed for the 94/95 Series device.

95/95 INPACT SERIES

605	606	611	612	613	619	622	625	626	626AM	628	629
US3	US4	US9	US10	US10B	US15	US19	US26	US26D	US26DAM	US28	US32
630	630AM	643e	689	691	693	695	706	710	711	721	728
US32D	US32DAM	-	SP28	SP10	SPBLK	SP313	SP4	313	315	US3A	US4A

TYPE OF DEVICE		
94/9547 Concealed Vertical Rod	94/9548 Concealed Vertical Rod	94/9575 Mortise Lock

FUNCTION			
DT: Dummy Trim	EO: Exit Only	L: Lever, 06 Standard	LBE: Lever-Blank Escutcheon
LDT: Lever, Dummy Trim	NL: Night Latch, Key Retracts	TL: Turn Lever	TLBE: Turn Lever - Blank Escutcheon
TLOP: Turn Lever, Optional Pull			

RATING	
None: Panic Exit Device	- F: Fire Exit Device

DEVICE FINISH			
605: Bright Brass (US3)	606: Satin Brass (US4)	612: Satin Bronze (US10)	625: Bright Chrome (US26)
626: Satin Chrome (US26D)	626AM: Antimicrobial (US26D-AM)	628: Anodized Aluminum (US28)	710: Duranodic Dark Bronze (313)

DEVICE HANDING	
RHR: Right Hand Reverse	LHR: Left Hand Reverse

TRIM / CONTROL OPTIONS			
LC: Less Control	LT: Less Trim	376T: Thumbturn Control - CV	392-7: Opt. Wire Pull Trim
550: Optional Offset Dummy Trim		940L: Lever Control	

CONTROL LEVER STYLES 06 LEVER STANDARD										
Standard levers:	01	02	03*	05	06*	07*	12*	16	17*	18
	ACC: Accent 🗎		AST: Asti 🗎		MER: Merano 🗎		LAT: Latitude		LON: Longitude	
Knurled levers:	03K	06K	M81K							
M Collection lever:	M51	M52	M53	M54	M55	M56	M61 🗎	M63 🗎		
	M81	M82	M83	M84	M85 🗎	ME1	ME2	ME3		
Stainless steel levers:	03SS	06SS	17SS	LATSS	LONSS	M57	M62 🗎			

*Trim lever styles.

TRIM / CONTROL FINISH			
605: Bright Brass (US3)	606: Satin Brass (US4)	612: Satin Bronze (US10)	613: Satin Bronze-Oil Rubbed (US10B)
622: Matte Black (US19)	625: Bright Chrome (US26)	626: Satin Chrome (US26D)	628: Anodized Aluminum (US28)
693: Painted Black (SPBLK)	695: Painted Dark Bronze (SP313)	626AM: Antimicrobial (US26D-AM)	

MORTISE LOCK		
LL: Less Lock	7500IN: Standard Mortise	SS7500IN: Signal Switch

95/95 INPACT SERIES

605	606	611	612	613	619	622	625	626	626AM	628	629
US3	US4	US9	US10	US10B	US15	US19	US26	US26D	US26DAM	US28	US32
630	630AM	643e	689	691	693	695	706	710	711	721	728
US32D	US32DAM	-	SP28	SP10	SPBLK	SP313	SP4	313	315	US3A	US4A

MORTISE LOCK FINISH			
605: Bright Brass (US3)	606: Satin Brass (US4)	612: Satin Bronze (US10)	613: Satin Bronze-Oil Rubbed (US10B)
622: Matte Black (US19)	629: Bright Stainless (US32)	630: Satin Stainless (US32D)	689: Sprayed Aluminum (SP28)

RODS FOR SURFACE / CONCEALED VERTICAL DEVICES ONLY	
LBR: Less Bottom Rod	LBRAFL: LBR with Auxiliary Fire Pin

SWITCH OPTIONS
LX: Latch Bolt Monitoring

LATCH RETRACTION OPTIONS
QEL: Quiet Electric Latch Retraction

STORM RATING
HW: Wind Only - Hurricane Rated

ACCESSIBLE DEVICE
AX: Accessible device compliant with the California Building Code (Section 11B-309.4) requirement for 5 lb. maximum operational force.

STRIKE SERIES			
LS: Less Strike	LTS: Less Top Strike	575: Standard Mortise	575-2: Optional Mortise
576A/576B: Optional Mortise	338: Standard Concealed Vertical Rod		

BOTTOM STRIKE SERIES		
LBS: Less Bottom Strike	304L: Mortise	385A: Adjustable Mortise

STRIKE FINISH			
605: Bright Brass (US3)	606: Satin Brass (US4)	612: Satin Bronze (US10)	613: Satin Bronze-Oil Rubbed (US10B)
622: Matte Black (US19)	629: Bright Stainless (US32)	630: Satin Stainless (US32D)	MD: e-Moly

DEVICE OPTIONS	
CYL: Include Cylinder	PL: Pullman Latch w/ES Strike

DOOR / FRAME MATERIAL
HMD: Hollow Metal

DOOR THICKNESS
DT1-3/4: 1-3/4" Standard

DOOR APPLICATION		
DE: Pair Double egress doors	PR: Pair of doors	SGL: Single door

94/95 INPACT SERIES

605	606	611	612	613	619	622	625	626	626AM	628	629
US3	US4	US9	US10	US10B	US15	US19	US26	US26D	US26DAM	US28	US32
630	630AM	643e	689	691	693	695	706	710	711	721	728
US32D	US32DAM	-	SP28	SP10	SPBLK	SP313	SP4	313	315	US3A	US4A

Concealed vertical rod devices (47)

ACN							PRICE BASED ON FINISH							Default trim, Included
Device type	Function	Fire	Finish	Device size	Handing	Lever design	626	628	710 ¹	612	606	605 625	711	
EXIT HARDWARE							3' AND 4' DEVICE PRICING SHOWN.							
[94/95]47	EO	.	[] . []	.			\$2,449	\$2,309	\$2,364	\$2,476	\$2,587	\$2,788	\$3,213	N/A
[94/95]47	DT	.	[] . []	.			\$3,241	\$3,101	\$3,156	\$3,277	\$3,213	\$3,602	\$4,027	550DT
[94/95]47	L	.	[] . []	[] . []			\$3,416	\$3,276	\$3,361	\$3,516	\$3,512	\$3,864	\$4,180	940L
[94/95]47	L-BE	.	[] . []	[] . []			\$3,416	\$3,276	\$3,361	\$3,516	\$3,512	\$3,864	\$4,180	940L-BE
[94/95]47	L-DT	.	[] . []	[] . []			\$3,527	\$3,387	\$3,472	\$3,627	\$3,623	\$3,975	\$4,291	940L-DT
[94/95]47	TL	.	[] . []				\$4,287	\$4,147	\$4,202	\$4,403	\$4,114	\$4,728	\$5,073	550DT/376T
[94/95]47	TL-BE	.	[] . []				\$4,230	\$4,090	\$4,145	\$4,346	\$4,057	\$4,671	\$5,016	550DT/376T-BE
FIRE EXIT HARDWARE							3' AND 4' DEVICE PRICING SHOWN.							
[94/95]47	EO	F	[] . []				\$2,856	\$2,716	\$2,771	\$2,883	\$2,994	\$3,195	\$3,620	N/A
[94/95]47	DT	F	[] . []				\$3,648	\$3,508	\$3,563	\$3,684	\$3,620	\$4,009	\$4,434	550DT
[94/95]47	L	F	[] . []	[] . []			\$3,823	\$3,683	\$3,768	\$3,923	\$3,919	\$4,271	\$4,587	940L
[94/95]47	L-BE	F	[] . []	[] . []			\$3,823	\$3,683	\$3,768	\$3,923	\$3,919	\$4,271	\$4,587	940L-BE
[94/95]47	TL	F	[] . []				\$4,694	\$4,554	\$4,609	\$4,810	\$4,521	\$5,135	\$5,480	550DT/376T
[94/95]47	TL-BE	F	[] . []				\$4,637	\$4,497	\$4,552	\$4,753	\$4,464	\$5,078	\$5,423	550DT/376T-BE

¹ Devices in 710 finish are furnished with 695 trims by default

DEFAULT ATTRIBUTES

Pricing includes default options shown below. Additional options and configurations available.

Cylinders:	Sex bolts	Door thickness	Center line
Not included	Not included	1-3/4"	39-13/16"

Strike(s):

Exit hardware:

- Includes 338 and 385 strikes

Fire exit hardware:

- Includes 338 and 385A strikes

94/95 INPACT SERIES

605	606	611	612	613	619	622	625	626	626AM	628	629
US3	US4	US9	US10	US10B	US15	US19	US26	US26D	US26DAM	US28	US32
630	630AM	643e	689	691	693	695	706	710	711	721	728
US32D	US32DAM	-	SP28	SP10	SPBLK	SP313	SP4	313	315	US3A	US4A

Concealed vertical rod devices (48)

ACN							PRICE BASED ON FINISH							Default trim, Included
Device type	Function	Fire	Finish	Device size	Handing	Lever design	626	628	710 ¹	612	606	605 625	711	
EXIT HARDWARE							3' AND 4' DEVICE PRICING SHOWN.							
[94/95]48 .	EO .	[] .	[] .				\$2,802	\$2,662	\$2,717	\$2,829	\$2,940	\$3,141	\$3,566	N/A
[94/95]48 .	DT .	[] .	[] .				\$3,594	\$3,454	\$3,509	\$3,630	\$3,566	\$3,955	\$4,380	550DT
[94/95]48 .	L .	[] .	[] .	[] .	[] .		\$3,769	\$3,629	\$3,714	\$3,869	\$3,865	\$4,217	\$4,533	940L
[94/95]48 .	L-BE .	[] .	[] .	[] .	[] .		\$3,769	\$3,629	\$3,714	\$3,869	\$3,865	\$4,217	\$4,533	940L-BE
[94/95]48 .	L-DT .	[] .	[] .	[] .	[] .		\$3,880	\$3,740	\$3,825	\$3,980	\$3,976	\$4,328	\$4,644	940L-DT
[94/95]48 .	TL .	[] .	[] .				\$4,640	\$4,500	\$4,555	\$4,756	\$4,467	\$5,081	\$5,426	550DT/376T
[94/95]48 .	TL-BE .	[] .	[] .				\$4,583	\$4,443	\$4,498	\$4,699	\$4,410	\$5,024	\$5,369	550DT/376T-BE
FIRE EXIT HARDWARE							3' AND 4' DEVICE PRICING SHOWN.							
[94/95]48 .	EO .	F .	[] .	[] .			\$3,211	\$3,071	\$3,126	\$3,238	\$3,349	\$3,550	\$3,975	N/A
[94/95]48 .	DT .	F .	[] .	[] .			\$4,003	\$3,863	\$3,918	\$4,039	\$3,975	\$4,364	\$4,789	550DT
[94/95]48 .	L .	F .	[] .	[] .	[] .	[] .	\$4,178	\$4,038	\$4,123	\$4,278	\$4,274	\$4,626	\$4,942	940L
[94/95]48 .	L-BE .	F .	[] .	[] .	[] .	[] .	\$4,178	\$4,038	\$4,123	\$4,278	\$4,274	\$4,626	\$4,942	940L-BE
[94/95]48 .	TL .	F .	[] .	[] .			\$5,049	\$4,909	\$4,964	\$5,165	\$4,876	\$5,490	\$5,835	550DT/376T
[94/95]48 .	TL-BE .	F .	[] .	[] .			\$4,992	\$4,852	\$4,907	\$5,108	\$4,819	\$5,433	\$5,778	550DT/376T-BE

¹ Devices in 710 finish are furnished with 695 trims by default

DEFAULT ATTRIBUTES

Pricing includes default options shown below. Additional options and configurations available.

Cylinders:	Sex bolts	Door thickness	Center line
Not included	Not included	1-3/4"	39-13/16"

Strike(s):

Exit hardware:

- Includes 338 and 385 strikes

Fire exit hardware:

- Includes 338 and 385A strikes

94/95 INPACT SERIES

605	606	611	612	613	619	622	625	626	626AM	628	629
US3	US4	US9	US10	US10B	US15	US19	US26	US26D	US26DAM	US28	US32
630	630AM	643e	689	691	693	695	706	710	711	721	728
US32D	US32DAM	-	SP28	SP10	SPBLK	SP313	SP4	313	315	US3A	US4A

Mortise lock devices (75)

ACN							PRICE BASED ON FINISH							Default trim, Included
Device type	Function	Fire	Finish	Device size	Handing	Lever design	626	628	710 ¹	612	606	605 625	711	
EXIT HARDWARE							3' AND 4' DEVICE PRICING SHOWN.							
[94/95]75	EO	.	[]	[]	.		\$2,971	\$2,831	\$2,917	\$3,029	\$3,140	\$3,341	\$3,766	N/A
[94/95]75	DT	.	[]	[]	.		\$3,763	\$3,623	\$3,709	\$3,830	\$3,766	\$4,155	\$4,580	550DT
[94/95]75	NL	.	[]	[]	[]	[]	\$3,763	\$3,623	\$3,709	\$3,830	\$3,766	\$4,155	\$4,580	550DT
[94/95]75	L	.	[]	[]	[]	[]	\$3,938	\$3,798	\$3,914	\$4,069	\$4,065	\$4,417	\$4,733	940L
[94/95]75	L-BE	.	[]	[]	[]	[]	\$3,938	\$3,798	\$3,914	\$4,069	\$4,065	\$4,417	\$4,733	940L-BE
[94/95]75	L-DT	.	[]	[]	[]	[]	\$4,049	\$3,909	\$4,025	\$4,180	\$4,176	\$4,528	\$4,844	940L-DT
FIRE EXIT HARDWARE							3' AND 4' DEVICE PRICING SHOWN.							
[94/95]75	EO	F	[]	[]	.		\$3,403	\$3,263	\$3,349	\$3,461	\$3,572	\$3,773	\$4,198	N/A
[94/95]75	DT	F	[]	[]	.		\$4,195	\$4,055	\$4,141	\$4,262	\$4,198	\$4,587	\$5,012	550DT
[94/95]75	NL	F	[]	[]	[]	[]	\$4,195	\$4,055	\$4,141	\$4,262	\$4,198	\$4,587	\$5,012	550DT
[94/95]75	L	F	[]	[]	[]	[]	\$4,370	\$4,230	\$4,346	\$4,501	\$4,497	\$4,849	\$5,165	940L
[94/95]75	L-BE	F	[]	[]	[]	[]	\$4,370	\$4,230	\$4,346	\$4,501	\$4,497	\$4,849	\$5,165	940L-BE

¹ Devices in 710 finish are furnished with 695 trims by default

DEFAULT ATTRIBUTES

Pricing includes default options shown below. Additional options and configurations available.

Cylinders:	Sex bolts	Door thickness	Center line
Not included	Not included	1-3/4"	39-13/16"

Strike(s):

- Exit hardware:
 - Includes 575 strike
- Fire exit hardware:
 - Includes 575 strike

OPTIONS

605	606	611	612	613	619	622	625	626	626AM	628	629
US3	US4	US9	US10	US10B	US15	US19	US26	US26D	US26DAM	US28	US32
630	630AM	643e	689	691	693	695	706	710	711	721	728
US32D	US32DAM	-	SP28	SP10	SPBLK	SP313	SP4	313	315	US3A	US4A

DEVICE LENGTH	Specify (Prefix)	Price adjustment
2' 6" up to 2' 9.7/8" Door	2' 6" up to 2' 9.7/8" Door	\$198.00

LESS BOTTOM ROD (LBR/LBL Fire-Rated Devices must be ordered in pairs, and one Auxiliary Fire Pin (AFL) is furnished per pair.)	Specify (Suffix)	Price adjustment
94/9547-F LBR	LBR	\$0.00
94/9547 LBR	LBR	-\$179.00

ANTIMICROBIAL COATING - Available in 626 (US26D) and 630 (US32D), use suffix "AM" when ordering. Example: 626AM	Specify (Suffix)	Price adjustment
For device with or without trim	AM	\$97.00
For trim only (626AM)	AM	\$45.00

SWITCHES - Available on all 94/95 Series devices	Specify (Prefix)	Price adjustment
Latch Bolt Monitoring	LX	\$365.00
Signal Switch - for 94/9575 mortise devices (includes SS7500IN lock), specify handing	SS	\$365.00

LATCH RETRACTION - See 94/95 product catalog for required accessory equipment	Specify (Prefix)	Price adjustment
Quiet electric latch retraction	QEL	\$1,258.00

STORM RATING

HURRICANE DEVICE - USE WITH APPROVED ALLEGION DOOR APPLICATIONS

Specify HH (Wind and Impact) or HW (Wind-Only) prefix when ordering devices or mullions for hurricane applications. If application is unknown, specify HH which will satisfy the requirements for both applications. HH option only available for select series and models. HH/HW devices will be furnished with strikes shown in charts (and with through bolts if HH product) and are price-adjusted as indicated. Mullions priced separately.

HW (WIND-ONLY)

Model	Door mode	Standard strike	Specify (Prefix)	Price adjustment
9447/9547	SGL or PR	Top: 338 Bottom: 304L	HW	-\$97.00
9447-F/9547-F	PR	Top: 338 Bottom: 304L	HW	-\$97.00
9475/9575	SGL	575	HW	\$0.00
9475-F/9575-F	SGL	575	HW	\$0.00

ACCESSIBLE DEVICE	Specify (Prefix)	Price adjustment
<ul style="list-style-type: none"> Accessible device compliant with the California Building Code (Section 11B-309.4) requirement for 5 lb. maximum operational force Available on AX94/9547 and AX94/9547-F Trim functions available EO, DT, NL, L, LBE, LDT and LNL 	AX	\$89.00

KITS

QEL CONVERSION KITS - Field conversion kits for Quiet Electric Latch Retraction	Specify	Price each
Modular conversion kits (for non-EL panic devices, for non-EL fire-rated devices sold after October 2014, or for replacing existing motor)	Standard	
	3' or 4' device	
QEL modular conversion kit	958005-00	\$1,258.00

LBR KIT	Specify	Price each
Fire Pin Kit, complete auxiliary bolt field replacement kit	051860-32	\$216.00

PARTS AND ACCESSORIES

605	606	611	612	613	619	622	625	626	626AM	628	629
US3	US4	US9	US10	US10B	US15	US19	US26	US26D	US26DAM	US28	US32
630	630AM	643e	689	691	693	695	706	710	711	721	728
US32D	US32DAM	-	SP28	SP10	SPBLK	SP313	SP4	313	315	US3A	US4A

CENTER CASE

Description	Specify		Non-finished	622	628	626	710	612	606	605 625
	Part number	Finish								
94/9547/48/75 Center Case	CASE.107	-	\$338.00	-	-	-	-	-	-	-
Control Link Pin Kit (w/Retaining Ring)	050585	-	\$18.00	-	-	-	-	-	-	-
Retaining Ring Pkg/10	090107	-	\$19.00	-	-	-	-	-	-	-
Main Control Link	971712	-	\$24.00	-	-	-	-	-	-	-

MECHANISM CASE

Description	Specify		Non-finished	622	628	626	710	612	606	605 625
	Part number	Finish								
94/9547/48/75 End Cap Package	ECAP.115	.[Finish]	-	\$138.00	-	-	-	-	-	-
INPACT Device Mounting Package	PKGMTG.1001	-	\$45.00	-	-	-	-	-	-	-
9547/48/75-F Pushpad	971655	.[Finish]	-	-	-	-	-	-	-	\$461.00
9447/48/75-F Pushpad	971656	.[Finish]	-	-	-	-	-	-	-	\$461.00
Dogging Clip	971659	-	\$54.00	-	-	-	-	-	-	-
Dogging Clip Spring	4299101020	-	\$15.00	-	-	-	-	-	-	-
9547/48/75 Pushpad	971763	.[Finish]	-	-	\$347.00	\$391.00	\$373.00	\$430.00	\$412.00	-
9447/48/75 Pushpad	971764	.[Finish]	-	-	\$347.00	\$391.00	\$373.00	\$430.00	\$412.00	-
9547/48-F/75-F Pushpad	971765	.[Finish]	-	-	\$347.00	\$391.00	\$373.00	\$430.00	\$412.00	-
9447/48-F/75-F Pushpad	971766	.[Finish]	-	-	\$347.00	\$391.00	\$373.00	\$430.00	\$412.00	-
Baseplate Link Pin	971706	-	\$24.00	-	-	-	-	-	-	-
9547/48/75 Pushpad	971709	.[Finish]	-	-	-	-	-	-	-	\$461.00
9447/48/75 Pushpad	971710	.[Finish]	-	-	-	-	-	-	-	\$461.00
94/95 EL Kit Hardware	900626	.[Finish]	\$56.00	-	-	-	-	-	-	-
94/95 Dogging Bracket Assembly	BRKT.131	.[Finish]	\$78.00	-	-	-	-	-	-	-

VERTICAL ROD AND LATCHES

Description	Specify		Non-finished	628	710	612	606
	Part number	Finish					
94/9547/-F Rod Adjustment Kit	KIT.1001	-	\$43.00	-	-	-	-
94/9547/-F Rod Adj. Kit - LBR	KIT.1002	-	\$30.00	-	-	-	-
94/9547/-F Top Rod Kit	RODASY.121	-	\$132.00	-	-	-	-
94/9547/-F Bottom Rod Kit	RODASY.122	-	\$132.00	-	-	-	-
94/9547/-F Extension Rod Kit	051808	-	\$42.00	-	-	-	-
94/9547/-F Top Latch Kit	050492	-	\$405.00	-	-	-	-
94/9547/-F Bottom Latch Kit	050493	-	\$328.00	-	-	-	-
94/9547/-F Ratchet Release Kit	106222	.[Finish]	-	\$196.00	\$196.00	\$196.00	\$196.00
94/9547/-F Latch Mtg. Bracket Kit	109324	-	\$80.00	-	-	-	-

2670 GUARD-X SERIES

605	606	611	612	613	619	622	625	626	626AM	628	629
US3	US4	US9	US10	US10B	US15	US19	US26	US26D	US26DAM	US28	US32
630	630AM	643e	689	691	693	695	706	710	711	721	728
US32D	US32DAM	-	SP28	SP10	SPBLK	SP313	SP4	313	315	US3A	US4A

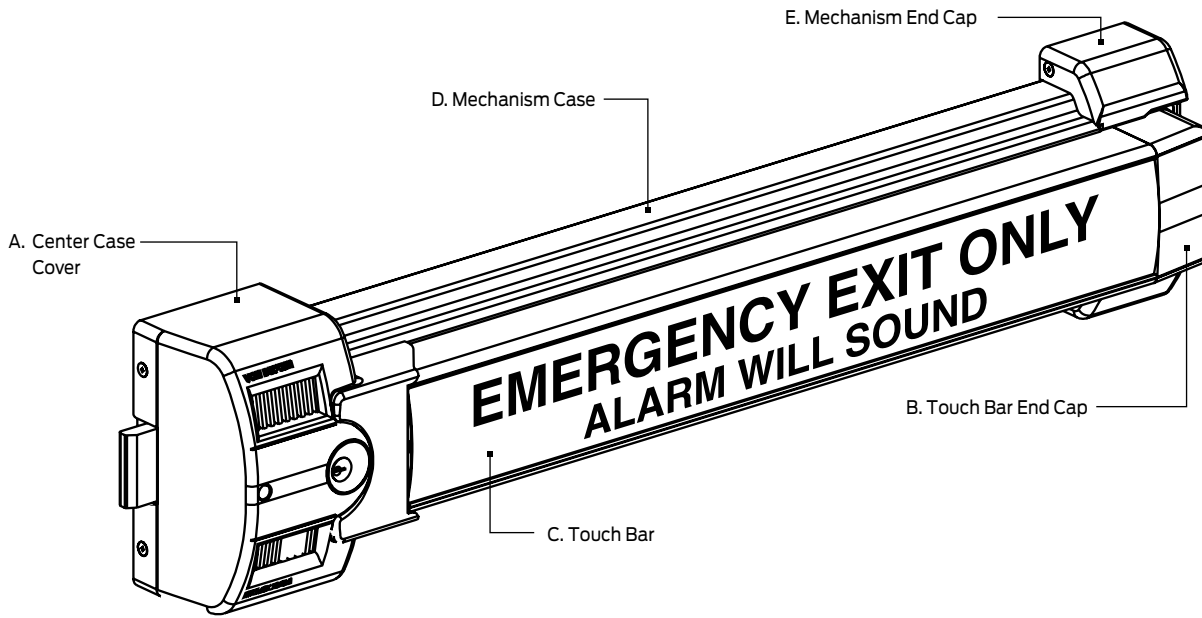

STANDARD FINISHES					
COLOR	US NUMBER	BHMA NUMBER	A, B, E	C -TOUCH BAR FINISHES	D
Anodized Aluminum	US28	628	Plastic - Silver	Satin Stainless Steel US32D, 630	Anodized
Duranodic Dark Bronze	313	710	Plastic - Brown	Duranodic Dark Bronze 313, 710	Powder Coat
Black	315	711	Plastic - Black	Black 315, 711	Powder Coat

2670 SERIES SEX BOLT QUANTITIES	
APPLICATION	SEX BOLT 325 (OPTIONAL)
Aluminum Door	6

2670 GUARD-X SERIES

605	606	611	612	613	619	622	625	626	626AM	628	629
US3	US4	US9	US10	US10B	US15	US19	US26	US26D	US26DAM	US28	US32
630	630AM	643e	689	691	693	695	706	710	711	721	728
US32D	US32DAM	-	SP28	SP10	SPBLK	SP313	SP4	313	315	US3A	US4A

TYPE OF DEVICE

2670
GUARD-X

DEVICE FINISH

628: Anodized Aluminum (US28) 710: Duranodic Dark Bronze (313) 711: Black (315)

DEVICE LENGTH (FEET AND INCHES)

36" to 48" Door Width

DEVICE HANDING

RHR: Right Hand Reverse LHR: Left Hand Reverse

TRIM OPTIONS

LT: Less Trim 210DT: Dummy Pull Trim 230DT: Dummy Pull Trim

TRIM FINISH

689: Painted Aluminum (SP28) 695: Painted Dark Bronze (SP313)

STORM RATING

HH: Wind and Impact - Hurricane Rated HW: Wind Only - Hurricane Rated

STRIKE SERIES

LS: Less Strike 267: Standard 2609: Double Door Strike

STRIKE FINISH

622: Matte Black (US19)

PUSHPAD OPTIONS

ENG: English with Braille Standard FR: French SP: Spanish

MISC DEVICE OPTIONS

SNB: Include # of Sex Bolts CYL: 3216 Rim Cylinder

DOOR THICKNESS

DT1-3/4: 1-3/4" Standard

2670 GUARD-X SERIES

605	606	611	612	613	619	622	625	626	626AM	628	629
US3	US4	US9	US10	US10B	US15	US19	US26	US26D	US26DAM	US28	US32
630	630AM	643e	689	691	693	695	706	710	711	721	728
US32D	US32DAM	-	SP28	SP10	SPBLK	SP313	SP4	313	315	US3A	US4A

DEVICE					
Description	Specify		628	710	711
	Model number	Finish			
36" to 48" Door Width	2670	.[Finish]	\$923	\$923	\$923

Note: Pushpad Sign furnished in English with Braille standard. French and Spanish language available at no additional charge.

DEFAULT ATTRIBUTES

Pricing includes default options shown below. Additional options and configurations available.

Cylinders:	Sex bolts	Battery	Screw pack
Not included	Not included	Included	Included

Strike(s): Exit hardware:
 ▪ Includes 267 strike

OPTIONS

STORM RATING

HURRICANE DEVICE - USE WITH APPROVED ALLEGION DOOR APPLICATIONS

Specify HH (Wind and Impact) or HW (Wind-Only) prefix when ordering devices or mullions for hurricane applications. If application is unknown, specify HH which will satisfy the requirements for both applications. HH option only available for select series and models. HH/HW devices will be furnished with strikes shown in charts (and with through bolts if HH product) and are price-adjusted as indicated. Mullions priced separately.

HH (WIND AND IMPACT)					
Model	Door mode	Mullion	Standard strike	Specify (Prefix)	Price adjustment
2670	SGL	-	267	HH	\$114.00

HW (WIND ONLY)					
Model	Door mode	Mullion	Standard strike	Specify (Prefix)	Price adjustment
2670	SGL	-	267	HW	\$0.00

PARTS AND ACCESSORIES

605	606	611	612	613	619	622	625	626	626AM	628	629
US3	US4	US9	US10	US10B	US15	US19	US26	US26D	US26DAM	US28	US32
630	630AM	643e	689	691	693	695	706	710	711	721	728
US32D	US32DAM	-	SP28	SP10	SPBLK	SP313	SP4	313	315	US3A	US4A

GUARD-X 26 SERIES

Description	Specify		Non-finished	622 711	689 695
	Part number	Finish			
2670 Lockside Cover Kit SP28	COVER.109	.[Finish]	-	-	\$276.00
2670 Lockside Cover Kit US19	COVER.122	.[Finish]	-	\$271.00	-
2670 Lockside Cover Kit SP313	COVER.121	.[Finish]	-	-	\$271.00
2670 Hingside Cover Kit - Silver	COVER.114	.[Finish]	-	-	\$70.00
2670 Hingside Cover Kit - Black	COVER.115	.[Finish]	-	\$70.00	-
2670 Hingside Cover Kit - Brown	COVER.116	.[Finish]	-	-	\$70.00
2670 End cap Kit	ECAP.105	.[Finish]	-	\$41.00	-
2670 PCB Kit Field - English	PCB.10018	-	\$366.00	-	-
2670 PCB Kit Field - Spanish	PCB.10019	-	\$366.00	-	-
2670 PCB Kit Field - French	PCB.10020	-	\$366.00	-	-
Alarm Sign - French	SIGN.1001	-	\$95.00	-	-
Alarm Sign - Spanish	SIGN.1002	-	\$95.00	-	-
Alarm Sign - English	SIGN.1003	-	\$95.00	-	-
Cylinder Retaining Bracket Kit	BRKT.121	-	\$55.00	-	-
Lightpipe Kit	PIPE.101	-	\$42.00	-	-
2670 Cylinder Tailpiece Extension	050379	-	\$17.00	-	-
2670 Device Mounting Package US28	PKGMTG.1002	.[Finish]	-	-	\$45.00
2670 Device Mounting Package Black	PKGMTG.1003	.[Finish]	-	\$45.00	-
2670 Cover Screw Kit SP28	PKGSCR.1001	-	\$18.00	-	-

ACCESSORIES

Description	Specify		622	689	695	626	613
	Model number	Finish					
9-Volt External Power Supply	PT790	-	\$267.00	-	-	-	-
Dummy Pull Trim and Screw Pack	210DT x 050140	.[Finish]	-	\$98.00	\$98.00	-	-
Dummy Pull Trim and Screw Pack	230DT x 050140	.[Finish]	-	\$174.00	\$174.00	-	-
Rim Cylinder	3216	.[Finish]	-	-	-	\$128.00	\$128.00
Double Door Strike	2609	-	\$160.00	-	-	-	-
267 Strike Pkg	267	-	\$54.00	-	-	-	-

ACCESSORIES AND PARTS

III
22 SERIES
33A/35A SERIES
55 SERIES
88 SERIES
98/99 SERIES
XP98/XP99 SERIES
94/95 SERIES
GUARD-X SERIES
ACCESSORIES / PARTS
ELECTRICAL / PARTS

DUMMY CROSS/TOUCH BARS

605	606	611	612	613	619	622	625	626	626AM	628	629
US3	US4	US9	US10	US10B	US15	US19	US26	US26D	US26DAM	US28	US32
630	630AM	643e	689	691	693	695	706	710	711	721	728
US32D	US32DAM	-	SP28	SP10	SPBLK	SP313	SP4	313	315	US3A	US4A

DUMMY CROSS BARS - 3' DUMMY CROSS BAR PRICED COMPLETE WITH SEX BOLTS.

Description	Specify		626	613	612	606	605, 625, 643e, 693
	Model number	Finish					
55 Series device dummy crossbar, 3'	55DU	.[Finish]	\$2,648.00	\$2,648.00	\$3,076.00	\$2,498.00	\$3,273.00
88 Series device dummy crossbar, 3'	88DU	.[Finish]	\$1,335.00	\$1,335.00	\$1,391.00	\$1,125.00	\$1,557.00

DUMMY TOUCH BARS - 3' DUMMY TOUCH BAR PRICED COMPLETE WITH SEX BOLTS. 4' ADD \$26.00LIST

Description	Specify		626	628	630 ¹	710	606 612	605 625 643e	711	619
	Model number	Finish								
33A/99 Series device dummy touch bar	330	.[Finish]	\$1,133.00	\$945.00	N/A	\$975.00	\$1,019.00	\$1,133.00	\$2,035.00	N/A
35A/98 Series device dummy touch bar	350	.[Finish]	\$1,133.00	\$945.00	\$1,201.00	\$975.00	\$1,019.00	\$1,133.00	\$2,035.00	\$1,133.00

¹ 630 finish available with 350 model only.

Notes: Back-to-back mounting - available on 330, 350 when used with outside trim. Finished fasteners supplied at \$24.00 list add.

Antimicrobial coating - available in 626AM and 630AM (350 Series only) finishes, \$97.00 list add.

OPTIONS

SWITCH OPTIONS	Specify (Prefix)	Price adjustment
Request to Exit Switch. Available for 330, 350, 55DU, 88DU.	RX	\$365.00
Double RX - Request to Exit Switch. Available for 330, 350.	RX-2	\$455.00
Waterproof Request to Exit - Available for 330, 350.	WP-RX	\$529.00
Convert existing RX switch to RX-2 switch. Order part number 050271-00. Available for 330, 350	RX-AUX	\$380.00
Signal Switch. Available for 330/350. Specify handing RHR or LHR.	SS	\$749.00

PARTS AND ACCESSORIES

PUSH BAR

Push Bar Assemblies are for the SS & RX 330/350 only. Push bars can not be replaced on the standard 330/350 Dummy Push Bar.

Description	Specify				Non-finished	628	626	710	612	606	605, 619 ¹ , 625, 711
	Part number	Device type	Size	Finish							
33A/35A Push Bar Retrofit Kit - 3' Dr	PBKIT	[.]	. []	.[Finish]	-	\$298.00	\$352.00	\$322.00	\$482.00	\$465.00	\$550.00
33A/35A Push Bar Retrofit Kit - 4' Dr	PBKIT	[.]	. []	.[Finish]	-	\$320.00	\$388.00	\$347.00	\$502.00	\$482.00	\$571.00
33A/35A Push Bar Guide Pkg/10	090049			-	\$20.00	-	-	-	-	-	-
33A Fire or Less Dogging Cover Plate Kit	050133	[.]	. []	.[Finish]	-	\$62.00	-	\$62.00	\$62.00	\$62.00	\$62.00
35A Fire or Less Dogging Cover Plate Kit	050109	[.]	. []	.[Finish]	-	\$62.00	-	\$62.00	\$62.00	\$62.00	\$62.00
RX/SS 330/350 Spacer Pkg/2	090047	[.]	. []	-	\$40.00	-	-	-	-	-	-
RX/SS 330/350 Baseplate Bearing Strip Pkg/2	090048	[.]	. []	-	\$19.00	-	-	-	-	-	-

END CAP

Description	Specify		Non-finished	628	626	710	612	606	605, 619 ¹ , 625, 711
	Part number	Finish							
330/350 End Cap Kit for Lock Stile	050014	.[Finish]	-	\$115.00	\$128.00	\$115.00	\$142.00	\$130.00	\$130.00
RX330/350 End Cap Mtg Bracket for Lock Stile	050524	-	\$17.00	-	-	-	-	-	-

STRIKES

605	606	611	612	613	619	622	625	626	626AM	628	629
US3	US4	US9	US10	US10B	US15	US19	US26	US26D	US26DAM	US28	US32
630	630AM	643e	689	691	693	695	706	710	711	721	728
US32D	US32DAM	-	SP28	SP10	SPBLK	SP313	SP4	313	315	US3A	US4A

RIM STRIKES											
Application	Specify		Standard		Optional						
	Model number	Finish	Non finished	622	626	630	606, 612, 613	605	625	629	689 695
22/88/98/99, 98/9957 Panic - Optional	264	.[Finish]	-	\$145.00	\$168.00	-	-	-	-	-	-
88 Fire - Standard	268	.[Finish]	-	\$180.00	-	\$210.00	\$239.00	\$253.00	-	\$253.00	-
22/88/98/99, 98/9957 Panic - Standard	299	.[Finish]	-	\$88.00	\$104.00	-	\$104.00	\$136.00	\$136.00	-	-
22/98/99 Fire, 98/9957 Fire - Standard	299F	.[Finish]	-	\$109.00	-	\$146.00	\$171.00	\$197.00	-	\$197.00	-
HH88-F x HH9954 Mullion	468	.[Finish]	-	\$150.00	-	-	-	-	-	-	-
22/98/99 Fire w/9954 Mullion - Standard	499F	.[Finish]	-	\$259.00	-	\$272.00	-	-	-	-	-
Panic w/5754 Mullion - Standard	1408	-	\$392.00	-	-	-	-	-	-	-	-
55 Panic - Standard/22 - Optional	1409	-	\$210.00	-	-	-	-	-	-	-	-
Panic, Integral Stop - Optional	1410	-	\$210.00	-	-	-	-	-	-	-	-
33A/35A Panic - Standard/22 - Optional	1439	.[Finish]	-	\$210.00	-	-	-	-	-	-	-
33A/35A-F - Optional	1439F	.[Finish]	-	\$219.00	-	-	-	-	-	-	-
Panic, Sgl or Pr w/1654 Mullion - Optional	1606	-	\$104.00	-	-	-	-	-	-	-	-
Panic - Optional ¹	1609	.[Finish]	-	\$145.00	\$163.00	-	\$163.00	\$175.00	\$175.00	-	-
88 Panic, Stock HM Doors - Optional ¹	1610	.[Finish]	-	\$145.00	\$163.00	-	\$163.00	\$175.00	\$175.00	-	-
98/9952 Roller Strike	699	.[Finish]	-	\$165.00	-	-	-	-	-	-	\$165.00
2670 GUARD-X - Standard	267	.[Finish]	-	\$54.00	-	-	-	-	-	-	-
2670 GUARD-X, Pairs - Optional	2609	.[Finish]	-	\$160.00	-	-	-	-	-	-	-
XP98/99 - Standard	909	.[Finish]	-	\$109.00	-	-	-	-	-	-	-
XP98/99 Mullion - Optional	954	.[Finish]	-	\$259.00	-	-	-	-	-	-	-
299F Strike Adapter	050996-622	.[Finish]	-	\$233.00	-	-	-	-	-	-	-

¹ 1609 and 1610 must be used with coordinator. Not a UL Fire Exit Hardware listed application.

VERTICAL ROD TOP STRIKES											
Application	Specify		Standard		Optional						
	Model number	Finish	Non finished	622	626	630	606, 612, 613	605	625	691	689 695
33/3550AWDC/98/9950WDC includes shims and fasteners	150	-	\$60.00	-	-	-	-	-	-	-	-
33/3549A/98/9949 includes shims and fasteners	249	-	\$61.00	-	-	-	-	-	-	-	-
22/33A/35A/88/98/9927/57 Panic, Flush Transom	260U	.[Finish]	-	\$145.00	\$163.00	-	\$163.00	\$197.00	\$197.00	\$163.00	-
22/33A/88/98/9927/57 Fire Flush Transom	260U-F	.[Finish]	-	-	-	\$404.00	-	-	-	-	-
22/33A/35A/88/98/9927/57 Panic - Optional	264	.[Finish]	-	\$145.00	\$168.00	-	-	-	-	-	-
33/3527A Panic - Standard	266	.[Finish]	-	\$163.00	-	\$180.00	\$203.00	\$229.00	-	\$229.00	-

STRIKES

605	606	611	612	613	619	622	625	626	626AM	628	629
US3	US4	US9	US10	US10B	US15	US19	US26	US26D	US26DAM	US28	US32
630	630AM	643e	689	691	693	695	706	710	711	721	728
US32D	US32DAM	-	SP28	SP10	SPBLK	SP313	SP4	313	315	US3A	US4A

VERTICAL ROD TOP STRIKES

Application	Specify		Standard		Optional						
	Model number	Finish	Non finished	622	626	630	606, 612, 613	605	625	691	689 695
33A/35A/98/9947WDC, Wood Frames - specify door thickness	283	-	\$93.00	-	-	-	-	-	-	-	-
22/88/98/9927/57 Panic - Standard	299	.[Finish]	-	\$88.00	\$104.00	-	\$104.00	\$136.00	\$136.00	-	-
22/98/9927 Fire - Standard	299F	.[Finish]	-	\$109.00	-	\$146.00	\$171.00	\$197.00	-	\$197.00	-
33A/35A/98/9947 and WDC - Standard	338	-	\$93.00	-	-	-	-	-	-	-	-
33/3527A/98/9927 LBR Fire, Pairs - Standard	499F	.[Finish]	-	\$259.00	-	\$272.00	-	-	-	-	-
5547 Panic, HM Frame - Standard	471U	-	\$88.00	-	-	-	-	-	-	-	-
5547WDC, 1-3/4" Dr, WD Frame - Standard	472U	.[Finish]	-	\$88.00	\$90.00	-	\$94.00	\$122.00	\$122.00	-	-
5547WDC, 2-1/4" Dr, WD Frame - Standard	473U	.[Finish]	-	\$88.00	\$90.00	-	\$94.00	\$122.00	\$122.00	-	-

VERTICAL ROD BOTTOM STRIKES

Application	Specify		Standard		Optional						
	Model number	Finish	Non finished	622	626	630	606 612	605	625	629	689 695
22/33A/35A/98/9927, 98/9957 Panic - Standard	248L-4	-	\$82.00	-	-	-	-	-	-	-	-
55/8847 Fire - Standard	301L	-	\$188.00	-	-	-	-	-	-	-	-
22/33A/35A/98/9927, 98/9957 - Standard	304L	-	\$82.00	-	-	-	-	-	-	-	-
33/3594A/98/9949 includes anchors and fasteners	349	-	\$36.00	-	-	-	-	-	-	-	-
33A/35A/98/9947/48 and WDC - Standard ¹	385A	-	\$179.00	-	-	-	-	-	-	-	-
33/3550AWDC/98/9950WDC includes anchor and fasteners	450	-	\$34.00	-	-	-	-	-	-	-	-

¹ The 385A is recommended over the 304L for wood door applications based on its adjustability.

MORTISE LOCK STRIKES

Application	Specify		Standard		Optional						
	Model number	Finish	Non finished	622	626	630	606, 612, 613	605	625	629	689 695
55/88/98/9975 - Standard	575	-	\$66.00	-	-	\$93.00	\$175.00	\$199.00	-	\$199.00	-
55/88/99/9875, Pairs 1-3/4" Dr - Optional	575-2	-	\$66.00	-	-	\$93.00	\$175.00	\$199.00	-	\$199.00	-
55/88/98/9975, Pairs 1-3/4" Dr - Optional	576A	-	\$180.00	-	-	\$188.00	\$215.00	\$238.00	-	\$238.00	-
55/88/99/9875, Pairs 2-1/4" Dr - Optional	576B	-	\$180.00	-	-	\$188.00	\$215.00	\$238.00	-	\$238.00	-

TRIMS

605	606	611	612	613	619	622	625	626	626AM	628	629
US3	US4	US9	US10	US10B	US15	US19	US26	US26D	US26DAM	US28	US32
630	630AM	643e	689	691	693	695	706	710	711	721	728
US32D	US32DAM	-	SP28	SP10	SPBLK	SP313	SP4	313	315	US3A	US4A

22 SERIES

22 SERIES TRIM							
Description	Specify		689 695	613 626	526	622	
	Model number	Finish					
STANDARD:							
Dummy Trim	210DT	.[Finish]	\$74.00	-	\$96.00	\$80.00	
Night Latch	210NL	.[Finish]	\$85.00	-	\$111.00	\$94.00	
Knob	210K	.[Finish]	\$333.00	-	\$434.00	\$367.00	
Lever	230L	.[Finish]	\$327.00	-	\$427.00	\$360.00	
Thumbpiece	230TP	.[Finish]	\$324.00	-	\$422.00	\$357.00	
OPTIONAL:							
Knob, Blank Escutcheon	210K-BE	.[Finish]	\$333.00	-	\$434.00	\$367.00	
Exit Only Trim Plate	230EO	.[Finish]	\$136.00	-	\$178.00	\$151.00	
Dummy Trim	230DT	.[Finish]	\$150.00	-	\$172.00	\$156.00	
Night Latch	230NL	.[Finish]	\$166.00	-	\$217.00	\$183.00	
Lever, Blank Escutcheon	230L-BE	.[Finish]	\$327.00	-	\$427.00	\$360.00	
Thumbpiece, Blank Escutcheon	230TP-BE	.[Finish]	\$324.00	-	\$422.00	\$357.00	
Night Latch Cylinder Assembly - HM Door	110MD-NL	.[Finish]	-	\$188.00	\$188.00	\$188.00	
Night Latch Cylinder Assembly - WD Door	110WD-NL	.[Finish]	-	\$188.00	\$188.00	\$188.00	

33A/35A SERIES

33A/35A SERIES TRIM - STANDARD									
Description	Specify		626	613, 693, 695	612	606	605, 619, 625, 643e	622	
	Model number	Finish							
Dummy Trim	386DT	.[Finish]	\$494.00	\$494.00	\$692.00	\$494.00	\$617.00	\$494.00	
Night Latch - Specify handing	386NL	.[Finish]	\$877.00	\$877.00	\$1,075.00	\$877.00	\$1,000.00	\$877.00	
Night Latch Cylinder Trim	388	.[Finish]	\$434.00	\$434.00	\$623.00	\$405.00	\$434.00	\$405.00	

33A/35A SERIES TRIM - OPTIONAL									
Description	Specify		626	613, 695	612	606	605, 693, 625, 643e	619	
	Model number	Finish							
Dummy Trim - only available with 388 cyl. trim (Rim only)	550DT	.[Finish]	\$792.00	\$792.00	\$801.00	\$626.00	\$814.00	\$763.00	
Dummy Offset Pull	392-6	.[Finish]	\$305.00	-	-	-	-	-	

Note: Antimicrobial coating - available in 626AM finish, \$45.00 list add.

For other possible trim applications not shown, consult Von Duprin.

TRIMS

605	606	611	612	613	619	622	625	626	626AM	628	629
US3	US4	US9	US10	US10B	US15	US19	US26	US26D	US26DAM	US28	US32
630	630AM	643e	689	691	693	695	706	710	711	721	728
US32D	US32DAM	-	SP28	SP10	SPBLK	SP313	SP4	313	315	US3A	US4A

55 SERIES

55 SERIES TRIM								
Description	Specify		626	613	612	606	605, 625, 643e	622, 693
	Model number	Finish						
STANDARD:								
Dummy Trim	550DT	.[Finish]	\$792.00	\$792.00	\$801.00	\$626.00	\$814.00	\$814.00
Night Latch Trim - HM Door	555NL	.[Finish]	\$1,042.00	\$1,042.00	\$1,051.00	\$876.00	\$1,064.00	\$1,064.00
Night Latch Trim - WD Door	556NL	.[Finish]	\$1,042.00	\$1,042.00	\$1,051.00	\$876.00	\$1,064.00	\$1,064.00
Dummy Trim	609DT	.[Finish]	\$539.00	\$539.00	\$539.00	\$415.00	\$596.00	\$539.00
Night Latch Cylinder Assembly - HM Door	110MD-NL	.[Finish]	\$188.00	\$188.00	\$188.00	\$173.00	\$188.00	\$188.00
Night Latch Cylinder Assembly - WD Door	110WD-NL	.[Finish]	\$188.00	\$188.00	\$188.00	\$173.00	\$188.00	\$188.00
Night Latch Cylinder Assembly - HM Door	555NL-CA	.[Finish]	\$515.00	\$515.00	\$515.00	\$434.00	\$515.00	\$515.00
Night Latch Cylinder Assembly - WD Door	556NL-CA	.[Finish]	\$515.00	\$515.00	\$515.00	\$434.00	\$515.00	\$515.00

88 SERIES

88 SERIES TRIM - SPECIFY DEVICE TYPE WHEN ORDERING (EXAMPLE: 880TP-V)								
Description	Specify			626	613	612	606	605, 619, 622, 625, 629, 693, 643e
	Model number	Device type	Finish					
STANDARD:								
Exit Only Trim Plate	880EO ¹	.[R or V&M]	.[Finish]	\$289.00	\$305.00	\$349.00	\$208.00	\$357.00
Dummy Trim	880DT	.[R, V&M or V-SA]	.[Finish]	\$372.00	\$398.00	\$483.00	\$286.00	\$483.00
Night Latch	880NL	.[R or M]	.[Finish]	\$398.00	\$424.00	\$509.00	\$312.00	\$509.00
Thumbpiece	880TP	.[R, V, or M]	.[Finish]	\$414.00	\$442.00	\$579.00	\$395.00	\$579.00
Thumbpiece, Blank Escutcheon	880TP-BE	.[R, V, or M]	.[Finish]	\$414.00	\$442.00	\$579.00	\$395.00	\$579.00
Knob	880K	.[R, V, or M]	.[Finish]	\$484.00	\$520.00	\$617.00	\$395.00	\$617.00
Knob, Blank Escutcheon	880K-BE	.[R, V, or M]	.[Finish]	\$484.00	\$520.00	\$617.00	\$395.00	\$617.00
Knob, Dummy	880K-DT	.[R, V, or M]	.[Finish]	\$484.00	\$520.00	\$617.00	\$395.00	\$617.00
Knob, Night Latch	880K-NL	.[R only]	.[Finish]	\$484.00	\$520.00	\$617.00	\$395.00	\$617.00
OPTIONAL:								
Dummy Trim	608DT	-	.[Finish]	\$539.00	\$539.00	\$539.00	\$415.00	\$596.00
Night Latch	608NL	.[R or M]	.[Finish]	\$546.00	\$546.00	\$546.00	\$416.00	\$597.00
Thumbpiece	608TP	.[R, V or M]	.[Finish]	\$588.00	\$551.00	\$588.00	\$448.00	\$682.00
Thumbpiece, Blank Escutcheon	608TP-BE	.[R or M&V]	.[Finish]	\$588.00	\$551.00	\$588.00	\$448.00	\$682.00
Knob	606K	-	.[Finish]	\$588.00	\$588.00	\$630.00	\$490.00	\$630.00
Knob, Blank Escutcheon	606K-BE	-	.[Finish]	\$588.00	\$588.00	\$630.00	\$490.00	\$630.00
Knob, Dummy	606K-DT	-	.[Finish]	\$588.00	\$588.00	\$630.00	\$490.00	\$630.00

¹ 880 Trim - when used with 88-F Rim devices on wood or composite doors use trim suffix "WDF" (no additional charge) ex. 880WDF-EO

For other possible trim applications not shown, consult Von Duprin.

TRIMS

605	606	611	612	613	619	622	625	626	626AM	628	629
US3	US4	US9	US10	US10B	US15	US19	US26	US26D	US26DAM	US28	US32
630	630AM	643e	689	691	693	695	706	710	711	721	728
US32D	US32DAM	-	SP28	SP10	SPBLK	SP313	SP4	313	315	US3A	US4A

98/99 SERIES

98/99 SERIES TRIM - SPECIFY DEVICE TYPE WHEN ORDERING (EXAMPLE: 990TP-R)									
Description	Specify			626	695 613	622 ¹ 693	612	606	605, 619, 625, 643e
	Model number	Device type	Finish						
STANDARD:									
Exit Only Trim Plate	990EO	-	.[Finish]	\$240.00	\$240.00	\$240.00	\$300.00	\$197.00	\$271.00
Exit Only with Cylinder Hole	990EO-w/CH	-	.[Finish]	\$271.00	\$271.00	\$271.00	\$331.00	\$228.00	\$302.00
Dummy Trim	990DT	-	.[Finish]	\$362.00	\$378.00	\$378.00	\$378.00	\$291.00	\$394.00
Night Latch	990NL	.[R/V or M]	.[Finish]	\$383.00	\$399.00	\$399.00	\$399.00	\$312.00	\$415.00
Thumbpiece	990TP	.[R/V or M]	.[Finish]	\$518.00	\$532.00	\$532.00	\$518.00	\$431.00	\$557.00
Thumbpiece, Blank Escutcheon	990TP-BE	.[R/V or M]	.[Finish]	\$518.00	\$532.00	\$532.00	\$518.00	\$431.00	\$557.00
Knob	996K	.[R/V or M]	.[Finish]	\$636.00	\$636.00	\$636.00	\$721.00	\$535.00	\$769.00
Knob, Blank Escutcheon	996K-BE	.[R/V or M]	.[Finish]	\$636.00	\$636.00	\$636.00	\$721.00	\$535.00	\$769.00
Knob, Dummy	996K-DT	-	.[Finish]	\$622.00	\$622.00	\$622.00	\$707.00	\$521.00	\$755.00
Knob, Night Latch	996K-NL	.[R/V or M]	.[Finish]	\$622.00	\$622.00	\$622.00	\$707.00	\$521.00	\$755.00
Night Latch Cyl. Assy, MD Dr	110MD-NL	-	.[Finish]	\$188.00	\$188.00	\$188.00	\$188.00	\$173.00	\$188.00
Night Latch Cyl. Assy, WD Dr	110WD-NL	-	.[Finish]	\$188.00	\$188.00	\$188.00	\$188.00	\$173.00	\$188.00
OPTIONAL:									
Dummy Trim	696DT ²	-	.[Finish]	\$549.00	\$549.00	\$549.00	\$549.00	\$425.00	\$606.00
Night Latch	696NL ²	.[R/V or M]	.[Finish]	\$608.00	\$608.00	\$608.00	\$608.00	\$478.00	\$659.00
Thumbpiece	696TP ²	.[R/V or M]	.[Finish]	\$679.00	\$642.00	\$679.00	\$679.00	\$539.00	\$773.00
Thumbpiece, Blank Escutcheon	696TP-BE ²	.[R/V or M]	.[Finish]	\$679.00	\$642.00	\$679.00	\$679.00	\$539.00	\$773.00
Dummy Trim	697DT ²	-	.[Finish]	\$549.00	\$549.00	\$549.00	\$549.00	\$425.00	\$606.00
Night Latch	697NL ²	.[R/V or M]	.[Finish]	\$608.00	\$608.00	\$608.00	\$608.00	\$478.00	\$659.00
Thumbpiece	697TP ²	.[R/V or M]	.[Finish]	\$679.00	\$642.00	\$679.00	\$679.00	\$539.00	\$773.00
Thumbpiece, Blank Escutcheon	697TP-BE ²	.[R/V or M]	.[Finish]	\$679.00	\$642.00	\$679.00	\$679.00	\$539.00	\$773.00
Exit Only Trim Plate	996EO ²	.[R/V or M]	.[Finish]	\$477.00	\$477.00	\$477.00	\$566.00	\$458.00	\$566.00
Dummy Wire Pull	392-7 ²	-	.[Finish]	\$333.00	-	-	-	-	-

¹ 622 available on 996, 696 and 697 trims.

² Wood or Composite Fire Labeled Doors - when using 696/697 trims with 98/99-F Rim Fire devices use trim suffix "WDF", ex. 696WDF. No additional charge.

OPTIONS

ANTIMICROBIAL FINISH	Specify (Prefix)	Price adjustment
Antimicrobial Coating available in 626, use suffix-AM when ordering. Example 626AM	AM	\$45.00

DOOR THICKNESS >2-1/4" - 4-1/4"	Specify (Prefix)	Price adjustment
110NL-MD or 110NL-WD	Door Thickness > 2-1/4" - <= 4-1/4"	\$128.00
990EO, DT or NL	Door Thickness > 2-1/4" - <= 4-1/4"	\$128.00
996L/L-BE	Door Thickness > 2-1/4" - <= 4"	\$746.00
996L-NL	Door Thickness > 2-1/4" - <= 4"	\$150.00
996L-DT	Door Thickness > 2-1/4" - <= 4"	\$150.00

For other possible trim applications not shown, consult Von Duprin.

TRIMS

605	606	611	612	613	619	622	625	626	626AM	628	629
US3	US4	US9	US10	US10B	US15	US19	US26	US26D	US26DAM	US28	US32
630	630AM	643e	689	691	693	695	706	710	711	721	728
US32D	US32DAM	-	SP28	SP10	SPBLK	SP313	SP4	313	315	US3A	US4A

98/99 SERIES

98/99 SERIES TRIM - SPECIFY DEVICE TYPE WHEN ORDERING (EXAMPLE: 996L-R)

Description	Specify			622, 626, 695	629 ¹ 630 ¹	613	693	612	606	605, 619, 625, 643e
	Model number	Device type	Finish							
LEVER TRIM WITH STANDARD LEVER DESIGNS										
Lever	996L	.[R/V or M]	.[Finish]	\$828.00	\$969.00	\$858.00	\$858.00	\$901.00	\$786.00	\$937.00
Lever, Blank Escutcheon	996L-BE	.[R/V or M]	.[Finish]	\$828.00	\$969.00	\$858.00	\$858.00	\$901.00	\$786.00	\$937.00
Lever, Dummy	996L-DT	-	.[Finish]	\$660.00	\$801.00	\$690.00	\$690.00	\$733.00	\$618.00	\$769.00
Lever, Night Latch	996L-NL	.[R/V or M]	.[Finish]	\$660.00	\$801.00	\$690.00	\$690.00	\$733.00	\$618.00	\$769.00
Lever, Key Capture	996L-KC	.[R/V]	.[Finish]	\$828.00	\$969.00	\$858.00	\$858.00	\$901.00	\$786.00	\$937.00
LEVER TRIM WITH M COLLECTION LEVER DESIGNS²										
Lever	996L	.[R/V or M]	.[Finish]	\$969.00	\$969.00	\$969.00	\$969.00	\$969.00	\$969.00	\$969.00
Lever, Blank Escutcheon	996L-BE	.[R/V or M]	.[Finish]	\$969.00	\$969.00	\$969.00	\$969.00	\$969.00	\$969.00	\$969.00
Lever, Dummy	996L-DT	-	.[Finish]	\$801.00	\$801.00	\$801.00	\$801.00	\$801.00	\$801.00	\$801.00
Lever, Night Latch	996L-NL	.[R/V or M]	.[Finish]	\$801.00	\$801.00	\$801.00	\$801.00	\$801.00	\$801.00	\$801.00
Lever, Key Capture	996L-KC	.[R/V]	.[Finish]	\$969.00	\$969.00	\$969.00	\$969.00	\$969.00	\$969.00	\$969.00

¹ 630 lever furnished with 619 trim plate. 629 lever furnished with 625 trim plate. Please see stainless steel lever designs below.

² (For Canada only) To order 996 trim in M collection, deduct the standard trim price, and add the M collection upcharge.

OPTIONS

LEVER DESIGNS

Standard	<ul style="list-style-type: none"> 06 Lever Design - furnished standard Optional Lever Designs - 01, 02, 03, 05, 07, 12, 16, 17, 18, Accent (ACC), Asti (AST), Merano (MER), Latitude (LAT), Longitude (LON) Stainless Steel Levers - 03-SS, 06-SS, 17-SS, Latitude-SS (LAT-SS), Longitude-SS (LON-SS) are available in 629 or 630
M Collection	<ul style="list-style-type: none"> M51, M52, M53, M54, M55, M56, M57, M61, M62, M63, M81, M82, M83, M84, M85, ME1, ME2, ME3 Stainless Steel Levers - M57 and M62 lever designs available in stainless steel only
Handing	<ul style="list-style-type: none"> Field reversible and furnished RHR if not specified on all lever designs except 12, AST, MER, ACC, M61, M62, M63, M85 Specify handing RHR or LHR for lever designs 12, AST, MER, ACC, M61, M62, M63, M85, ME1, ME2

KNURLED LEVER	Specify (Suffix)	Price adjustment
Available standard on 02, 03, 06, 07, 17, ME1, ME2, and ME3 lever designs. Specify suffix KN (06-KN)	KN	\$150.00
Available for special order on M51, M52, and M81 lever designs. Specify suffix KN (M51-KN)		\$228.00

ANTIMICROBIAL FINISH	Specify (Suffix)	Price adjustment
Antimicrobial Coating available in 626, use suffix-AM when ordering. Example 626AM	AM	\$45.00

QUIET MECHANICAL	Specify (Prefix)	Price adjustment
Controls motion to reduce operational noise. The QM trim option provides damper-controlled lever return. Available on 996L/LBE - R/V/M. Not available with M996 and RX996.	QM	\$266.00

DOUBLE CYLINDER	Specify (Suffix)	Price adjustment
996L/LBE -2 for use with -2 and 2SI devices	-2	\$17.00

ELECTRIC UNLOCKING	Specify (Prefix)	Price adjustment
Motor Driven Electric Unlocking of outside M996 Trim - for 98/99 rim, mortise, surface vertical and concealed vertical devices. Available with L or LBE functions only. Specify handing. Dual voltage - works with either 12 or 24 VDC power supplies, furnished Fail Safe (FS) but can be converted in the field with dip switch without mechanical conversion. See page 146 for pricing and optional lever designs.	M996	\$916.00

For other possible trim applications not shown, consult Von Duprin.

TRIMS

605	606	611	612	613	619	622	625	626	626AM	628	629
US3	US4	US9	US10	US10B	US15	US19	US26	US26D	US26DAM	US28	US32
630	630AM	643e	689	691	693	695	706	710	711	721	728
US32D	US32DAM	-	SP28	SP10	SPBLK	SP313	SP4	313	315	US3A	US4A

SWITCH	Specify (Prefix)	Price adjustment
Request to exit 996L option available for use with 98/99 rim, mortise, surface and concealed devices. Specify trim "RX996"	RX	\$365.00

CONNECTORS	Specify (Suffix)	Price adjustment
Cross-category solution using common interconnect components for electrified options. Available with M996 trim.	CON	\$0.00

KITS

ELECTRICAL UNLOCKING RETROFIT KITS	Specify	Price each
996 R/V/C Conversion to M996 Motorized Kit	47273111	\$998.00
996 Mort Conversion to M996 Motorized Kit	47273112	\$1,040.00
996L-KC Trim Retrofit Kit	47683326	\$21.00

94/95 SERIES

94/95 SERIES CONTROLS							
Description	Specify		622, 626	613, 695, 693	612	606	605, 625, 643e
	Model number	Finish					
STANDARD LEVER DESIGNS							
Lever	940L ¹	.[Finish]	\$967.00	\$997.00	\$1,040.00	\$925.00	\$1,076.00
Lever, Blank Escutcheon	940L-BE	.[Finish]	\$967.00	\$997.00	\$1,040.00	\$925.00	\$1,076.00
Lever, Dummy	940L-DT	.[Finish]	\$1,078.00	\$1,108.00	\$1,151.00	\$1,036.00	\$1,187.00
M COLLECTION LEVER DESIGNS							
Lever	940L ¹	.[Finish]	\$1,108.00	\$1,108.00	\$1,108.00	\$1,108.00	\$1,108.00
Lever, Blank Escutcheon	940L-BE	.[Finish]	\$1,108.00	\$1,108.00	\$1,108.00	\$1,108.00	\$1,108.00
Lever, Dummy	940L-DT	.[Finish]	\$1,219.00	\$1,219.00	\$1,219.00	\$1,219.00	\$1,219.00

¹ NL spring (600339) included for optional conversion to L-NL function.

OPTIONS

LEVER DESIGNS	
Standard	<ul style="list-style-type: none"> 06 Lever Design - furnished standard Optional Lever Designs - 01, 02, 03, 05, 07,12,16,17,18, Accent (ACC), Asti (AST), Merano (MER), Latitude (LAT), Longitude (LON) Stainless Steel Levers - 03-SS, 06-SS, 17-SS, Latitude-SS (LAT-SS), Longitude-SS (LON-SS) are available in 629 or 630 through special order.
M Collection	<ul style="list-style-type: none"> M51, M52, M53, M54, M55, M56, M57, M61, M62, M63, M81, M82, M83, M84, M85, ME1, ME2, ME3 Stainless Steel Levers - M57 and M62 lever designs available in stainless steel only
Handing	<ul style="list-style-type: none"> Field reversible and furnished RHR if not specified on all lever designs except 12, AST, MER, ACC, M61, M62, M63, M85 Specify handing RHR or LHR for lever designs 12, AST, MER, ACC, M61, M62, M63, M85, ME1, ME2

KNURLED LEVER	Specify (Suffix)	Price adjustment
Available standard on 02, 03, 06, 07, 17, ME1, ME2, and ME3 lever designs. Specify suffix KN (06-KN)	KN	\$150.00
Available for special order on M51, M52, and M81 lever designs. Specify suffix KN (M51-KN)		\$228.00

ANTIMICROBIAL FINISH	Specify (Suffix)	Price adjustment
Antimicrobial Coating available in 626, use suffix-AM when ordering. Example 626AM	AM	\$45.00

For other possible trim applications not shown, consult Von Duprin.

Z2 SERIES
 33A/35A SERIES
 55 SERIES
 88 SERIES
 98/99 SERIES
 XP98/XP99 SERIES
 94/95 SERIES
 GUARD-X SERIES
 ACCESSORIES / PARTS
 ELECTRICAL / PARTS

PARTS AND ACCESSORIES

605	606	611	612	613	619	622	625	626	626AM	628	629
US3	US4	US9	US10	US10B	US15	US19	US26	US26D	US26DAM	US28	US32
630	630AM	643e	689	691	693	695	706	710	711	721	728
US32D	US32DAM	-	SP28	SP10	SPBLK	SP313	SP4	313	315	US3A	US4A

210/230 SERIES TRIMS

Description	Specify		Non-finished	689 695	526	622
	Part number	Finish				
230DT x 330/350 Screw Package 1-3/4" Door	050140	.[Finish]	—	\$24.00	—	\$24.00
230DT x 330/350 Screw Package 2-1/4" Door	050141	.[Finish]	—	\$24.00	—	\$27.00
230L Cylinder Locknut	050526	-	\$20.00	—	—	—
210K Bracket & Booster Assembly	109871	-	\$94.00	—	—	—
210K Spiral Cam Sub-Assembly	109872	-	\$70.00	—	—	—
210K Cylinder Knob Sub-Assembly	109873	.[Finish]	—	\$173.00	—	\$192.00
210K Trim Sub-Assembly	109879	.[Finish]	—	\$178.00	—	\$196.00
210K Rose, Hub and Cap Assy	110343	.[Finish]	—	\$57.00	—	\$62.00
230L Tailpiece Auxiliary	900894	-	\$30.00	—	—	—
210K Wave Spring Washer Pkg/10	090103	-	\$18.00	—	—	—
210/230 Cylinder Retaining Cup	968201	-	\$30.00	—	—	—
210/230 Cylinder Cup & Tailpiece Lead Pkg	900581	-	\$19.00	—	—	—
210/230 Tailpiece Guide Lead Pkg/10	050156	-	\$30.00	—	—	—
210K Knob Spacer	969140	-	\$24.00	—	—	—
210K Knob	969157	.[Finish]	—	\$45.00	—	\$50.00
210K-BE Knob	969352	.[Finish]	—	\$31.00	—	\$34.00
230TP Cam	969903	-	\$19.00	—	—	—
230TP Slider	969904	-	\$19.00	—	—	—
230TP Locking Cam	969906	-	\$19.00	—	—	—
230TP Locking Cam Latch	969908	-	\$30.00	—	—	—
230TP Compression Spring	969909	-	\$19.00	—	—	—
230TP Thumbpiece	969910	.[Finish]	—	\$103.00	\$122.00	\$114.00
210K/L Spindle Shaft	970979	-	\$19.00	—	—	—
230L Stud	971245	-	\$20.00	—	—	—
230L Cylinder Collar	971249	.[Finish]	—	\$36.00	\$43.00	\$41.00
230L Locking Plunger	971497	-	\$19.00	—	—	—
230L Locking Slider	971259	-	\$16.00	—	—	—
230L Lever Cam*	050813	-	\$19.00	—	—	—
230L Shear Pin Kit w/ Retaining Pin*	050611	-	\$19.00	—	—	—

* For 230L trim shipped after 3/3/2014.

386/388 SERIES TRIMS

Description	Specify		Non-finished
	Part number	Finish	
386 Housing Retainer Pkg/2	090104	-	\$18.00
386/388 Cylinder Retainer Pkg	900624	-	\$30.00
386 Mounting Stud Kit	050584	-	\$20.00
386 Mounting Stud Set Screw Pkg/2	090105	-	\$16.00
388 Mounting Stud Pkg/2	090106	-	\$20.00
392-6 Mounting Package	900955	-	\$20.00

PARTS AND ACCESSORIES

605	606	611	612	613	619	622	625	626	626AM	628	629
US3	US4	US9	US10	US10B	US15	US19	US26	US26D	US26DAM	US28	US32
630	630AM	643e	689	691	693	695	706	710	711	721	728
US32D	US32DAM	-	SP28	SP10	SPBLK	SP313	SP4	313	315	US3A	US4A

550/110 SERIES TRIMS

Description	Specify		Non-finished	626	613	612	606	605 625 693
	Part number	Finish						
555/556 Cylinder Disc & Cam Assembly	101212	-	\$270.00	-	-	-	-	-
550/555/556 Pull Bar Assembly	108705	.[Finish]	-	-	\$339.00	\$434.00	\$328.00	\$434.00
550DT Screw Package	900760	.[Finish]	-	\$78.00	\$78.00	\$78.00	\$78.00	\$78.00
555NL Screw Package	900761	-	\$78.00	-	-	-	-	-
556NL Screw Package	900784	.[Finish]	-	\$20.00	\$20.00	\$20.00	\$20.00	\$20.00
556 Rod Member	952820	-	\$180.00	-	-	-	-	-
550/555/556 Special Cylinder Screw - 1-3/4" Door	959055	-	\$19.00	-	-	-	-	-
550/555/556 Special Cylinder Screw - 2-1/4" Door	959056	-	\$19.00	-	-	-	-	-
550/555/556 Hex Stud	959560	-	\$19.00	-	-	-	-	-
555 Cylinder Latch Release RH	959563	-	\$70.00	-	-	-	-	-
555NL-MD Cylinder Spacer Collar - 1-3/4" Door	960003	-	\$42.00	-	-	-	-	-
110NL Cylinder Spacer Collar	960060	-	\$70.00	-	-	-	-	-
555 Cylinder Latch Release LH	960109	-	\$70.00	-	-	-	-	-
110NL-WD Cylinder Spacer Collar	960316	-	\$70.00	-	-	-	-	-
555NL Cylinder Spacer Collar - 2-1/4" Door	960317	-	\$42.00	-	-	-	-	-
556NL Cylinder Spacer Collar - 1-3/4" Door	960676	-	\$42.00	-	-	-	-	-
556NL Cylinder Spacer Collar - 2-1/4" Door	960689	-	\$42.00	-	-	-	-	-
550/555/556 Sex Bolt Extension	960902	-	\$20.00	-	-	-	-	-
110NL Cylinder Assembly Countersink Washer	961180	-	\$20.00	-	-	-	-	-
555NL Cylinder Assembly Cylinder Base	961280	.[Finish]	-	\$80.00	\$79.00	\$79.00	\$73.00	\$79.00
1/8" Short Arm Hex Wrench	050613	-	\$20.00	-	-	-	-	-
556 3/32 Short Hex Key	050614	-	\$19.00	-	-	-	-	-
550/555/556 Socket Set Screw	963581	-	\$19.00	-	-	-	-	-
550/555/556 Pull Base	965310	.[Finish]	-	\$109.00	\$109.00	\$122.00	\$109.00	\$122.00
555/556 Cylinder Pull Base	965312	.[Finish]	-	\$86.00	\$86.00	\$101.00	\$79.00	\$101.00
550/555/556 Cylinder Hole Cover	965317	.[Finish]	-	\$80.00	\$80.00	\$126.00	\$80.00	\$126.00
556NL Cylinder Assembly Cylinder Base	966985	.[Finish]	-	\$180.00	\$180.00	\$208.00	\$180.00	\$208.00
110NL-MD Cylinder Collar	967291	.[Finish]	-	\$76.00	\$76.00	\$86.00	\$76.00	\$86.00
110NL Cylinder Assembly Cylinder Disc	971593	-	\$101.00	-	-	-	-	-

880/606/608 SERIES TRIMS ¹

Description	Specify		Non-finished	626	613	612	606	605 625 693
	Part number	Finish						
216D Cylinder Anchor Plate 880 Trim	032114	-	\$27.00	-	-	-	-	-
606K/880K Orbit Knob Assembly	110544	.[Finish]	-	\$259.00	\$259.00	\$259.00	\$259.00	\$392.00
606K/880K Orbit Knob Assembly (DT)	110547	.[Finish]	-	\$259.00	\$259.00	\$259.00	\$259.00	\$392.00
880 Screw Package 2-1/4" Door	900531	.[Finish]	-	\$31.00	\$43.00	\$31.00	\$31.00	\$31.00
880 Screw Package 1-3/4" Door	900533	.[Finish]	-	\$19.00	\$42.00	\$20.00	\$20.00	\$20.00

¹ For Trims shipped after October 1989. Otherwise, see service replacement page 175.

Z2 SERIES
33A/35A SERIES
55 SERIES
88 SERIES
98/99 SERIES
XP98/XP99 SERIES
94/95 SERIES
GUARD-X SERIES
ACCESSORIES / PARTS
ELECTRICAL / PARTS

PARTS AND ACCESSORIES

605	606	611	612	613	619	622	625	626	626AM	628	629
US3	US4	US9	US10	US10B	US15	US19	US26	US26D	US26DAM	US28	US32
630	630AM	643e	689	691	693	695	706	710	711	721	728
US32D	US32DAM	-	SP28	SP10	SPBLK	SP313	SP4	313	315	US3A	US4A

880/606/608 SERIES TRIMS¹

Description	Specify		Non-finished	626	613	612	606	605 625 693
	Part number	Finish						
880-V Screw Package Trim	900542	-	\$19.00	-	-	-	-	-
880 Screw Package (Bottom Stud)	900771	.[Finish]	-	\$19.00	\$19.00	\$19.00	\$19.00	\$19.00
880DT-V SA Screw Package	900783	.[Finish]	-	\$24.00	\$24.00	\$24.00	\$24.00	\$24.00
606DT/NL/TP Screw Package	900772	.[Finish]	-	\$19.00	\$19.00	\$19.00	\$19.00	\$19.00
606K/606K-DT Screw Package	900782	.[Finish]	-	\$24.00	\$24.00	\$24.00	\$24.00	\$24.00
608 Screw Package	900776	.[Finish]	-	\$20.00	\$20.00	\$20.00	\$20.00	\$20.00
880 Series Hex Stud	956760	-	\$19.00	-	-	-	-	-
880 Pull Grip	972467	.[Finish]	-	-	\$186.00	-	\$153.00	\$249.00
880 Pull Grip	972466	.[Finish]	-	\$186.00	-	-	-	-
880-M/V Thumbpiece	959575	.[Finish]	-	\$98.00	\$98.00	\$90.00	\$90.00	\$138.00
880 Thumbpiece Axle	959603	-	\$19.00	-	-	-	-	-

¹ For Trims shipped after October 1989. Otherwise, see service replacement page 175.

880/606/608 SERIES TRIMS¹

Description	Specify		Non-finished	626 630 ¹	613	612	606	605, 619, ² 625, 629, ¹ 693
	Part number	Finish						
880-M Cylinder Collar	961267	.[Finish]	-	\$62.00	-	\$78.00	\$62.00	\$78.00
880DT-V-SA 12-24 x 1/2" UFPHMS	963011	-	\$18.00	-	-	-	-	-
606K/880K Roll Pin (3-32 x 7/8)	963196	-	\$18.00	-	-	-	-	-
880NL/DT 12-24 x 3/8" UFPHMS	963579	-	\$19.00	-	-	-	-	-
606K/880K 3/8" Lockwasher	963703	-	\$18.00	-	-	-	-	-
606K/880K-DT/K-NL Hex Nut	963704	-	\$18.00	-	-	-	-	-
880-R Cylinder Collar	965226	.[Finish]	-	\$62.00	\$62.00	\$78.00	\$62.00	\$78.00
880 TP Bracket Screw	965237	-	\$18.00	-	-	-	-	-
606/880 DT Spindle Lock	965568	-	\$18.00	-	-	-	-	-
Extended Spindle - 880K	968883	-	\$284.00	-	-	-	-	-
880TP Thumbpiece Bracket	969353	-	\$19.00	-	-	-	-	-
880K Booster Body	970137	-	\$45.00	-	-	-	-	-
880K Booster Torsion Spring	970138	-	\$18.00	-	-	-	-	-
880K Booster Spacer	970139	-	\$18.00	-	-	-	-	-
880K Flange Bearing - 880K	970159	-	\$20.00	-	-	-	-	-
608/880TP-R Thumbpiece	970488	.[Finish]	-	\$98.00	\$98.00	\$138.00	\$90.00	\$138.00

¹ For Trims shipped after October 1989. Otherwise, see service replacement page 175.

² 619 finish available with device series 98 trims.

PARTS AND ACCESSORIES

605	606	611	612	613	619	622	625	626	626AM	628	629
US3	US4	US9	US10	US10B	US15	US19	US26	US26D	US26DAM	US28	US32
630	630AM	643e	689	691	693	695	706	710	711	721	728
US32D	US32DAM	-	SP28	SPI0	SPBLK	SP313	SP4	313	315	US3A	US4A

990/996 SERIES TRIM

Description	Specify		Non-finished	626 630	613	612	606	605, 619, ¹ 625, 629, 693
	Part number	Finish						
#01 Lever - 992 RMV/994/996 L-DT/L-NL	050001	.[Finish]	-	\$308.00	\$308.00	\$347.00	\$308.00	\$420.00
#02 Lever - 992 RMV/994/996 L-DT/L-NL	050002	.[Finish]	-	\$308.00	\$308.00	\$347.00	\$308.00	\$420.00
#03 Lever - 992 RMV/994/996 L-DT/L-NL	050003	.[Finish]	-	\$308.00	\$308.00	\$347.00	\$308.00	\$420.00
#05 Lever - 992 RMV/994/996 L-DT/L-NL	050008	.[Finish]	-	\$308.00	\$308.00	\$347.00	\$308.00	\$420.00
#06 Lever - 992 RMV/994/996 L-DT/L-NL	050006	.[Finish]	-	\$308.00	\$308.00	\$347.00	\$308.00	\$420.00
#07 Lever - 992 RMV/994/996 L-DT/L-NL	050007	.[Finish]	-	\$308.00	\$308.00	\$347.00	\$308.00	\$420.00
#12 Lever - 992 RMV/994/996 L-DT/L-NL (RHR)	050012	.[Finish]	-	\$308.00	\$308.00	\$347.00	\$308.00	\$420.00
#12 Lever - 992 RMV/994/996 L-DT/L-NL (LHR)	050013	.[Finish]	-	\$308.00	\$308.00	\$347.00	\$308.00	\$420.00
#16 Lever - 992 RMV/994/996 L-DT/L-NL	050009	.[Finish]	-	\$308.00	\$308.00	\$347.00	\$308.00	\$420.00
#17 Lever - 992 RMV/994/996 L-DT/L-NL	050017	.[Finish]	-	\$308.00	\$308.00	\$347.00	\$308.00	\$420.00
#18 Lever - 992 RMV/994/996 L-DT/L-NL	050010	.[Finish]	-	\$308.00	\$308.00	\$347.00	\$308.00	\$420.00
#01 Lever - 994/996 RMV L/L-BE	050732	.[Finish]	-	\$308.00	\$308.00	\$347.00	\$308.00	\$420.00
#02 Lever - 994/996 RMV L/L-BE	050733	.[Finish]	-	\$308.00	\$308.00	\$347.00	\$308.00	\$420.00
#03 Lever - 994/996 RMV L/L-BE	050734	.[Finish]	-	\$308.00	\$308.00	\$347.00	\$308.00	\$420.00
#05 Lever - 994/996 RMV L/L-BE	050735	.[Finish]	-	\$308.00	\$308.00	\$347.00	\$308.00	\$420.00
#06 Lever - 994/996 RMV L/L-BE	050736	.[Finish]	-	\$308.00	\$308.00	\$347.00	\$308.00	\$420.00
#07 Lever - 994/996 RMV L/L-BE	050737	.[Finish]	-	\$308.00	\$308.00	\$347.00	\$308.00	\$420.00
#12 Lever - 994/996 RMV L/L-BE RHR	050738	.[Finish]	-	\$308.00	\$308.00	\$347.00	\$308.00	\$420.00
#12 Lever - 994/996 RMV L/L-BE LHR	050739	.[Finish]	-	\$308.00	\$308.00	\$347.00	\$308.00	\$420.00
#16 Lever - 994/996 RMV L/L-BE	050740	.[Finish]	-	\$308.00	\$308.00	\$347.00	\$308.00	\$420.00
#17 Lever - 994/996 RMV L/L-BE	050741	.[Finish]	-	\$308.00	\$308.00	\$347.00	\$308.00	\$420.00
#18 Lever - 994/996 RMV L/L-BE	050742	.[Finish]	-	\$308.00	\$308.00	\$347.00	\$308.00	\$420.00
LON Lever - 996 RMV L/L-BE	051874	.[Finish]	-	\$308.00	\$308.00	\$347.00	\$308.00	\$420.00
LAT Lever - 996 RMV L/L-BE	051872	.[Finish]	-	\$308.00	\$308.00	\$347.00	\$308.00	\$420.00

¹ 619 finish available with device series 98 trims.

990/996 SERIES TRIM (CONTINUED)

Description	Specify		Non-finished	626	613	612	606	605 619 ¹ 625 693	629 630	643e	622	695
	Part number	Finish										
ME1LH Lever Kit - 996 RMV L/L-BE	044000	.[Finish]	-	\$449.00	\$449.00	\$449.00	\$449.00	\$449.00	-	\$449.00	\$449.00	\$449.00
ME1RH Lever Kit - 996 RMV L/L-BE	044001	.[Finish]	-	\$449.00	\$449.00	\$449.00	\$449.00	\$449.00	-	\$449.00	\$449.00	\$449.00
ME2LH Lever Kit - 996 RMV L/L-BE	044002	.[Finish]	-	\$449.00	\$449.00	\$449.00	\$449.00	\$449.00	-	\$449.00	\$449.00	\$449.00
ME2RH Lever Kit - 996 RMV L/L-BE	044003	.[Finish]	-	\$449.00	\$449.00	\$449.00	\$449.00	\$449.00	-	\$449.00	\$449.00	\$449.00
ME3LH Lever Kit - 996 RMV L/L-BE	044004	.[Finish]	-	\$449.00	\$449.00	\$449.00	\$449.00	\$449.00	-	\$449.00	\$449.00	\$449.00
ME1LH Lever Kit - 996 RMV L/L-BE	044005	.[Finish]	-	-	-	-	-	-	\$449.00	-	-	-
ME1RH Lever Kit - 996 RMV L/L-BE	044006	.[Finish]	-	-	-	-	-	-	\$449.00	-	-	-
ME2LH Lever Kit - 996 RMV L/L-BE	044007	.[Finish]	-	-	-	-	-	-	\$449.00	-	-	-

¹ 619 finish available with device series 98 trims.

PARTS AND ACCESSORIES

605	606	611	612	613	619	622	625	626	626AM	628	629
US3	US4	US9	US10	US10B	US15	US19	US26	US26D	US26DAM	US28	US32
630	630AM	643e	689	691	693	695	706	710	711	721	728
US32D	US32DAM	-	SP28	SP10	SPBLK	SP313	SP4	313	315	US3A	US4A

990/996 SERIES TRIM (CONTINUED)

Description	Specify		Non-finished	626	613	612	606	605	629	643e	622	695
	Part number	Finish						619 ¹ 625 693				
ME2RH Lever Kit - 996 RMV L/L-BE	044008	.[Finish]	-	-	-	-	-	-	\$449.00	-	-	-
ME3 Lever Kit - 996 RMV L/L-BE	044009	.[Finish]	-	-	-	-	-	-	\$449.00	-	-	-
M51 Lever Kit - 996 RMV L/L-BE	114811	.[Finish]	-	\$449.00	\$449.00	\$449.00	\$449.00	\$449.00	-	-	-	\$449.00
M51 Lever Kit - 996 RMV L/L-BE	114813	.[Finish]	-	-	-	-	-	-	\$449.00	-	-	-
M52 Lever Kit - 996 RMV L/L-BE	051921	.[Finish]	-	\$449.00	\$449.00	\$449.00	\$449.00	\$449.00	-	-	-	\$449.00
M52 Lever Kit - 996 RMV L/L-BE	051923	.[Finish]	-	-	-	-	-	-	\$449.00	-	-	-
M53 Lever Kit - 996 RMV L/L-BE	051929	.[Finish]	-	\$449.00	\$449.00	\$449.00	\$449.00	\$449.00	-	-	-	\$449.00
M53 Lever Kit - 996 RMV L/L-BE	051931	.[Finish]	-	-	-	-	-	-	\$449.00	-	-	-
M54 Lever Kit - 996 RMV L/L-BE	114827	.[Finish]	-	\$449.00	\$449.00	\$449.00	\$449.00	\$449.00	-	-	-	\$449.00
M54 Lever Kit - 996 RMV L/L-BE	114829	.[Finish]	-	-	-	-	-	-	\$449.00	-	-	-
M55 Lever Kit - 996 RMV L/L-BE	051937	.[Finish]	-	\$449.00	\$449.00	\$449.00	\$449.00	\$449.00	-	-	-	\$449.00
M55 Lever Kit - 996 RMV L/L-BE	051939	.[Finish]	-	-	-	-	-	-	\$449.00	-	-	-
M56 Lever Kit - 996 RMV L/L-BE	114823	.[Finish]	-	\$449.00	\$449.00	\$449.00	\$449.00	\$449.00	-	-	-	\$449.00
M56 Lever Kit - 996 RMV L/L-BE	114825	.[Finish]	-	-	-	-	-	-	\$449.00	-	-	-
M57 Lever Kit - 996 RMV L/L-BE	051915	.[Finish]	-	-	-	-	-	-	\$449.00	-	-	-
M61LH Lever Kit- 996 RMV L/L-BE	114815	.[Finish]	-	\$449.00	\$449.00	\$449.00	\$449.00	\$449.00	-	-	-	\$449.00
M61LH Lever Kit- 996 RMV L/L-BE	114817	.[Finish]	-	-	-	-	-	-	\$449.00	-	-	-
M61RH Lever Kit- 996 RMV L/L-BE	114819	.[Finish]	-	\$449.00	\$449.00	\$449.00	\$449.00	\$449.00	-	-	-	\$449.00
M61RH Lever Kit- 996 RMV L/L-BE	114821	.[Finish]	-	-	-	-	-	-	\$449.00	-	-	-
M62LH Lever Kit- 996 RMV L/L-BE	051917	.[Finish]	-	-	-	-	-	-	\$449.00	-	-	-
M62RH Lever Kit- 996 RMV L/L-BE	051919	.[Finish]	-	-	-	-	-	-	\$449.00	-	-	-
M63LH Lever Kit- 996 RMV L/L-BE	114843	.[Finish]	-	\$449.00	\$449.00	\$449.00	\$449.00	\$449.00	-	-	-	\$449.00
M63LH Lever Kit- 996 RMV L/L-BE	114845	.[Finish]	-	-	-	-	-	-	\$449.00	-	-	-
M63RH Lever Kit- 996 RMV L/L-BE	114847	.[Finish]	-	\$449.00	\$449.00	\$449.00	\$449.00	\$449.00	-	-	-	\$449.00
M63RH Lever Kit- 996 RMV L/L-BE	114849	.[Finish]	-	-	-	-	-	-	\$449.00	-	-	-
M81 Lever Kit - 996 RMV L/L-BE	051925	.[Finish]	-	\$449.00	\$449.00	\$449.00	\$449.00	\$449.00	-	-	-	\$449.00
M81 Lever Kit - 996 RMV L/L-BE	051927	.[Finish]	-	-	-	-	-	-	\$449.00	-	-	-
M82 Lever Kit - 996 RMV L/L-BE	051933	.[Finish]	-	\$449.00	\$449.00	\$449.00	\$449.00	\$449.00	-	-	-	\$449.00
M82 Lever Kit - 996 RMV L/L-BE	051935	.[Finish]	-	-	-	-	-	-	\$449.00	-	-	-
M83 Lever Kit - 996 RMV L/L-BE	114831	.[Finish]	-	\$449.00	\$449.00	\$449.00	\$449.00	\$449.00	-	-	-	\$449.00
M83 Lever Kit - 996 RMV L/L-BE	114833	.[Finish]	-	-	-	-	-	-	\$449.00	-	-	-
M84 Lever Kit - 996 RMV L/L-BE	114851	.[Finish]	-	\$449.00	\$449.00	\$449.00	\$449.00	\$449.00	-	-	-	\$449.00
M84 Lever Kit - 996 RMV L/L-BE	114853	.[Finish]	-	-	-	-	-	-	\$449.00	-	-	-
M85LH Lever Kit- 996 RMV L/L-BE	114835	.[Finish]	-	\$449.00	\$449.00	\$449.00	\$449.00	\$449.00	-	-	-	\$449.00
M85LH Lever Kit- 996 RMV L/L-BE	114837	.[Finish]	-	-	-	-	-	-	\$449.00	-	-	-
M85RH Lever Kit- 996 RMV L/L-BE	114839	.[Finish]	-	\$449.00	\$449.00	\$449.00	\$449.00	\$449.00	-	-	-	\$449.00
M85RH Lever Kit- 996 RMV L/L-BE	114841	.[Finish]	-	-	-	-	-	-	\$449.00	-	-	-

¹ 619 finish available with device series 98 trims.

PARTS AND ACCESSORIES

605	606	611	612	613	619	622	625	626	626AM	628	629
US3	US4	US9	US10	US10B	US15	US19	US26	US26D	US26DAM	US28	US32
630	630AM	643e	689	691	693	695	706	710	711	721	728
US32D	US32DAM	-	SP28	SP10	SPBLK	SP313	SP4	313	315	US3A	US4A

990/996 SERIES TRIM (CONTINUED)

Description	Specify		Non-finished	626	613	612	606	605, 619, 625, 693	629 630
	Part number	Finish							
Orbit Knob Assembly - 991K	110537	.[Finish]	-	\$178.00	\$208.00	\$283.00	\$236.00	\$300.00	-
Slider Sub-Assembly - 994/996L-R/V	111869	-	\$236.00	-	-	-	-	-	-
Slider Sub-Assembly - 994/996L-M	112462	-	\$236.00	-	-	-	-	-	-
M996 RIM/SV Slider Assembly	47427601	-	\$378.00	-	-	-	-	-	-
990 Screw Package 1-3/4" - 2-1/4" Door	900853	.[Finish]	-	\$42.00	\$42.00	\$42.00	\$42.00	\$42.00	-
991/992/994/996 Screw Package	900920	-	\$19.00	-	-	-	-	-	-
Cam-996	971132	-	\$51.00	-	-	-	-	-	-
392-7 Mounting Pack	900954	.[Finish]	-	\$20.00	-	-	-	-	-
Hex Stud - 990 Trim	956760	-	\$19.00	-	-	-	-	-	-
Pull Grip - 990	972467	.[Finish]	-	-	\$186.00	-	\$153.00	\$249.00	-
Pull Grip - 990	972466	.[Finish]	-	\$186.00	-	-	-	-	-
Thumbpiece - 696/990-M	959575	.[Finish]	-	\$98.00	\$98.00	\$90.00	\$90.00	\$138.00	-
Thumbpiece Axle - 696/990	959603	-	\$19.00	-	-	-	-	-	-
Cylinder Collar - 696/990-M	961267	.[Finish]	-	\$62.00	\$62.00	\$78.00	\$62.00	\$78.00	-
Flat Washer - 992K-DT/NL/BE/992L	963105	-	\$20.00	-	-	-	-	-	-
12-24 x 3/8" UFPHMS - 990NL/DT	963579	-	\$19.00	-	-	-	-	-	-
Retaining Ring - 991K	963767	-	\$19.00	-	-	-	-	-	-
Retaining Ring - 992L	964097	-	\$19.00	-	-	-	-	-	-
10-24 x 1/2" Socket Set Cap Screw	964183	-	\$19.00	-	-	-	-	-	-
Retaining Ring - 991K-DT/NL/BE/992L	964285	-	\$19.00	-	-	-	-	-	-
1/4-20 x 5/8" Socket Set Screw	964353	-	\$19.00	-	-	-	-	-	-
Cylinder Collar - 990-R	965226	.[Finish]	-	\$62.00	\$62.00	\$78.00	\$62.00	\$78.00	-
TP Bracket Screw - 990TP	965237	-	\$18.00	-	-	-	-	-	-
Cylinder Retaining Cup - 990/996 Trim	968201	-	\$30.00	-	-	-	-	-	-
Spring - 991K	969012	-	\$19.00	-	-	-	-	-	-
Thumbpiece Bracket - 990TP	969353	-	\$19.00	-	-	-	-	-	-
Flange Bearing - 991K	970159	-	\$20.00	-	-	-	-	-	-
Thumbpiece - 990TP-R	970488	.[Finish]	-	\$98.00	\$98.00	\$138.00	\$90.00	\$138.00	-
996L-DT/NL Retaining Plate Kit	044020	-	\$178.00	-	-	-	-	-	-
Hex Stud - 991K/992L	971440	-	\$20.00	-	-	-	-	-	-
Lift Spring - 992/994	971573	-	\$16.00	-	-	-	-	-	-
Shear Pin Kit - 992/994/996 w/retaining ring	050611	-	\$19.00	-	-	-	-	-	-
Mounting Stud - 994/996	971585	-	\$19.00	-	-	-	-	-	-
M996 Mort Conv to Motorized Kit	47273112	-	\$1,040.00	-	-	-	-	-	-
M996 R/V/C Conv to Motorized Kit	47273111	-	\$998.00	-	-	-	-	-	-
M996 Wire Harness	CABLE.10038	-	\$69.00	-	-	-	-	-	-
Lever Bushing	050579	-	\$19.00	-	-	-	-	-	-

¹ 619 finish available with device series 98 trims

Z2 SERIES
 33A/35A SERIES
 55 SERIES
 88 SERIES
 98/99 SERIES
 XP98/XP99 SERIES
 94/95 SERIES
 GUARD-X SERIES
 ACCESSORIES / PARTS
 ELECTRICAL / PARTS

PARTS AND ACCESSORIES

605	606	611	612	613	619	622	625	626	626AM	628	629
US3	US4	US9	US10	US10B	US15	US19	US26	US26D	US26DAM	US28	US32
630	630AM	643e	689	691	693	695	706	710	711	721	728
US32D	US32DAM	-	SP28	SP10	SPBLK	SP313	SP4	313	315	US3A	US4A

OPTIONAL TRIM

Description	Specify		Non-finished	626	695 613	612	606	605 625 693
	Part number	Finish						
696/697DT x 330/350 Screw Package 1-3/4" Dr	050142	.[Finish]	-	\$24.00	\$24.00	\$24.00	\$24.00	\$24.00
696/697DT x 330/350 Screw Package 2-1/4" Dr	050143	.[Finish]	-	-	\$24.00	\$24.00	\$24.00	\$24.00
696/697 Cylinder Hardware Assembly 1-3/4" Dr	109369	.[Finish]	-	\$138.00	\$138.00	\$208.00	\$180.00	\$237.00
696/697 Cylinder Hardware Assembly 2-1/4" Dr	109130	.[Finish]	-	\$138.00	\$138.00	\$208.00	\$180.00	\$237.00
696/697 Screw Package 1-3/4" Door	900839	.[Finish]	-	\$19.00	\$19.00	\$19.00	\$19.00	\$19.00
696/697 Screw Package 2-1/4" Door	900840	.[Finish]	-	\$19.00	\$19.00	\$19.00	\$19.00	\$19.00
Pull Grip - 608/696 Trim	972467	.[Finish]	-	-	\$186.00	-	\$153.00	\$249.00
Pull Grip - 608/696 Trim	972466	.[Finish]	-	\$186.00	-	-	-	-
Thumbpiece - 608 Trim	959575	.[Finish]	-	\$98.00	\$98.00	\$90.00	\$90.00	\$138.00
Thumbpiece Axle - 608 Trim	959603	-	\$19.00	-	-	-	-	-
Sex Bolt Extension - 606/608 Trim	960902	-	\$20.00	-	-	-	-	-
Thumbpiece Bracket - 608TP-R/V	960921	-	\$33.00	-	-	-	-	-
3/8" Lockwasher - 606K	963703	-	\$18.00	-	-	-	-	-
Hex Nut - 606K-DT/K-NL	963704	-	\$18.00	-	-	-	-	-
1/4-20 3/4" Socket Set Screw	964355	-	\$19.00	-	-	-	-	-
Thumbpiece Bracket - 608TP-M	965130	-	\$73.00	-	-	-	-	-
Sex Bolt Head - 606/608 Trim	967329	.[Finish]	-	\$24.00	\$24.00	\$24.00	\$24.00	\$24.00
Pull Grip - 697 Trim	968694	.[Finish]	-	\$317.00	\$317.00	\$317.00	\$317.00	\$369.00
Sex Bolt Head - 696/697 Trim	968918	.[Finish]	-	\$24.00	\$24.00	\$24.00	\$24.00	\$24.00
Hex Stud - 696/697 Trim	969091	-	\$19.00	-	-	-	-	-
Sex Bolt Extension - 696/697 Trim	969092	-	\$24.00	-	-	-	-	-
Thumbpiece - 608TP-R	970488	.[Finish]	-	\$98.00	\$98.00	\$138.00	\$90.00	\$138.00
Thumbpiece - 696/697-R/V	970491	.[Finish]	-	\$98.00	\$98.00	\$138.00	\$90.00	\$138.00
334 Cylinder Collar	961267	.[Finish]	-	\$62.00	\$62.00	\$78.00	\$62.00	\$78.00
940 Trim Cam Service Kit	040171	-	\$185.00	-	-	-	-	-
940 Tail Piece Mounting Pkg	900390	-	\$32.00	-	-	-	-	-

CONTROL TRIMS

605	606	611	612	613	619	622	625	626	626AM	628	629
US3	US4	US9	US10	US10B	US15	US19	US26	US26D	US26DAM	US28	US32
630	630AM	643e	689	691	693	695	706	710	711	721	728
US32D	US32DAM	-	SP28	SP10	SPBLK	SP313	SP4	313	315	US3A	US4A

360 SERIES

360 SERIES									
Description	Specify		626	613, 622, 693, 695	629 ¹ 630 ¹	612	606	605, 619, 625, 643e	
	Model number	Finish							
STANDARD LEVER DESIGNS									
Lever, Key unlocks - 33/35A Rim, 33/3527A, 33/3547A	360L ²	[Finish]	\$966.00	\$996.00	\$1,107.00	\$1,039.00	\$924.00	\$1,075.00	
Lever, Blank Escutcheon - 33/35A Rim, 33/3527A, 33/3547A	360L-BE	[Finish]	\$902.00	\$932.00	\$1,043.00	\$975.00	\$860.00	\$1,011.00	
Lever, Dummy - 33/35A Rim, 33/3527A, 33/3547A	360L-DT	[Finish]	\$891.00	\$921.00	\$1,032.00	\$964.00	\$849.00	\$1,000.00	
M COLLECTION LEVER DESIGNS									
Lever, Key unlocks - 33/35A Rim, 33/3527A, 33/3547A	360L ²	[Finish]	\$1,107.00	\$1,107.00	\$1,107.00	\$1,107.00	\$1,107.00	\$1,107.00	
Lever, Blank Escutcheon - 33/35A Rim, 33/3527A, 33/3547A	360L-BE	[Finish]	\$1,043.00	\$1,043.00	\$1,043.00	\$1,043.00	\$1,043.00	\$1,043.00	
Lever, Dummy - 33/35A Rim, 33/3527A, 33/3547A	360L-DT	[Finish]	\$1,033.00	\$1,033.00	\$1,033.00	\$1,033.00	\$1,033.00	\$1,033.00	

¹ 630 lever furnished with 619 trim plate. 629 lever furnished with 625 trim plate. 619 control trim for use on 35A Series device only.

² L function is field-convertible to L-NL.

OPTIONS

STANDARD LEVER DESIGNS	
Standard	06 (furnished standard when lever design is not specified)
Optional - 360	01, 02, 03, 03-SS ¹ , 05, 06-SS ¹ , 07, 12, 16, 17, 17-SS ¹ , 18, Accent (ACC), Asti (AST), Merano (MER), Latitude (LAT), LAT-SS ¹ , Longitude (LON), LON-SS ¹
Special order - E360	01, 02, 03, 05, 07, 12, 16, 17, Latitude (LAT) Special order ☒: 03-SS ¹ , 06-SS ¹ , 17-SS ¹ , 18, Accent (ACC), Asti (AST), LAT-SS ¹ , Longitude (LON), LON-SS ¹ , Merano (MER)
Special order - 643e finish	Special order ☒: 18, Accent (ACC), Asti (AST), Merano (MER).
M COLLECTION LEVER DESIGNS	
Optional - 360	M51, M52, M53, M54, M55, M56, M57 ¹ , M61, M62 ¹ , M63, M81, M82, M83, M84, M85, ME1, ME2, ME3
Optional - E360	M51, M52, M53, M54, M55, M56, M57 ¹ , M61, M62 ¹ , M63, M81, M82, M83, M84, M85, ME1, ME2, ME3
Special order - 643e finish	Special order ☒: M51, M52, M53, M54, M55, M56, M61, M62 ¹ , M63, M81, M82, M83, M84, M85.
HANDING	
<ul style="list-style-type: none"> Handing is field reversible and furnished RHR if not specified on all lever designs except 12, AST, MER, ACC, M61, M62, M63, M85 Specify handing RHR or LHR for lever designs 12, AST, MER, ACC, M61, M62, M63, M85, ME1, ME2 	

KNURLED LEVER	Specify (Suffix)	Price adjustment
Available standard on 03, 06, ME1, ME2, and ME3 lever designs. Specify suffix KN (06-KN).	KN	\$150.00
Available for special order on 02, 17, M51, M52, and M81 lever designs. Specify suffix KN (02-KN). ☒		\$228.00

ANTI-MICROBIAL FINISH	Specify (Suffix)	Price adjustment
626-AM - Antimicrobial Coating on 626 finish available standard.	AM	\$45.00
630-AM - Antimicrobial Coating on 630 finish available for special order on lever designs 03-SS, 06-SS, 17-SS, LAT-SS, LON-SS, M57, M62.		\$45.00

¹ Stainless Steel Levers (SS) - are available in 630 or 629. 619 control trim for use on 35A Series device only.

☒ Consult factory for lead time.

For other possible trim applications not shown, consult Von Duprin.

CONTROL TRIMS

605	606	611	612	613	619	622	625	626	626AM	628	629
US3	US4	US9	US10	US10B	US15	US19	US26	US26D	US26DAM	US28	US32
630	630AM	643e	689	691	693	695	706	710	711	721	728
US32D	US32DAM	-	SP28	SP10	SPBLK	SP313	SP4	313	315	US3A	US4A

360 SERIES

OPTIONS

SOLID WOOD OR COMPOSITE DOORS	Specify (Suffix)	Price adjustment
Required when used on solid wood or composite doors	33-WDA	\$75.00

DOOR THICKNESS ² >2-1/4" - 4-1/4"	Specify (Suffix)	Price adjustment
360L, LBE	Door Thickness > 2-1/4" - <= 4-1/4"	\$185.00
360L-DT		\$126.00

ELECTRIC UNLOCKING ²	Specify (Suffix)	Price adjustment
<ul style="list-style-type: none"> Electric Unlocking of outside trim for use on all device types except mortise lock devices Must be furnished LBE functions only, specify handing. Prefix trim "E" (example E360) Specify Fail Safe (FS) or Fail Secure (FSE). 24VDC furnished standard, 12VDC available through special order. ⓘ 	E	\$909.00

¹ Stainless Steel Levers (SS) - are available in 630 or 629 . 619 control trim for use on 35A series device only.

² When ordering an E360 for door thickness Door Thickness > 2-1/4" - <= 4-1/4", consult factory for lead time.

ⓘ Consult factory for lead time.

370 SERIES

370 SERIES							
Description	Specify		626	613 622 ⓘ 693	612	606	605 619 ⓘ 625 643e
	Model number	Finish					
Lever, Key unlocks - 5547/8847-F	371L	.[Finish]	\$1,045.00	\$1,031.00	\$1,045.00	\$894.00	\$1,151.00
Lever, Blank Escutcheon - 5547/8847-F	371L-BE	.[Finish]	\$998.00	\$984.00	\$998.00	\$847.00	\$1,104.00
Lever, Key unlocks - 88 Rim, 8827/8875	373L	.[Finish]	\$972.00	\$958.00	\$972.00	\$821.00	\$1,078.00
Lever, Blank Escutcheon - 88 Rim, 8827/8875	373L-BE	.[Finish]	\$922.00	\$908.00	\$922.00	\$771.00	\$1,028.00
Lever, Dummy - 88 Rim, 8827/8875	373L-DT	.[Finish]	\$895.00	\$881.00	\$895.00	\$744.00	\$1,001.00
Lever, Key unlocks - 5575	375L	.[Finish]	\$1,242.00	\$1,228.00	\$1,242.00	\$1,091.00	\$1,348.00
Lever, Blank Escutcheon - 5575	375L-BE	.[Finish]	\$1,185.00	\$1,171.00	\$1,185.00	\$1,034.00	\$1,291.00
Lever, Dummy - 5575	375L-DT	.[Finish]	\$1,167.00	\$1,153.00	\$1,167.00	\$1,016.00	\$1,273.00
Lever, Key unlocks - 5547	376L	.[Finish]	\$1,233.00	\$1,219.00	\$1,233.00	\$1,082.00	\$1,339.00
Lever, Blank Escutcheon - 5547/8847-F	376L-BE	.[Finish]	\$1,185.00	\$1,171.00	\$1,185.00	\$1,034.00	\$1,291.00
Lever, WD - Key unlocks - 5547WDC	376WDC-L	.[Finish]	\$1,233.00	\$1,219.00	\$1,233.00	\$1,082.00	\$1,339.00
Lever, WD, Blank Escutcheon - 5547WDC	376WDC-L-BE	.[Finish]	\$1,185.00	\$1,171.00	\$1,185.00	\$1,034.00	\$1,291.00
Lever, Key Unlocks - 237	378L	.[Finish]	\$1,039.00	\$1,025.00	\$1,039.00	\$888.00	\$1,145.00
Lever, Blank Escutcheon - 237	378L-BE	.[Finish]	\$969.00	\$955.00	\$969.00	\$818.00	\$1,075.00
Lever, Key Unlocks - 55 Rim	379L	.[Finish]	\$1,263.00	\$1,249.00	\$1,263.00	\$1,112.00	\$1,369.00
Lever, Blank Escutcheon - 55 Rim	379L-BE	.[Finish]	\$1,212.00	\$1,198.00	\$1,212.00	\$1,061.00	\$1,318.00

ⓘ Consult factory for lead time.

CONTROL TRIMS

370 SERIES

605	606	611	612	613	619	622	625	626	626AM	628	629
US3	US4	US9	US10	US10B	US15	US19	US26	US26D	US26DAM	US28	US32
630	630AM	643e	689	691	693	695	706	710	711	721	728
US32D	US32DAM	-	SP28	SP10	SPBLK	SP313	SP4	313	315	US3A	US4A

OPTIONS

LEVER DESIGNS	
Standard	06 (furnished standard when lever design is not specified)
Optional	01, 02, 03, 07, 12, 16, 17, ASTI
Special order [ⓧ]	05, 18

HANDING	
Requires handing, specify RHR or LHR	

KNURLED LEVER	Specify (Suffix)	Price adjustment
Available standard on 02, 03, 06, 07, and 17 lever designs. Specify suffix KN (06-KN).	KN	\$150.00

ANTI-MICROBIAL FINISH	Specify (Suffix)	Price adjustment
Antimicrobial Coating available in 626, use suffix-AM when ordering. Example 626-AM	AM	\$45.00

SOLID WOOD OR COMPOSITE DOORS	Specify (Suffix)	Price adjustment
Required when used on solid wood or composite doors	10WDA	\$75.00

ELECTRIC UNLOCKING	Specify (Suffix)	Price adjustment
<ul style="list-style-type: none"> Electric Unlocking of outside trim for use on all device types except mortise lock devices Available for 373. For all other 370 Controls, available through special order. Must be furnished LBE functions only, specify handing. Prefix trim "E" (example E373) Specify Fail Safe (FS) or Fail Secure (FSE). 24VDC furnished standard, 12VDC available through special order. [ⓧ] 	E	\$909.00

[ⓧ] Consult factory for lead time.

PARTS AND ACCESSORIES

360/370 SERIES CONTROLS									
Description	Model	Specify		Non-finished	613 626	606	612	605, 619, ¹ 625, 693	629 630
		Part number	Finish						
Rod Member Kit 1-3/4" Door	371	109126	-	\$173.00	-	-	-	-	-
Rod Member Kit 2-1/4" Door	371	109127	-	\$173.00	-	-	-	-	-
Rod Member Kit 1-3/4" Door	377	109132	.[Finish]	-	\$208.00	\$208.00	\$241.00	\$277.00	-
Rod Member Kit 2-1/4" Door	377	109133	.[Finish]	-	\$208.00	\$208.00	\$241.00	\$277.00	-
Rod Member Kit 1-3/4" Door	374	109366	.[Finish]	-	\$289.00	\$289.00	\$289.00	\$369.00	-
Rod Member Kit 2-1/4" Door	374	109367	.[Finish]	-	\$289.00	\$289.00	\$289.00	\$369.00	-
Rod Member Kit 1-3/4" Door	376	109112	-	\$109.00	-	-	-	-	-
Rod Member Kit 2" Door	376	900582	.[Finish]	-	\$203.00	\$203.00	\$203.00	\$203.00	-

¹ 619 finish available with Series 35 and 98 controls only.

22 SERIES
 33A/35A SERIES
 55 SERIES
 88 SERIES
 98/99 SERIES
 XP98/XP99 SERIES
 94/95 SERIES
 GUARD-X SERIES
 ACCESSORIES / PARTS
 ELECTRICAL / PARTS

PARTS AND ACCESSORIES

605	606	611	612	613	619	622	625	626	626AM	628	629
US3	US4	US9	US10	US10B	US15	US19	US26	US26D	US26DAM	US28	US32
630	630AM	643e	689	691	693	695	706	710	711	721	728
US32D	US32DAM	-	SP28	SPI0	SPBLK	SP313	SP4	313	315	US3A	US4A

360/370 SERIES CONTROLS

Description	Model	Specify		Non-finished	613 626	606	612	605, 619, ¹ 625, 693	629 630
		Part number	Finish						
Rod Member Kit 2-1/4" Door	376	109115	-	\$203.00	-	-	-	-	-
Rod Member Kit 1-3/4" - 2" Door	376WDC	900558	-	\$188.00	-	-	-	-	-
Rod Member Kit 2-1/4" Door	376WDC	900559	-	\$277.00	-	-	-	-	-
Rod Member Kit 1-3/4" Door	237	112843	-	\$153.00	-	-	-	-	-
#01 Lever Kit	360	050001	.[Finish]	-	\$308.00	\$308.00	\$347.00	\$420.00	-
#02 Lever Kit	360	050002	.[Finish]	-	\$308.00	\$308.00	\$347.00	\$420.00	-
#03 Lever Kit	360	050003	.[Finish]	-	\$308.00	\$308.00	\$347.00	\$420.00	-
#05 Lever Kit	360	050008	.[Finish]	-	\$308.00	\$308.00	\$347.00	\$420.00	-
#06 Lever Kit	360	050006	.[Finish]	-	\$308.00	\$308.00	\$347.00	\$420.00	-
#07 Lever Kit	360	050007	.[Finish]	-	\$308.00	\$308.00	\$347.00	\$420.00	-
#12 Lever RHR Kit	360	050012	.[Finish]	-	\$308.00	\$308.00	\$347.00	\$420.00	-
#12 Lever LHR Kit	360	050013	.[Finish]	-	\$308.00	\$308.00	\$347.00	\$420.00	-
#16 Lever Kit	360	050009	.[Finish]	-	\$308.00	\$308.00	\$347.00	\$420.00	-
#17 Lever Kit	360	050017	.[Finish]	-	\$308.00	\$308.00	\$347.00	\$420.00	-
#18 Lever Kit	360	050010	.[Finish]	-	\$308.00	\$308.00	\$347.00	\$420.00	-
#01 Lever Kit	371/373/375/378	050750	.[Finish]	-	\$308.00	\$308.00	\$347.00	\$420.00	-
#01 DT Lever Kit	373/375	050751	.[Finish]	-	\$308.00	\$308.00	\$347.00	\$420.00	-
#02 Lever Kit	371/373/375/378	050752	.[Finish]	-	\$308.00	\$308.00	\$347.00	\$420.00	-
#02 DT Lever Kit	373/375	050753	.[Finish]	-	\$308.00	\$308.00	\$347.00	\$420.00	-
#03 Lever Kit	371/373/375/378	050754	.[Finish]	-	\$308.00	\$308.00	\$347.00	\$420.00	-
#03 DT Lever Kit	373/375	050755	.[Finish]	-	\$308.00	\$308.00	\$347.00	\$420.00	-
#06 Lever Kit	371/373/375/378	050756	.[Finish]	-	\$308.00	\$308.00	\$347.00	\$420.00	-
#06 DT Lever Kit	373/375	050757	.[Finish]	-	\$308.00	\$308.00	\$347.00	\$420.00	-
#07 Lever Kit	371/373/375/378	050758	.[Finish]	-	\$308.00	\$308.00	\$347.00	\$420.00	-
#07 DT Lever Kit	373/375	050759	.[Finish]	-	\$308.00	\$308.00	\$347.00	\$420.00	-
#17 Lever Kit	371/373/375/378	050760	.[Finish]	-	\$308.00	\$308.00	\$347.00	\$420.00	-
#17 DT Lever Kit	373/375	050761	.[Finish]	-	\$308.00	\$308.00	\$347.00	\$420.00	-
#12 Lever RHR Kit	371/373/375/378	050762	.[Finish]	-	\$308.00	\$308.00	\$347.00	\$420.00	-
#12 DT Lever RHR Kit	373/375	050763	.[Finish]	-	\$308.00	\$308.00	\$347.00	\$420.00	-
#12 Lever LHR Kit	371/373/375/378	050764	.[Finish]	-	\$308.00	\$308.00	\$347.00	\$420.00	-
#12 DT Lever LHR Kit	373/375	050765	.[Finish]	-	\$308.00	\$308.00	\$347.00	\$420.00	-
LAT Lever Kit	360	051871	.[Finish]	-	\$308.00	\$308.00	\$347.00	\$420.00	-
LON Lever Kit	360	051873	.[Finish]	-	\$308.00	\$308.00	\$347.00	\$420.00	-
M51 Lever Kit	360	114810	.[Finish]	-	\$449.00	\$449.00	\$449.00	\$449.00	-
M51 Lever Kit	360	114812	.[Finish]	-	-	-	-	-	\$449.00
M52 Lever Kit	360	051920	.[Finish]	-	\$449.00	\$449.00	\$449.00	\$449.00	-
M52 Lever Kit	360	051922	.[Finish]	-	-	-	-	-	\$449.00
M53 Lever Kit	360	051928	.[Finish]	-	\$449.00	\$449.00	\$449.00	\$449.00	-
M53 Lever Kit	360	051930	.[Finish]	-	-	-	-	-	\$449.00
M54 Lever Kit	360	114826	.[Finish]	-	\$449.00	\$449.00	\$449.00	\$449.00	-
M54 Lever Kit	360	114828	.[Finish]	-	-	-	-	-	\$449.00

¹ 619 finish available with Series 35 and 98 controls only.

PARTS AND ACCESSORIES

605	606	611	612	613	619	622	625	626	626AM	628	629
US3	US4	US9	US10	US10B	US15	US19	US26	US26D	US26DAM	US28	US32
630	630AM	643e	689	691	693	695	706	710	711	721	728
US32D	US32DAM	-	SP28	SP10	SPBLK	SP313	SP4	313	315	US3A	US4A

360/370 SERIES CONTROLS

Description	Model	Specify		Non-finished	613 626	606	612	605, 619, ¹ 625, 693	629 630
		Part number	Finish						
M55 Lever Kit	360	051936	.[Finish]	-	\$449.00	\$449.00	\$449.00	\$449.00	-
M55 Lever Kit	360	051938	.[Finish]	-	-	-	-	-	\$449.00
M56 Lever Kit	360	114822	.[Finish]	-	\$449.00	\$449.00	\$449.00	\$449.00	-
M56 Lever Kit	360	114824	.[Finish]	-	-	-	-	-	\$449.00
M57 Lever Kit	360	051914	.[Finish]	-	-	-	-	-	\$449.00
M61LH Lever Kit	360	114814	.[Finish]	-	\$449.00	\$449.00	\$449.00	\$449.00	-
M61LH Lever Kit	360	114816	.[Finish]	-	-	-	-	-	\$449.00
M61RH Lever Kit	360	114818	.[Finish]	-	\$449.00	\$449.00	\$449.00	\$449.00	-
M61RH Lever Kit	360	114820	.[Finish]	-	-	-	-	-	\$449.00
M62LH Lever Kit	360	051916	.[Finish]	-	-	-	-	-	\$449.00
M62RH Lever Kit	360	051918	.[Finish]	-	-	-	-	-	\$449.00
M63LH Lever Kit	360	114842	.[Finish]	-	\$449.00	\$449.00	\$449.00	\$449.00	-
M63LH Lever Kit	360	114844	.[Finish]	-	-	-	-	-	\$449.00
M63RH Lever Kit	360	114846	.[Finish]	-	\$449.00	\$449.00	\$449.00	\$449.00	-
M63RH Lever Kit	360	114848	.[Finish]	-	-	-	-	-	\$449.00
M81 Lever Kit	360	051924	.[Finish]	-	\$449.00	\$449.00	\$449.00	\$449.00	-
M81 Lever Kit	360	051926	.[Finish]	-	-	-	-	-	\$449.00
M82 Lever Kit	360	051932	.[Finish]	-	\$449.00	\$449.00	\$449.00	\$449.00	-
M82 Lever Kit	360	051934	.[Finish]	-	-	-	-	-	\$449.00
M83 Lever Kit	360	114830	.[Finish]	-	\$449.00	\$449.00	\$449.00	\$449.00	-
M83 Lever Kit	360	114832	.[Finish]	-	-	-	-	-	\$449.00
M84 Lever Kit	360	114850	.[Finish]	-	\$449.00	\$449.00	\$449.00	\$449.00	-
M84 Lever Kit	360	114852	.[Finish]	-	-	-	-	-	\$449.00
M85LH Lever Kit	360	114834	.[Finish]	-	\$449.00	\$449.00	\$449.00	\$449.00	-
M85LH Lever Kit	360	114836	.[Finish]	-	-	-	-	-	\$449.00
M85RH Lever Kit	360	114838	.[Finish]	-	\$449.00	\$449.00	\$449.00	\$449.00	-
M85RH Lever Kit	360	114840	.[Finish]	-	-	-	-	-	\$449.00
#03 SS Lever Kit	360	051861	.[Finish]	-	-	-	-	-	\$420.00
#06 SS Lever Kit	360	051863	.[Finish]	-	-	-	-	-	\$420.00
#17 SS Lever Kit	360	051865	.[Finish]	-	-	-	-	-	\$420.00
LAT SS Lever Kit	360	051867	.[Finish]	-	-	-	-	-	\$420.00
LON SS Lever Kit	360	051869	.[Finish]	-	-	-	-	-	\$420.00
Thumbturn Kit	374/376/377	050592	.[Finish]	-	\$294.00	\$294.00	\$294.00	\$454.00	-
Thumbturn Kit	360	050593	.[Finish]	-	\$294.00	\$294.00	\$294.00	\$454.00	-
Backplate	360	050595	-	\$31.00	-	-	-	-	-
Backplate LHR	371/3/4/5/6/7/8	050596	-	\$31.00	-	-	-	-	-
Backplate RHR	371/3/4/5/6/7/8	050597	-	\$31.00	-	-	-	-	-
Backplate LDT	373/375	050598	-	\$31.00	-	-	-	-	-

¹ 619 finish available with Series 35 and 98 controls only.

PARTS AND ACCESSORIES

605	606	611	612	613	619	622	625	626	626AM	628	629
US3	US4	US9	US10	US10B	US15	US19	US26	US26D	US26DAM	US28	US32
630	630AM	643e	689	691	693	695	706	710	711	721	728
US32D	US32DAM	-	SP28	SP10	SPBLK	SP313	SP4	313	315	US3A	US4A

360/370 SERIES CONTROLS

Description	Model	Specify		Non-finished	613 626	606	612 622 693	605 625
		Part number	Finish					
NL Cylinder Plate	371/3/4/5/6/7/8	050599	-	\$24.00	-	-	-	-
TL Cylinder Plate	371/3/4/5/6/7/8	050600	-	\$24.00	-	-	-	-
Cylinder Lock Nut & Washer	371/3/4/5/6/7/8	109111	-	\$31.00	-	-	-	-
Cylinder Locknut	360	050526	-	\$20.00	-	-	-	-
Cylinder Lock Pkg/2	371/3/4/5/6/7/8	090090	-	\$19.00	-	-	-	-
Cylinder Auxiliary Package	360	900622	-	\$42.00	-	-	-	-
Lever Adjustment Block	371/3/4/5/6/7/8	050576	-	\$19.00	-	-	-	-
Lever Bushing	360L	050579	-	\$19.00	-	-	-	-
Lever Bushing	371/373/375/378	050601	-	\$19.00	-	-	-	-
Lever Control Spring LHR Pkg/4	371/373/375/378	090091	-	\$24.00	-	-	-	-
Lever Control Spring RHR Pkg/4	371/373/375/378	090092	-	\$24.00	-	-	-	-
Lever Return Spring Pkg/2	360L/L-BE	090093	-	\$24.00	-	-	-	-
Lever Shaft Lock	371/373/375/378	050602	-	\$19.00	-	-	-	-
Lever Spindle	373	967480	-	\$19.00	-	-	-	-
Lever Stop Block	373/375	050603	-	\$19.00	-	-	-	-
Mounting Stud Pkg/2	360	090094	-	\$19.00	-	-	-	-
Mounting Stud Pkg/2	371/373/378	090095	-	\$19.00	-	-	-	-
Mounting Stud Pkg/2	374/376/377	090096	-	\$19.00	-	-	-	-
Cam - Input	360L/L-BE	050604	-	\$18.00	-	-	-	-
Cam - Output	360	050605	-	\$45.00	-	-	-	-
Cam - Vertical Rod	371/374/376/377	050606	-	\$42.00	-	-	-	-
Cam Retaining Screw (Pkg/4)	371/373/375/378	090097	-	\$19.00	-	-	-	-
Dogging Spring and Guide Kit	371/3/4/5/6/7/8	050607	-	\$19.00	-	-	-	-
Locking Member	360	050608	-	\$55.00	-	-	-	-
Mortise Adaptor	373/375	050609	-	\$70.00	-	-	-	-
Pin - Spirol 3/32 x 19/32 Pkg/4	373/375	090098	-	\$19.00	-	-	-	-
Shear Pin Kit	360	050611	-	\$19.00	-	-	-	-
Pine Tree Clip Pkg/10	360	090099	-	\$18.00	-	-	-	-
Rub Plate	374/377	050612	-	-	\$109.00	\$118.00	\$118.00	\$118.00
Short Arm Hex Wrench 1/8"	374/377	050613	-	\$20.00	-	-	-	-
Short Hex Key 3/32"	371/376	050614	-	\$19.00	-	-	-	-
Socket Set Screw 1/4-20 x 1/4	374/377	090100	-	\$19.00	-	-	-	-
Socket Set Screw 10-32 x 1/4 Pkg/10	360	090101	-	\$19.00	-	-	-	-
Spring - Locking Torsion	360	050615	-	\$16.00	-	-	-	-
Tailpiece	360	050587	-	\$17.00	-	-	-	-
Tailpiece Guide Pkg/10	360	050156	-	\$30.00	-	-	-	-
Tailpiece and screw pkg 2-1/4" - 2-3/4"	360	041000	-	\$266.00	-	-	-	-
Tailpiece and screw pkg 2-3/4" - 3-1/4"	360	041001	-	\$266.00	-	-	-	-
Tailpiece and screw pkg 3-1/4" - 3-3/4"	360	041002	-	\$266.00	-	-	-	-
Tailpiece and screw pkg 3-3/4" - 4-1/4"	360	041003	-	\$266.00	-	-	-	-

PARTS AND ACCESSORIES

605	606	611	612	613	619	622	625	626	626AM	628	629
US3	US4	US9	US10	US10B	US15	US19	US26	US26D	US26DAM	US28	US32
630	630AM	643e	689	691	693	695	706	710	711	721	728
US32D	US32DAM	-	SP28	SP10	SPBLK	SP313	SP4	313	315	US3A	US4A

360/370 SERIES CONTROLS

Description	Model	Specify		Non-finished	613 626	606	612 622 693	605 625
		Part number	Finish					
Thumbturn Control Spring & Washer Kit	374/376/377	050616	-	\$24.00	-	-	-	-
Thumbturn Sleeve	374/376/377	050619	-	\$57.00	-	-	-	-
Washer - Bearing	371/3/4/5/6/7/8	050621	-	\$42.00	-	-	-	-
Washer - Locking Pkg/10	371/373/375	090102	-	\$19.00	-	-	-	-
Washer - Wave Spring Pkg/10	360/371/373/375/378	090103	-	\$18.00	-	-	-	-
Screw Package 1-3/4" Dr	371/373/378	900807	.[Finish]	-	\$31.00	\$31.00	\$31.00	\$31.00
Screw Package 2-1/4" Dr	371/373/378	900808	.[Finish]	-	\$42.00	\$42.00	\$42.00	\$42.00
Screw Package 1-3/4" Dr	374/376/377	900809	.[Finish]	-	\$31.00	\$31.00	\$31.00	\$31.00
Screw Package 2-1/4" Dr	374/376/377	900810	.[Finish]	-	\$42.00	\$42.00	\$42.00	\$42.00
Screw Package 1-3/4" Dr	375	900883	.[Finish]	-	\$31.00	\$31.00	\$31.00	\$31.00
Screw Package 2-1/4" Dr	375	900884	.[Finish]	-	\$42.00	\$42.00	\$42.00	\$42.00
WDC Cover Plate 1-3/4"	376T-WDC	900555	.[Finish]	-	\$71.00	\$90.00	\$166.00	\$166.00
WDC Cover Plate 2-1/4"	376T-WDC	900556	.[Finish]	-	\$71.00	\$90.00	\$166.00	\$166.00
379L Spindle	379	47562257	-	\$59.00	-	-	-	-

ELECTRICAL / PARTS ACCESSORIES / PARTS GUARD-X SERIES 94/95 SERIES XP98/XP99 SERIES 98/99 SERIES 88 SERIES 55 SERIES 33A/35A SERIES 22 SERIES

CYLINDER CONTROLS

605	606	611	612	613	619	622	625	626	626AM	628	629
US3	US4	US9	US10	US10B	US15	US19	US26	US26D	US26DAM	US28	US32
630	630AM	643e	689	691	693	695	706	710	711	721	728
US32D	US32DAM	-	SP28	SP10	SPBLK	SP313	SP4	313	315	US3A	US4A

THUMBTURNS

Description	Specify		613, 622 ¹ , 626, 693, 695	612	606	605 625 643e	619
	Model number	Finish					
Thumbturn - 33/35A Rim	360T	.[Finish]	\$1,046.00	\$1,126.00	\$901.00	\$1,126.00	\$1,126.00
Thumbturn, Blank Escutcheon - 33/35A Rim	360T-BE	.[Finish]	\$989.00	\$1,069.00	\$844.00	\$1,069.00	\$1,069.00
Thumbturn - 33/3527A, 98/9927	374T	.[Finish]	\$1,046.00	\$1,126.00	\$901.00	\$1,126.00	\$1,126.00
Thumbturn, Blank Escutcheon - 33/3527A, 98/9927	374T-BE	.[Finish]	\$989.00	\$1,069.00	\$844.00	\$1,069.00	\$1,069.00
Thumbturn - 33/3547A, 5547, 8847-F	376T	.[Finish]	\$1,046.00	\$1,126.00	\$901.00	\$1,126.00	\$1,126.00
Thumbturn, Blank Escutcheon - 33/3547A, 5547, 8847-F	376T-BE	.[Finish]	\$989.00	\$1,069.00	\$844.00	\$1,069.00	\$1,069.00
Thumbturn, WD - 33A/35A/55/98/9947WDC	376WDC-T	.[Finish]	\$1,046.00	\$1,126.00	\$901.00	\$1,126.00	\$1,126.00
Thumbturn, Blank Escut., WD - 33A/35A/55/98/9947WDC	376WDC-T-BE	.[Finish]	\$989.00	\$1,069.00	\$844.00	\$1,069.00	\$1,069.00
Thumbturn - 8827, WS98/9927	377T	.[Finish]	\$1,048.00	\$1,128.00	\$903.00	\$1,128.00	-
Thumbturn, Blank Escutcheon - 8827	377T-BE	.[Finish]	\$989.00	\$1,069.00	\$844.00	\$1,069.00	-

¹ 622 finish only available on 376 and 377 model numbers.

OPTIONS

ANTI-MICROBIAL FINISH	Specify (Suffix)	Price adjustment
Antimicrobial Coating available in 626, use suffix-AM when ordering. Example 626-AM	AM	\$45.00
SOLID WOOD OR COMPOSITE DOORS	Specify (Suffix)	Price adjustment
Required with 370 series lever control trim when used on solid wood or composite doors	10WDA	\$75.00
Required with 360 series lever control trim when used on solid wood or composite doors	33-WDA	\$75.00
ELECTRIC UNLOCKING	Specify (Suffix)	Price adjustment
<ul style="list-style-type: none"> E360/E370 Cylinder Controls - Electric Unlocking of outside trim for use on all vertical device types. Must be furnished T-BE or TL-BE functions only Prefix trim "E" (example E373) Specify Fail Safe (FS) and Fail Secure (FSE). 24VDC furnished standard, 12VDC available through special order 	E	\$909.00

☞ Consult factory for lead time.

BLANK PLATES

Description	Specify		613 626 693	612	606	605 625 643e	619
	Model number	Finish					
Blank Plate - 33A/35A Rim, 33/3527A, 33/3547A	360EO	.[Finish]	\$487.00	\$509.00	\$421.00	\$524.00	\$524.00
Blank Plate - 88, 8827, 8875	373EO	.[Finish]	\$487.00	\$509.00	\$421.00	\$524.00	-
Blank Plate - 33/3527A, 98/9927	374EO	.[Finish]	\$487.00	\$509.00	\$421.00	\$524.00	\$524.00
Blank Plate - 3347, 8847-F	376EO	.[Finish]	\$487.00	\$509.00	\$421.00	\$524.00	-

COVER PLATES, CYLINDERS AND GLASS BEAD KITS

605	606	611	612	613	619	622	625	626	626AM	628	629
US3	US4	US9	US10	US10B	US15	US19	US26	US26D	US26DAM	US28	US32
630	630AM	643e	689	691	693	695	706	710	711	721	728
US32D	US32DAM	-	SP28	SP10	SPBLK	SP313	SP4	313	315	US3A	US4A

COVER PLATES									
Description	Specify		689 695	613 626	630	612	606	605, 693, 625, 619, 622	
	Model number	Finish							
370 Series Controls on Wood Doors	10WDA	.[Finish]	—	\$75.00	—	\$75.00	\$75.00	\$75.00	
360 Series Controls on Wood Doors	33A-WDA	.[Finish]	—	\$75.00	—	\$75.00	\$75.00	\$75.00	
5547WDC Scalp Plate	5547WDC	.[Finish]	—	\$228.00	\$228.00	\$236.00	\$228.00	\$239.00	
9947WDC Scalp Plate	9947WDC	.[Finish]	—	\$93.00	\$57.00	\$93.00	\$93.00	\$179.00	
33A/35A/98/9950WDC Cover Plate	50WDC	.[Finish]	\$93.00	—	\$93.00	\$93.00	\$93.00	\$93.00	
22 Rim Device	229	.[Finish]	\$149.00	—	—	—	—	—	
5575 Device on Wood Doors	589	.[Finish]	—	\$227.00	—	\$307.00	\$264.00	\$283.00	
88 Rim Device	882	.[Finish]	—	\$223.00	—	—	\$192.00	\$248.00	
88 Rim/8827 Pairs with ANSI 161 door cutout	887	.[Finish]	—	\$223.00	—	—	\$192.00	—	
8875 or 8827 with ANSI 161 door cutout	888	.[Finish]	—	\$223.00	—	—	\$192.00	—	
373L Control with Sexbolts - specify device type R, M or V	889	.[Finish]	—	\$335.00	—	\$339.00	\$318.00	\$352.00	
98/99 Rim Device	997	.[Finish]	\$149.00	—	—	\$149.00	\$149.00	—	

CYLINDERS						
Description	Specify		606, 612, 613, 626			
	Model number	Finish				
Mortise 1-1/4" - 20-001 XQ11-949	3215	.[Finish]	\$128.00			
Rim	3216	.[Finish]	\$128.00			

Note: Custom keying is not available

GLASS BEAD KITS						
Description	Specify		Sprayed finish to match 606, 612, 622, 689, 695			
	Model number	Finish				
1/4" 98/99 Rim/Mortise	98/99GBK-R/M	.[Finish]	\$98.00			
1/4" 98/99 Concealed Vertical	98/99GBK-CV	.[Finish]	\$98.00			
1/4" 98/99 Concealed Vertical for Wood Doors	98/99GBK-CV-WDC	.[Finish]	\$98.00			
1/4" 98/99 Surface Vertical	98/99GBK-SV	.[Finish]	\$140.00			
1/4" 98/99 Rim used with 499-F Strike	98/99GBK-R-499F	.[Finish]	\$140.00			
1/4" XP98/99 Rim/Mortise	XP98/99GBK-R/M	.[Finish]	\$160.00			
1/4" XP98/99 Rim used with 954 Strike	XP98/99GBK-R-954	.[Finish]	\$160.00			
1/4" 33A/35A Rim	33A/35A-GBK-R	.[Finish]	\$98.00			
1/4" 33A/35A Surface Vertical	33A/35A-GBK-SV	.[Finish]	\$140.00			
1/4" 33A/35A Concealed Vertical	33A/35A-GBK-CV	.[Finish]	\$98.00			
1/4" 22 Rim	22GBK-R	.[Finish]	\$98.00			
1/4" 22 Surface Vertical	22GBK-SV	.[Finish]	\$140.00			
1/4" 22 Rim used with 499-F Strike	22GBK-R-499F	.[Finish]	\$140.00			

MULLIONS

605	606	611	612	613	619	622	625	626	626AM	628	629
US3	US4	US9	US10	US10B	US15	US19	US26	US26D	US26DAM	US28	US32
630	630AM	643e	689	691	693	695	706	710	711	721	728
US32D	US32DAM	-	SP28	SP10	SPBLK	SP313	SP4	313	315	US3A	US4A

STEEL MULLIONS

Description	For openings up to:	With KR option for openings up to:	Specify		622, 689, 693, 695
			Model number	Finish	
Prepped for two 1606 Strikes - If 1606 strikes are not specified on your order, two 1606 strikes will be added per mullion. Each 1606 strike is \$104.00 list.	7' 2"	7' 6"	1654	.[Finish]	\$862.00
	8' 2"	8' 6"			\$933.00
	10' 2"	10' 6"			\$1,078.00
Prepped for two 4263 Monitor Strikes	7' 2"	7' 6"	4754	.[Finish]	\$1,194.00
	8' 2"	8' 6"			\$1,261.00
	10' 2"	10' 6"			\$1,400.00
Prepped for one 299 strike and one 6111 Electric Strike. Advise Handing of Electric Strike Prep.	7' 2"	7' 6"	4854	.[Finish]	\$1,194.00
	8' 2"	8' 6"			\$1,261.00
	10' 2"	10' 6"			\$1,400.00
Prepped for two 299 Strikes	7' 2"	7' 6"	4954	.[Finish]	\$862.00
	8' 2"	8' 6"			\$933.00
	10' 2"	10' 6"			\$1,078.00
Prepped for two 909 Strikes, for the XP device.	7' 2"	7' 6"	4954-XP	.[Finish]	\$862.00
	8' 2"	8' 6"			\$933.00
	10' 2"	10' 6"			\$1,078.00
Prepped for one 499F and one 6111 Electric Strike or one 268 Strike and one 6111 Electric Strike. Advise handing of Electric Strike Prep.	7' 3"	7' 5"	9854 ¹	.[Finish]	\$1,664.00
	8' 3"	8' 5"			\$1,734.00
	10' 3"	10' 5"			\$1,876.00
Prepped for two 499F or 268 Strikes	7' 3"	7' 5"	9954 ¹	.[Finish]	\$1,337.00
	8' 3"	8' 5"			\$1,405.00
	10' 3"	10' 5"			\$1,546.00
Prepped for two 954 Strikes, for the XP device.	7' 3"	7' 5"	9954-XP	.[Finish]	\$1,337.00
	8' 3"	8' 5"			\$1,405.00
	10' 3"	10' 5"			\$1,546.00
Hurricane wind and impact-rated Mullion (furnished blank)	8'0"		HH9954	.[Finish]	\$2,051.00

¹ When used with 22, 98 or 99 Series Rim Fire Devices or 98/9957-F Devices, and 499F strikes are not ordered with devices, two 499F strikes per 9954 and one per 9854 will be added. Each 499F strike is \$259.00 list.

ALUMINUM MULLIONS - FURNISHED WITH STABILIZERS AND WEATHERSTRIPPING

Description	For openings up to:	Specify		606, 612, 628, 710	711
		Model number	Finish		
Prepped for two 299 Strikes	7' 2"	5654	.[Finish]	\$1,999.00	\$2,400.00
	8' 2"			\$2,139.00	\$2,539.00
	10' 2"			\$2,539.00	\$3,005.00
Prepped for two 909 Strikes, for the XP device.	7' 2"	5654-XP	.[Finish]	\$1,999.00	\$2,400.00
	8' 2"			\$2,139.00	\$2,539.00
	10' 2"			\$2,539.00	\$3,005.00
Prepped for a 1408 Double Strike. Price includes strike. Note: If 5754 is ordered w/device - Specify device L/strike	7' 2"	5754	.[Finish]	\$2,397.00	\$2,801.00
	8' 2"			\$2,526.00	\$2,936.00
	10' 2"			\$2,801.00	\$2,943.00

Reference notes:

- Von Duprin Mullions are furnished for flat sills.
- Strikes are not included except where indicated.
- When required, strikes should be ordered with devices.
- Mullions are furnished standard for 7'0 doors when door height is not specified.
- Blank Mullions (without strike preparation) are available at the same price as standard Mullions.
- The 9854 and 9954 are U.L. Fire approved for heights up to 8'0" with 22-F and 88-F Rim Device. For door heights over 8'0" mullion is furnished less U.L. label.
- The 9854 and 9954 are U.L. Fire approved for heights up to 10'0" with 98/99-F Rim Device. For door heights over 10'0" mullion is furnished less U.L. label.
- ADA centerline height of 37" is available at no additional charge, must be specified.
- Special Centerlines (other than 39-11/16") or Special Length mullions, see page 18 for pricing.

MULLIONS

605	606	611	612	613	619	622	625	626	626AM	628	629
US3	US4	US9	US10	US10B	US15	US19	US26	US26D	US26DAM	US28	US32
630	630AM	643e	689	691	693	695	706	710	711	721	728
US32D	US32DAM	-	SP28	SP10	SPBLK	SP313	SP4	313	315	US3A	US4A

STEEL MULLION OPTIONS AND ACCESSORIES

Description	Specify (Prefix)	Price adjustment	
Keyed Removable option - KR1654/4954	KR	\$723.00	
Keyed Removable option - KR98/9954/4754/4854	KR	\$797.00	
Hurricane Wind-Only option - HW1654/4954/4954-XP	HW	\$75.00	
Hurricane Wind-Only option - HW9954/9954-XP	HW	\$150.00	
Description	Specify		Finish 689, 693, 695
	Model number	Finish	
Keyed Removable Kit for 1654 and 4954 Mullions	KR54	.[Finish]	\$723.00
Keyed Removable Kit for 98/9954/4754/4854 Mullion	KR54-F	.[Finish]	\$797.00
Wall Mounted Storage Kit "specify part number 050581"	MT54	.[Finish]	\$230.00
Mullion Stabilizers (set of four, 2 attach to the mullion and 2 to the door)	154	.[Finish]	\$140.00

ALUMINUM MULLION ACCESSORIES

Description	Specify (Prefix)	Price adjustment	
Hurricane Wind Only option - HW5654/5654-XP/5754	HW	\$75.00	
Description	Specify		Finish 689, 695
	Model number	Finish	
Mullion Angle Bracket - For Narrow Transom Bars	050092	.[Finish]	\$83.00

PARTS AND ACCESSORIES

MULLIONS

Description	Specify		Non-finished	622, 689, 693, 695	606, 612, 628, 710
	Part number	Finish			
5654/5754 Fitting Set	050130	.[Finish]	-	-	\$279.00
5654/5754 Top Fitting & Cover	050135	.[Finish]	-	-	\$170.00
KR54 Retrofit Kit	050168	.[Finish]	-	\$723.00	-
KR54-F Retrofit Kit	050169	.[Finish]	-	\$797.00	-
5654/5754 Bottom Fitting	050190	.[Finish]	-	-	\$168.00
9954 Fitting Set	050241	.[Finish]	-	\$527.00	-
1654/4954 Fitting Set	050330	.[Finish]	-	\$204.00	-
1654/4954 Top Fitting & Cover	050335	.[Finish]	-	\$99.00	-
4754/4854 Fitting Set	050371	.[Finish]	-	\$413.00	-
4754/4854 Top Electrical Fitting & Cover	050381	.[Finish]	-	\$315.00	-
9854 Top Mullion Fitting Kit	050383	.[Finish]	-	\$315.00	-
1654/4754/4854/4954 Bottom Fitting	050390	.[Finish]	-	\$97.00	-
9854/9954 Top Fitting & Cover	050391	.[Finish]	-	\$256.00	-
98/9954 Bottom Fitting	050392	.[Finish]	-	\$256.00	-
KR Mullion Cylinder Lock Nut	050526	-	\$20.00	-	-
Weatherstripping (10') Use 2 Per Mullion	050580	-	\$43.00	-	-
Mullion (Top) Screw Package	900400	-	\$27.00	-	-

ELECTRICAL / PARTS ACCESSORIES / PARTS GUARD-X SERIES 94/95 SERIES 98/99 SERIES 88 SERIES 55 SERIES 33A/35A SERIES 22 SERIES

PARTS AND ACCESSORIES

605	606	611	612	613	619	622	625	626	626AM	628	629
US3	US4	US9	US10	US10B	US15	US19	US26	US26D	US26DAM	US28	US32
630	630AM	643e	689	691	693	695	706	710	711	721	728
US32D	US32DAM	-	SP28	SP10	SPBLK	SP313	SP4	313	315	US3A	US4A

MULLIONS

Description	Specify		Non-finished	622, 689, 693, 695	606, 612, 628, 710
	Part number	Finish			
Mullion (Bottom) Screw Package	900402	-	\$37.00	-	-
KR1654/4954 Mullion Mounting Package	900409	.[Finish]	-	\$104.00	-
KR9854/9954 Mullion Mounting Package	900410	.[Finish]	-	\$87.00	-
9954 (Bottom) Screw Package	900411	-	\$35.00	-	-
9854/9954 (Top) Screw Package	900413	-	\$35.00	-	-
HH/HW9954/XP (Bottom) Screw Package	900431-00	-	\$180.00	-	-
HW1654/4954/XP/5654/5754/XP (Bottom) Screw Package	47415584	-	\$131.00	-	-
HH9954 Fitting Set	47506566	.[Finish]	-	\$554.00	\$554.00
HH9954 (Top) Fitting and Cover	47506568	.[Finish]	-	\$207.00	\$207.00
HH9954 (Bottom) Fitting	47506569	.[Finish]	-	\$350.00	\$350.00
4754/4854/4954 (Top) Fitting Cover	961047	.[Finish]	-	\$31.00	-
5654 Mullion Edging - 7'	965712	.[Finish]	-	-	\$95.00
5654 Mullion Edging - 8'	965713	.[Finish]	-	-	\$104.00
5654 Mullion Edging - 10'	965714	.[Finish]	-	-	\$117.00
9854/9954/HH9954 Top Fitting Cover	968645	.[Finish]	-	\$32.00	-
KR Inner Mullion Back Cover Plate	971187	.[Finish]	-	\$35.00	-
KR Shim Plate	971212	-	\$18.00	-	-
KR-F Shim Plate	971313	.[Finish]	-	\$61.00	-
KR9954 Top Fitting	971312	.[Finish]	-	\$172.00	-
KR9854/9954 Fusible Spacer	971316	.[Finish]	-	\$90.00	-
KR Mullion Cylinder Locking Washer	971328	-	\$26.00	-	-
KR1654/4954 Top Fitting	971340	.[Finish]	-	\$150.00	-
MT54 Wall Mounted Storage Kit	050581	.[Finish]	-	\$230.00	-
Female Receptacle Wire Assy	105987	-	\$128.00	-	-
Male Receptacle Wire Assy	105988	-	\$109.00	-	-
Mullion Stabilizers	050054	.[Finish]	-	\$140.00	-

ROD AND LATCH GUARDS

ROD AND LATCH GUARD - FOR USE WITH ALL VON DUPRIN SURFACE VERTICAL ROD DEVICES

Description	Specify			630
	Model number	Part number	Finish	
Rod and Latch Guard	RG-27	050061-32 (RHR), 050062-32 (LHR)	.[Finish]	\$668.00
Rod and Latch Guard Extended 3' Door	RG-27-3	050261-32 (RHR), 050262-32 (LHR)	.[Finish]	\$1,388.00
Rod And Latch Guard Extended 4' Door	RG-27-4	050263-32 (RHR), 050264-32 (LHR)	.[Finish]	\$1,796.00
Rod Guard Only	RGO	050066-32 (NON-HANDED)	.[Finish]	\$415.00
Latch Guard Only	LGO	050067-32 (RHR), 050068-32 (LHR)	.[Finish]	\$242.00
Latch Guard Only Extended 3' Door	LGO-3	050265-32 (RHR), 050266-32 (LHR)	.[Finish]	\$988.00
Latch Guard Only Extended 4' Door	LGO-4	050267-32 (RHR), 050268-32 (LHR)	.[Finish]	\$1,388.00
Latch Guard Only Extended, Windstorm, 3'	WS-LGO-3	117155-32 (RHR), 117157-32 (LHR)	.[Finish]	\$1,575.00
Latch Guard Only Extended, Windstorm, 4'	WS-LGO-4	117516-32 (RHR), 117158-32 (LHR)	.[Finish]	\$1,863.00

Note: Specify Handing.

RG-27 For bottom rod and latch protection. For top rod protection specify RGO as well.

MORTISE LOCKS

605	606	611	612	613	619	622	625	626	626AM	628	629
US3	US4	US9	US10	US10B	US15	US19	US26	US26D	US26DAM	US28	US32
630	630AM	643e	689	691	693	695	706	710	711	721	728
US32D	US32DAM	-	SP28	SP10	SPBLK	SP313	SP4	313	315	US3A	US4A

MORTISE LOCKS FOR PANIC AND FIRE-RATED MORTISE LOCK DEVICES

Description	Specify		630	605, 606, 612, 613, 622, 629, 693
	Model number	Finish		
Standard Mortise Lock	7500	.[Finish]	\$945.00	\$977.00
Double Cylinder Mortise Lock	7500-2	.[Finish]	\$1,236.00	\$1,268.00
INPACT Device Mortise Lock	7500-IN	.[Finish]	\$1,176.00	\$1,207.00
Electric Unlocking Mortise Lock	E7500	.[Finish]	\$1,854.00	\$1,886.00
Signal Switch Mortise Lock	SS7500	.[Finish]	\$1,310.00	\$1,342.00
94/9575 Signal Switch Mortise Lock	SS7500-IN	.[Finish]	\$1,541.00	\$1,572.00

PARTS AND ACCESSORIES

7500 SERIES MORTISE LOCK

Description	Specify		Non-finished	630	606 613 622	612	605	629
	Part number	Finish						
E7500 Solenoid Replacement Kit 12VDC FSE*	050212	-	\$358.00	-	-	-	-	-
E7500 Solenoid Replacement Kit 12VDC FS*	050213	-	\$358.00	-	-	-	-	-
E7500 Solenoid Replacement Kit 24VDC FSE*	050214	-	\$358.00	-	-	-	-	-
E7500 Solenoid Replacement Kit 24VDC FS*	050215	-	\$358.00	-	-	-	-	-
E/SS7500 Female Terminal	050540	-	\$20.00	-	-	-	-	-
7500 Auxiliary Bolt Link Sub-Assembly	109347	-	\$56.00	-	-	-	-	-
E7500 Hook-up Wire Assy	114140	-	\$95.00	-	-	-	-	-
SS7500 Wire Harness Switch Sub-Assembly	114294	-	\$152.00	-	-	-	-	-
7500 Latch Bolt and Faceplate Sub-Assembly	109773	-	\$101.00	-	-	-	-	-
E7500 Switch Connector Assembly	110744	-	\$191.00	-	-	-	-	-
7500-2 Cylinder Plug Assembly	111943	-	\$270.00	-	-	-	-	-
E7500 Plunger Sub-Assembly FSE	47381131	-	\$21.00	-	-	-	-	-
E7500 Plunger Sub-Assembly FS	47381132	-	\$21.00	-	-	-	-	-
7500 Lock Mounting Pkg	900532	.[Finish]	-	\$19.00	\$19.00	\$19.00	\$19.00	-
7500 Scalp Plate - 8-32 x 3/8" FPHMS	963080	.[Finish]	-	\$19.00	\$19.00	\$19.00	\$19.00	-
7500 Hsg. Cover - 8-32 x 3/8" UFPHMS	964330	-	\$19.00	-	-	-	-	-
7500 Housing 8-32 x 3/8" PPH TF	964390	-	\$16.00	-	-	-	-	-
7500 Cyl. Set - 8-32 x 2" Fill SHMS	963954	-	\$19.00	-	-	-	-	-
#8 SAE Flat Washer	963984	-	\$19.00	-	-	-	-	-
E7500 FSE Roll Pin - 3/32 x 9/16"	964035	-	\$19.00	-	-	-	-	-
7500 Auxiliary Bolt	968668	-	\$76.00	-	-	-	-	-
7500 Deadlocking Spring	968748	-	\$19.00	-	-	-	-	-
7500 Trim Bolt Retractor	968761	-	\$19.00	-	-	-	-	-
7500 Thumb Latch Lift	968763	-	\$19.00	-	-	-	-	-
7500 Knob Cam	968765	-	\$57.00	-	-	-	-	-
7500 Scalp Plate	968766	.[Finish]	-	\$184.00	-	-	-	\$277.00
7500 Scalp Plate	970872	.[Finish]	-	-	\$188.00	\$188.00	\$277.00	-

*For Mortise Lock shipped after 1992. For Mortise Locks shipped before 1992, entire Lock must be replaced

PARTS AND ACCESSORIES

605	606	611	612	613	619	622	625	626	626AM	628	629
US3	US4	US9	US10	US10B	US15	US19	US26	US26D	US26DAM	US28	US32
630	630AM	643e	689	691	693	695	706	710	711	721	728
US32D	US32DAM	-	SP28	SP10	SPBLK	SP313	SP4	313	315	US3A	US4A

7500 SERIES MORTISE LOCK

Description	Specify		Non-finished	630	606 613 622	612	605	629
	Part number	Finish						
E/SS7500 Switch Insulator	968770	-	\$20.00	-	-	-	-	-
7500 Deadlock Release Arm	968773	-	\$42.00	-	-	-	-	-
7500 Auxiliary Bolt Spring	968935	-	\$19.00	-	-	-	-	-
7500 Latch Bolt Collar	968939	-	\$41.00	-	-	-	-	-
7500 Latch Return Spring	969089	-	\$19.00	-	-	-	-	-
E7500 FSE Torsion Spring	969107	-	\$20.00	-	-	-	-	-
7500 Trim Lock Slide Spring	969364	-	\$19.00	-	-	-	-	-
7500 Latch Return Spring Guide	969610	-	\$19.00	-	-	-	-	-
7500 Trim Lock Spring Guide	970188	-	\$19.00	-	-	-	-	-
7500 Crossbar Input Arm	970318	-	\$41.00	-	-	-	-	-
E7500 FS Trim Lock Slide Spring	970546	-	\$20.00	-	-	-	-	-
7500 Stem Support	970735	-	\$19.00	-	-	-	-	-
E7500 Lever Screw	970861	-	\$24.00	-	-	-	-	-
E7500 Lever Spacer	970862	-	\$20.00	-	-	-	-	-
E7500 FS Trim Lock Lever	972549	-	\$21.00	-	-	-	-	-
E7500 Solenoid Spring	971320	-	\$19.00	-	-	-	-	-
7500 Housing Cover	971822	-	\$73.00	-	-	-	-	-
7500 Trim Lock Actuator	968793	-	\$19.00	-	-	-	-	-
7500-2 Trim Lock Actuator	970531	-	\$44.00	-	-	-	-	-
7500-IN Rod Connector	971832	-	\$109.00	-	-	-	-	-
6000 Strike/E/SS7500 Switch CON Adapter Harness	106181	-	\$45.00	-	-	-	-	-

*For Mortise Lock shipped after 1992. For Mortise Locks shipped before 1992, entire Lock must be replaced

237 TWO POINT LATCH

237 TWO POINT LATCH

Function	Push	Pull	Specify		613 626	612	606	605 625
			Model number	Finish				
OUTSWING DOOR (RHR AND LHR)								
Exit Only	237 BE	None	237EO	.[Finish]	\$3,943.00	\$3,943.00	\$3,786.00	\$4,031.00
Class room	237 BE	378 w/cyl	237L	.[Finish]	\$4,987.00	\$5,048.00	\$4,688.00	\$5,169.00
Passage	237 BE	378 BE	237L-BE	.[Finish]	\$4,938.00	\$5,004.00	\$4,625.00	\$5,110.00
Storeroom	237 BE	378 NL	237L-NL	.[Finish]	\$4,987.00	\$5,048.00	\$4,688.00	\$5,169.00
INSWING DOOR (RH AND LH)								
Exit Only	None	237 BE	237EO	.[Finish]	\$3,943.00	\$3,943.00	\$3,786.00	\$4,031.00
Class room	378 w/cyl	237 BE	237L	.[Finish]	\$4,987.00	\$5,048.00	\$4,688.00	\$5,169.00
Passage	378 BE	237 BE	237L-BE	.[Finish]	\$4,938.00	\$5,004.00	\$4,625.00	\$5,110.00
Storeroom	378 NL	237 BE	237L-NL	.[Finish]	\$4,987.00	\$5,048.00	\$4,688.00	\$5,169.00

NOTES:

- Price includes 304L Strike. Cylinders are not included.
- Can not be used on doors requiring panic or fire exit hardware.
- Windstorm-rated 237 outswing only
- If cylinder is required on push side, add suffix "C" to model #. (e.g. 237EO-C)
- Cylinder (mortise 3215) not included in pricing.
- The #06 Lever is furnished standard.
- Optional lever designs, #03 and #17 are available at no additional charge

237 TWO POINT LATCH

605	606	611	612	613	619	622	625	626	626AM	628	629
US3	US4	US9	US10	US10B	US15	US19	US26	US26D	US26DAM	US28	US32
630	630AM	643e	689	691	693	695	706	710	711	721	728
US32D	US32DAM	-	SP28	SP10	SPBLK	SP313	SP4	313	315	US3A	US4A

- UL Listing: Two-and Three-point Locks and Latches (for Fire Doors) – UL 10 C.
- Rating: 3HR Pairs (Double Egress), 90 Min. Pairs (Swing Same Direction), Door Size: 8'0 x 8'0 Pairs (Hollow Metal only)
- Windstorm Rating: UL-FEMA 320 and 361 certified: 4'0 x 8'0 Single Doors (Non-fire-rated) Hollow Metal,
- 8'0 x 8'0 Pairs Hollow Metal. UL –ANSI/ICC 500 certified for F5 Tornado applications.
- These products are listed with Steelcraft PW14 Series door for Tornado Listings.

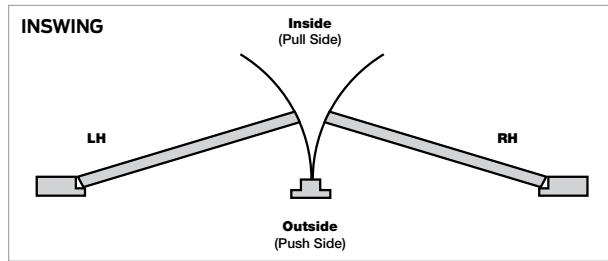
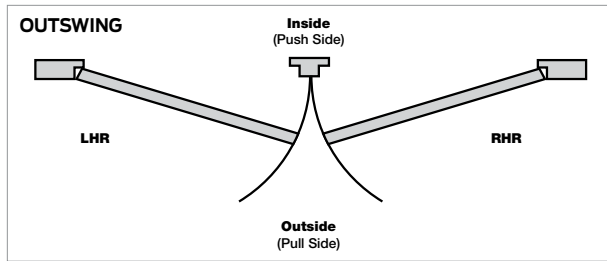

NOMENCLATURE – HOW TO ORDER

Model	Handing	Lever style	Finish
1	2	3	4
237EO -	RHR -	06 -	626

1 Model	
EO	Exit Only EO
L	Lever (classroom)
L-BE	Lever - blank escutcheon
L-NL	Lever, rigid - night latch

2 Handing	
LH	Left hand
RH	Right hand

2 Handing	
LHR	Left hand reverse
RHR	Right hand reverse

3 Lever style	
06	Standard default
03	
17	

4 Finish	
605	Bright Brass
606	Satin Brass
612	Satin Bronze
613	Oil Rubbed Bronze
625	Bright Chrome
626	Satin Chrome

PARTS AND ACCESSORIES

237 TWO POINT LATCH								
Description	Specify		Non-finished	630	613	612	606	629
	Part number	Finish						
237 Top Rod Assembly	112845	.[Finish]	-	\$672.00	\$684.00	\$619.00	\$775.00	\$748.00
237 Bottom Rod Assembly	112844	-	\$202.00	-	-	-	-	-
237 Mounting Plate Package	112835	.[Finish]	-	\$17.00	\$22.00	\$22.00	\$55.00	\$17.00

22 SERIES
 33A/35A SERIES
 55 SERIES
 88 SERIES
 98/99 SERIES
 XP98/XP99 SERIES
 94/95 SERIES
 GUARD-X SERIES
 ACCESSORIES / PARTS
 ELECTRICAL / PARTS

EXTENSION ROD KITS

605	606	611	612	613	619	622	625	626	626AM	628	629
US3	US4	US9	US10	US10B	US15	US19	US26	US26D	US26DAM	US28	US32
630	630AM	643e	689	691	693	695	706	710	711	721	728
US32D	US32DAM	-	SP28	SP10	SPBLK	SP313	SP4	313	315	US3A	US4A

EXTENSION ROD KITS - ALL FINISHES	Specify	Price adjustment
12" Extension Rod for 8827	ER-12-88	\$42.00
24" Extension Rod for 8827	ER-24-88	\$42.00
36" Extension Rod for 2227, 3327A, 3527A, 9827, 9857, 9927, 9957	ER-36-22/33A/99	\$42.00
12" Extension Rod for WS98/9927	ER-12-WS	\$42.00
Adjustable Extension Rod, over 8' up to 10' for 5547, 5547WDC, 8847	ER-ADJ10-55/88	\$42.00
Adjustable Extension Rod, 8'4" - 10' for 3347A, 3348A, 3547A, 3548A, 9847, 9847WDC, 9848, 9947, 9947WDC, 9948	ER-ADJ10-33A/99	\$42.00
Adjustable Extension Rod, over 8' up to 9'8" for 9447, 9547	ER-ADJ9.8-94	\$42.00

EXTENSION ROD KITS (FOR NON-STANDARD DOOR HEIGHTS)										
Description	Specify		Non-finished	619	710	612	606	605	711	643e
	Model number	Finish		626	613		625	629		693
36" Extension Rod for 8827	ER-36-88	.[Finish]	—	\$128.00	\$196.00	\$142.00	\$124.00	\$438.00	—	\$438.00
48" Extension Rod for 8827	ER-48-88	.[Finish]	—	\$149.00	\$216.00	\$173.00	\$142.00	\$459.00	—	\$459.00
60" Extension Rod for 3327A, 3527A	ER-60-33A	.[Finish]	—	\$449.00	\$369.00	\$431.00	\$420.00	\$449.00	\$449.00	—
60" Extension Rod for 9827, 9857, 9927, 9957	ER-60-99	.[Finish]	—	\$199.00	\$199.00	\$369.00	\$242.00	\$390.00	\$390.00	—
Adjustable Extension Rod, 10' - 11'8" for 3347A, 3547A, 9847, 9847WDC, 9848, 9947, 9947WDC, 9948	ER-ADJ11.8-33A/99	-	\$137.00	—	—	—	—	—	—	—
Adjustable Extension Rod 11'8" - 13'4" for 3347A, 3547A, 9847, 9847WDC, 9848, 9947, 9947WDC, 9948	ER-ADJ13.4-33A/99	-	\$153.00	—	—	—	—	—	—	—
Adjustable Extension Rod, 13'4" - 15' for 3347A, 3547A, 9847, 9847WDC, 9848, 9947, 9947WDC, 9948	ER-ADJ15-33A/99	-	\$153.00	—	—	—	—	—	—	—
Adjustable Extension Rod 10' - 12' for 5547	ER-ADJ12-5547	-	\$136.00	—	—	—	—	—	—	—
Adjustable Extension Rod 12' - 14' for 5547	ER-ADJ14-5547	-	\$136.00	—	—	—	—	—	—	—
Adjustable Extension Rod, 14' - 16' for 5547	ER-ADJ16-5547	-	\$136.00	—	—	—	—	—	—	—
Adjustable Extension Rod 10' - 12' for 5547WDC	ER-ADJ12-5547WDC	-	\$300.00	—	—	—	—	—	—	—
Adjustable Extension Rod 12' - 14' for 5547WDC	ER-ADJ14-5547WDC	-	\$300.00	—	—	—	—	—	—	—
Adjustable Extension Rod, 14' - 16' for 5547WDC	ER-ADJ16-5547WDC	-	\$300.00	—	—	—	—	—	—	—
Adjustable Extension Rod 10' - 12' for 5547-F, 8847-F	ER-ADJ12-5547F	-	\$286.00	—	—	—	—	—	—	—
Adjustable Extension Rod 12' - 14' for 5547-F, 8847-F	ER-ADJ14-5547F	-	\$286.00	—	—	—	—	—	—	—
Adjustable Extension Rod, 14' - 16' for 5547-F, 8847-F	ER-ADJ16-5547	-	\$286.00	—	—	—	—	—	—	—

NOTE: Fire rated devices over 8' may be provided less UL label based on the door application.
CAUTION: Other special door and frame conditions may require additional charges. Consult factory

ONE PIECE TOP ROD KITS										
Description	Specify		626	710	612	606	605, 619, 625, 630	711	693	
	Model number	Finish								
8 - for door heights up to 8' for 8827	OP-8-88	.[Finish]	\$192.00	\$275.00	\$297.00	\$239.00	\$593.00	—	\$593.00	
8 - for door heights up to 8' for 9827, 9857, 9927, 9957	OP-8-99	.[Finish]	\$333.00	\$333.00	\$211.00	\$168.00	\$333.00	\$333.00	—	
10' - for door heights up to 10' for 9827, 9857, 9927, 9957	OP-10-99	.[Finish]	\$367.00	\$367.00	\$233.00	\$203.00	\$360.00	\$360.00	—	
12 - for door heights up to 12' for 9827, 9857, 9927, 9957	OP-12-99	.[Finish]	\$390.00	\$390.00	\$257.00	\$239.00	\$405.00	\$405.00	—	

NOTE: Fire rated devices over 8' may be provided less UL label based on the door application.
CAUTION: Other special door and frame conditions may require additional charges. Consult factory

SECURITY SCREW PACKAGES

605	606	611	612	613	619	622	625	626	626AM	628	629
US3	US4	US9	US10	US10B	US15	US19	US26	US26D	US26DAM	US28	US32
630	630AM	643e	689	691	693	695	706	710	711	721	728
US32D	US32DAM	-	SP28	SP10	SPBLK	SP313	SP4	313	315	US3A	US4A

Security Screws are pin-in-socket type and require special hex wrenches

DEVICES	Wrench Model# Required	Price adjustment (all finishes)
22/22-F Rim	2	\$24.00
2227/2227-F	2	\$76.00
33A/35A Rim	2	\$40.00
33A/3527A	2	\$101.00
33/3547A/47A-F	2	\$56.00
88/88-F Rim/8875/75-F	2	\$62.00
8827	2	\$98.00
8827-F	2	\$146.00
8847-F	2	\$78.00
98/99/99-F/98-F Rim/98/9975/75-F	2	\$78.00
98/9927/27-F	2	\$93.00
98/9947/47-F and WDC	2	\$75.00

TRIMS AND CONTROLS	Wrench Model# Required	Price adjustment (all finishes)
230/880/990	2	\$20.00
386/360L-DTx330/350	2	\$31.00
371/373	2	\$43.00
374/376/377	2	\$20.00
696/697	2	\$19.00

MECHANICAL STRIKES	Wrench Model# Required	Price adjustment (all finishes)
1439/1606/248L-4/264/266/299/299F	2	\$20.00
1408	2	\$36.00
268	2	\$32.00
338	2	\$18.00
385A	2	\$16.00
499F	2	\$57.00
575/576	2	\$19.00

OTHER MECHANICAL PRODUCTS	Wrench Model# Required	Price adjustment (all finishes)
330/350 Pushbar	2	\$40.00
1654/4954 Mullion	2	\$55.00
5654/5754 Mullion	2	\$30.00
9954 Mullion	2, 4	\$127.00
154 Mullion Stabilizer	2	\$44.00
7500 Lock	2	\$19.00

SECURITY SCREW PACKAGES

605	606	611	612	613	619	622	625	626	626AM	628	629
US3	US4	US9	US10	US10B	US15	US19	US26	US26D	US26DAM	US28	US32
630	630AM	643e	689	691	693	695	706	710	711	721	728
US32D	US32DAM	-	SP28	SP10	SPBLK	SP313	SP4	313	315	US3A	US4A

Security Screws are pin-in-socket type and require special hex wrenches

ELECTRICAL PRODUCTS	Wrench Model# Required	Price adjustment (all finishes)
4263/4570/4582/4690 Monitor Strike	2	\$19.00
4670 Monitor Strike	2	\$19.00
6211-16/6222-26 Electric Strike	2	\$18.00
EPT	2	\$93.00

WRENCHES (ONE SET CHARGED PER ORDER UNLESS SPECIFIED OTHERWISE)	Model number	Specify	Price adjustment
1/8" Hex - #6 Screw	#1	010060-00	\$30.00
5/32" Hex - #8-1/4 Screw	#2	010059-00	\$30.00
7/32" Hex - 3/8 Screw	#3	010061-00	\$30.00
3/16" Hex - 5/16 Screw	#4	010062-00	\$30.00

SEX BOLTS

SEX BOLTS - MACHINE SCREWS ARE SUPPLIED WITH THE DEVICE	Specify	Price adjustment
Thread Size 10-24, Package of 2	425	\$38.00
Thread Size 12-24, Package of 2	625	\$38.00
Thread Size 1/4-20, Package of 2	325	\$38.00
Thread Size 12-24, Package of 2	525	\$38.00
Thread Size 10-24, Package of 2	825	\$38.00

REFERENCE NOTE: 625 and 825 sexbolts furnished standard for 1-3/4" thick door. Specify 2-1/4" if required.

SLM BLOCKING MOUNTING PACKAGES

SLM BLOCKING MOUNTING PACKAGES			
Description	Specify	Non-finished	605, 606, 613, 629, 630
	Finish		
98/99 Rim	.[Finish]	\$32.00	—
9827/9927	.[Finish]	\$43.00	—
9875/9975/9847WDC/9947WDC/9850WDC/9950WDC	.[Finish]	\$19.00	—
88 Rim	.[Finish]	—	\$47.00
8827	.[Finish]	—	\$86.00
8875	.[Finish]	—	\$47.00
5547WDC	.[Finish]	—	\$57.00
RG-27	.[Finish]	\$43.00	—
RGO	.[Finish]	\$19.00	—
LGO	.[Finish]	\$19.00	—

REFERENCE NOTES: For use with devices on doors with special high density blocking material. Blocking material must be UL or Warnock Hersey approved.

PARTS AND ACCESSORIES

605	606	611	612	613	619	622	625	626	626AM	628	629
US3	US4	US9	US10	US10B	US15	US19	US26	US26D	US26DAM	US28	US32
630	630AM	643e	689	691	693	695	706	710	711	721	728
US32D	US32DAM	-	SP28	SP10	SPBLK	SP313	SP4	313	315	US3A	US4A

SCREW PACKS/SHIMS/MISCELLANEOUS

SHIMS

Description	Specify		Non-finished	619, 689, 691, 695, 706
	Part number	Finish		
Shim 1409 Strike	959953	-	\$24.00	-
Shim 1606 Strike	961084	-	\$31.00	-
Shim 248L-4 Strike	969280	-	\$19.00	-
Shim 264/299F/499F Strike	945521	-	\$19.00	-
Shim 266 Strike	967333	.[Finish]	-	\$70.00
Shim 299 Strike	970321	-	\$19.00	-
Shim 268 Strike Auxiliary Bolt	967269	-	\$19.00	-
909 Strike Shim Pkg/4	090108	-	\$94.00	-
Mullion Stabilizer Shim	961530	-	\$18.00	-
99 Hinge Stile Shim	971010	.[Finish]	-	\$70.00
150 Strike Shim Pkg/10	47396155	-	\$25.00	-
249 Strike Shim Pkg/10	47396154	-	\$36.00	-

SCREW PACKS

Description	Specify		Non-finished	630	612	605, 606, 613	619, 689, 691, 695, 706
	Part number	Finish					
Screw Package 268/472/473	900252	-	\$19.00	-	-	-	-
Screw Package 1408	900253	-	\$19.00	-	-	-	-
Screw Package 1409/1410/1439	900254	-	\$24.00	-	-	-	-
Screw Package 248L-4/264/266/1606	900263	-	\$19.00	\$19.00	-	\$19.00	-
Screw Package 4263/4582	900281	.[Finish]	-	\$21.00	-	\$21.00	-
Screw Package 4268	900284	.[Finish]	-	\$20.00	\$31.00	\$20.00	-
Screw Package 338	900285	-	\$19.00	-	-	-	-
Screw Package 499-F	900289	-	\$24.00	-	-	-	-
Screw Package 575/575-2/576/4690	900532	.[Finish]	-	\$19.00	\$19.00	\$19.00	-
Screw Package 889 Cover Plate	900820	.[Finish]	-	\$24.00	\$24.00	\$24.00	-
Screw Package 99GBK-R x 499F 1-3/4" Dr	900847	.[Finish]	-	\$31.00	\$31.00	\$31.00	-
Screw Package 99GBK-R x 499F 2-1/4" Dr	900848	.[Finish]	-	\$31.00	\$31.00	\$31.00	-
Screw Package 99GBK-R/M/V	900849	-	\$30.00	-	-	-	-
Screw Package RG27	900888	-	\$20.00	-	-	-	-

MISCELLANEOUS

Description	Specify		Non-finished	630	612	605, 606, 613, 629	619, 689, 691, 695, 706
	Part number	Finish					
DL Lubricant 1 oz.	091091	-	\$18.00	-	-	-	-
Monitor Strike Spacer Plate - 4263/4268	966671	-	\$24.00	-	-	-	-
Strike Hook 499-F	661481	.[Finish]	-	\$179.00	\$179.00	\$179.00	-
Strike Plate 299	970323	-	\$19.00	-	-	-	-

PARTS AND ACCESSORIES

605	606	611	612	613	619	622	625	626	626AM	628	629
US3	US4	US9	US10	US10B	US15	US19	US26	US26D	US26DAM	US28	US32
630	630AM	643e	689	691	693	695	706	710	711	721	728
US32D	US32DAM	-	SP28	SP10	SPBLK	SP313	SP4	313	315	US3A	US4A

MISCELLANEOUS							
Description	Specify		Non-finished	630	612	605, 606, 613, 629	619, 689, 691, 695, 706
	Part number	Finish					
Strike Pop Rivet 1409/1439	963074	-	\$19.00	-	-	-	-
1409 Adjusting Block	959952	-	\$24.00	-	-	-	-
1409/1410 Wear Strip	960012	-	\$36.00	-	-	-	-
Latch Guard Mounting Bracket	970472	-	\$24.00	-	-	-	-
Security Screw Hex Key 5/32"	010059	-	\$30.00	-	-	-	-
Security Screw Hex Key 1/8"	010060	-	\$30.00	-	-	-	-
Security Screw Hex Key 7/32"	010061	-	\$30.00	-	-	-	-
Security Screw Hex Key 3/16"	010062	-	\$30.00	-	-	-	-
299F Strike Adapter	050996	.[Finish]	-	-	-	-	\$233.00
WDC Strike Filler Plate kit	47244841	-	\$19.00	-	-	-	-

MAINTENANCE KIT AND REPLACEMENT PACKAGES

MAINTENANCE KIT AND REPLACEMENT PACKAGES		
Description	Part number	List price
98/99 Maintenance Kit	050046	\$1,683.00
Control Link Pin Pkg/10	090031	\$24.00
33/35/98/99 Touch Bar Guide Pkg/10	090049	\$20.00
NL Drive Screw Pkg/10	090074	\$30.00
98/9927/27-F Auxiliary Bolt Spring Pkg/ 10	090076	\$19.00
Bolt Return Spring Pkg/10	090065	\$19.00
#10 External Tooth Lock Washer Pkg/10	PKGSRV.1007	\$19.00
Top Latch Compression Spring Pkg/10	090056	\$19.00
Truarc Retaining Ring T5304-18 Pkg/10	090107	\$19.00
Shear Pin - 360/992/994/996 Pkg/50	PKGSRV.1010	\$90.00
992L Lift Spring Pkg/20	PKGSRV.1011	\$33.00
1/4-20 Hex Stud - 991/992 Pkg/10	PKGSRV.1012	\$43.00
Truarc Retaining Ring 5160-42 Pkg/10	PKGSRV.1013	\$30.00
10-32 X 1/4" UFPHMS w/Nylock Pkg/6	090059	\$19.00
10-24 x 3/4" PPHMS Pkg/10	PKGSRV.1015	\$19.00
10-24 x 1" PPHMS Pkg/20	PKGSRV.1016	\$24.00
8-32 X 1/4" UFPHMS Pkg/20	PKGSRV.1018	\$19.00
LBR Latch Mtg Screw Pkg/10	PKGSRV.1019	\$20.00
1/4-20 X 3/4" UFPHMS Pkg/10	PKGSRV.1020	\$31.00
10-24 X 13/8" PPHMS Pkg/20	PKGSRV.1022	\$31.00
10-24 X 3/4" FPHMS Pkg/10	PKGSRV.1023	\$19.00
12-24-1/2" Hex Wshr Hd Tapping Screw Pkg/10	090073	\$17.00

PARTS AND ACCESSORIES

605	606	611	612	613	619	622	625	626	626AM	628	629
US3	US4	US9	US10	US10B	US15	US19	US26	US26D	US26DAM	US28	US32
630	630AM	643e	689	691	693	695	706	710	711	721	728
US32D	US32DAM	-	SP28	SP10	SPBLK	SP313	SP4	313	315	US3A	US4A

SERVICE REPLACEMENT PARTS

SERVICE REPLACEMENT									
Description	Specify		Non-finished	613 626	612	606	605 625	629 693 695	622 630
	Part number	Finish							
7500-880TP Retrofit Kit	050122	.[Finish]	-	\$98.00	-	\$98.00	\$98.00	-	-
End Cap Mtg. Brkt. Screw (Pkg of 30)	090060	-	\$76.00	-	-	-	-	-	-
Old Style Hex Dogging Retrofit Kit	050709	-	\$98.00	-	-	-	-	-	-
Old Style 227 Dog Key 5/32" (Pkg of 10)	090084	-	\$101.00	-	-	-	-	-	-
34/58 Thumb Latch Lift Spring (Pkg of 5)	091030	-	\$98.00	-	-	-	-	-	-
34/58 Dog Lock Spring (Pkg of 10)	091031	-	\$179.00	-	-	-	-	-	-
34/58 Auxiliary Bolt Spring (Pkg of 10)	091032	-	\$293.00	-	-	-	-	-	-
66 Dog Screw (Pkg of 10)	091061	-	\$208.00	-	-	-	-	-	-
222 Dog Key 7/32" (Pkg of 10)	091080	-	\$138.00	-	-	-	-	-	-
Wedgetite Screw - Fine Thread (Pkg of 10)	091082	-	\$94.00	-	-	-	-	-	-
370 Series 6-32 x 1/4 UFPHMS	963150	-	\$19.00	-	-	-	-	-	-
370 Series 1/4-20 x 1 Set Screw	963584	-	\$19.00	-	-	-	-	-	-
33/3527 Bottom Rod Roll Pin	963585	-	\$19.00	-	-	-	-	-	-
SS333NL Backplate Screw 8-32 x 3/8" PPHMS	963712	-	\$19.00	-	-	-	-	-	-
10-24 x 1/2" UFPHMS Epoxy Lock	963873	-	\$19.00	-	-	-	-	-	-
370 Series 6-32 x 7/16" PPHMS	963902	-	\$19.00	-	-	-	-	-	-
333/337 1/4-20 x 2 Socket Set Screw	963905	-	\$19.00	-	-	-	-	-	-
370 Series #10 Flat Washer	964375	-	\$19.00	-	-	-	-	-	-
334/333/337/3308 Sex Bolt Extension	971614	-	\$20.00	-	-	-	-	-	-
SD WDC FINGER KIT	47244842	-	\$127.00						

Z2 SERIES
 33A/35A SERIES
 55 SERIES
 88 SERIES
 98/99 SERIES
 XP98/XP99 SERIES
 94/95 SERIES
 GUARD-X SERIES
 ACCESSORIES / PARTS
 ELECTRICAL / PARTS

PARTS AND ACCESSORIES

605	606	611	612	613	619	622	625	626	626AM	628	629
US3	US4	US9	US10	US10B	US15	US19	US26	US26D	US26DAM	US28	US32
630	630AM	643e	689	691	693	695	706	710	711	721	728
US32D	US32DAM	-	SP28	SP10	SPBLK	SP313	SP4	313	315	US3A	US4A

SERVICE REPLACEMENT										
Description	Specify		Non-finished	613 626	612	606	605 625	629 693 695	622 630	
	Part number	Finish								
NOTE ORIGINAL SHIP DATE ON PARTS LISTED BELOW										
For EL Devices shipped before January 1987										
EL Solenoid Replacement Kit	050218	-	\$1,038.00	-	-	-	-	-	-	-
For Trims shipped before October 1989										
Orbit Knob Assy - 606K/880K Trim	108490	.[Finish]	-	\$300.00	-	\$300.00	\$300.00	-	-	-
Orbit Knob Assy - 606K-DT/880K-DT Trim	108493	.[Finish]	-	\$300.00	-	\$300.00	\$300.00	-	-	-
880 Knob Booster Spring Assembly	033024	-	\$73.00	-	-	-	-	-	-	-
For Devices shipped before July 1997										
#22 Hitch Pin - Hex/CD Dogging old style	963909	-	\$19.00	-	-	-	-	-	-	-
Dogging Shaft - Hex Dogging Old Style	968112	-	\$24.00	-	-	-	-	-	-	-
CD Actuator Arm - Cylinder Dogg Old Style	968116	-	\$20.00	-	-	-	-	-	-	-
For Devices shipped before August 1997										
7500-373L Retrofit Kit	050124	-	\$31.00	-	-	-	-	-	-	-
For Devices shipped before October 1998										
22/98/9927/-F Btm Latch/Brkt Repl. Kit	050090	.[Finish]	-	-	\$208.00	\$208.00	\$208.00	\$208.00	\$229.00	
22/98/9927/-F Top Latch/Brkt Repl. Kit	050091	.[Finish]	-	-	\$208.00	\$208.00	\$208.00	\$208.00	\$208.00	
22/98/9927/27-F Latch Mtg. Screws 1-3/4" Dr	900564	-	\$19.00	-	-	-	-	-	-	
22/98/9927/27-F Latch Mtg. Screws 2-1/4" Dr	900569	-	\$19.00	-	-	-	-	-	-	
For Devices shipped before January 2002										
Mechanism End Cap Screw Package	900901	.[Finish]	-	\$19.00	\$24.00	\$19.00	-	-	\$19.00	
RX 330/350 Old Style End Cap Mtg. Bracket for Lock Stile	050397	-	\$20.00	-	-	-	-	-	-	
For Devices shipped before April 2003										
47 Btm Latch Spirol Pin (Pkg of 10)	090062	-	\$24.00	-	-	-	-	-	-	
For Controls shipped before January 2008										
376WDC Rod member Kit 1-3/4"	109113	-	\$188.00	-	-	-	-	-	-	
376WDC Rod Member Kit 2" Door	900583	.[Finish]	-	\$203.00	\$203.00	\$203.00	\$203.00	\$203.00	\$203.00	
376WDC Rod Member Kit 2-1/4" Door	109118	-	\$267.00	-	-	-	-	-	-	

III
22 SERIES
33A/35A SERIES
55 SERIES
88 SERIES
98/99 SERIES
XP98/XP99 SERIES
94/95 SERIES
GUARD-X SERIES
ACCESSORIES / PARTS
ELECTRICAL / PARTS

ELECTRICAL PRODUCTS AND PARTS

EXIT ALARM KITS

605	606	611	612	613	619	622	625	626	626AM	628	629
US3	US4	US9	US10	US10B	US15	US19	US26	US26D	US26DAM	US28	US32
630	630AM	643e	689	691	693	695	706	710	711	721	728
US32D	US32DAM	-	SP28	SP10	SPBLK	SP313	SP4	313	315	US3A	US4A

EXIT ALARM KITS									
Description	Specify		619	689 695	606, 612, 628, 710	630	605, 625, 711	526	622
	Model number	Finish							
Alarm Kit for 22 Series devices	22 ALK	.[Finish]	—	\$805.00	—	—	—	\$885.00	\$848.00
Alarm Kit for 33A Series devices	33A-ALK	.[Finish]	—	—	\$907.00	—	\$907.00	—	—
Alarm Kit for 35A Series devices	35A-ALK	.[Finish]	\$907.00	—	\$907.00	—	\$907.00	—	—
Alarm Kit for 98 Series devices	98 ALK	.[Finish]	\$907.00	—	\$907.00	\$907.00	\$907.00	—	—
Alarm Kit for 99 Series devices	99 ALK	.[Finish]	—	—	\$907.00	—	\$907.00	—	—

REFERENCE NOTES:

RX is standard, LX is optional at no charge.

When ordering alarm kits separate from devices, the 3' device kit is furnished standard. Specify 4' if required, no additional charge.

The "EI" External Inhibit feature is standard on the ALK at no additional charge.

OPTIONS

CONNECTORS	Specify	Price adjustment
Cross-category solution using interconnect components for electrified options. Available with ALK at no additional charge.	CON	\$0.00

SWITCHES - Above prices include switch kit - "RX" is standard, "LX" is optional at no charge.	Specify	Price adjustment
Less Switch	Less Switch	-\$365.00

PARTS AND ACCESSORIES

ALARM KIT						
For compatibility purposes on ALK product produced prior to July 2021, it is recommended to replace with a new ALK kit.						
Description	Specify		Non-finished	689, 695	606, 626, 695	612, 619, 625, 622, 605
	Part number	Finish				
ALK Cylinder Collar - 22	967704	.[Finish]	—	\$33.00	—	—
ALK Cylinder Collar - 33A/35A/98/99	050525	.[Finish]	—	\$62.00	\$62.00	\$78.00
ALK Sign	SIGN-1	-	\$36.00	—	—	—
ALK Arming Label	969349	-	\$20.00	—	—	—
ALK Disarming Label	969350	-	\$20.00	—	—	—
ALK Retainer Nut	969354	-	\$34.00	—	—	—
ALK Battery	990637	-	\$35.00	—	—	—
ALK CON Adapter Harness	106182	-	\$20.00	—	—	—
Cover Plate Anti-Rattle Spring Pkg/10	090036	-	\$19.00	—	—	—
Nylon Snap Rivet Pkg/10	47675728	-	\$11.00	—	—	—

MORTISE LOCKS

605	606	611	612	613	619	622	625	626	626AM	628	629
US3	US4	US9	US10	US10B	US15	US19	US26	US26D	US26DAM	US28	US32
630	630AM	643e	689	691	693	695	706	710	711	721	728
US32D	US32DAM	-	SP28	SP10	SPBLK	SP313	SP4	313	315	US3A	US4A

MORTISE LOCKS

Description	Specify		630	605, 606, 622, 612, 613, 629
	Model number	Finish		
Standard Mortise Lock	7500	.[Finish]	\$945.00	\$977.00
Double Cylinder Mortise Lock	7500-2	.[Finish]	\$1,236.00	\$1,268.00
INPACT Device Mortise Lock	7500-IN	.[Finish]	\$1,176.00	\$1,207.00
Electric Unlocking Mortise Lock	E7500	.[Finish]	\$1,854.00	\$1,886.00
Signal Switch Mortise Lock	SS7500	.[Finish]	\$1,310.00	\$1,342.00
94/9575 Signal Switch Mortise Lock	SS7500-IN	.[Finish]	\$1,541.00	\$1,572.00

OPTIONS

E7500 - Furnished standard 24VDC if not specified. 12VDC available at no additional charge.	Specify (Prefix)	Price adjustment
<ul style="list-style-type: none"> AC requires SO12 or SO24 Rectifier Kit Available with TP, K, or L functions only SO rectifier kit intended for fail secure / momentary use only. Contact product support for assistance. 	24VAC or 12VAC	\$61.00
Fail Mode: FAIL SECURE (FSE) or FAIL SAFE (FS)	FSE or FS	\$0.00

CONNECTORS	Specify	Price adjustment
Cross-category solution using interconnect components for electrified options. Available for E7500 and SS7500 at no additional charge.	CON	\$0.00

Note: See catalog section on SS7500 or E7500 for required accessory equipment.

SWITCHES

REQUEST TO EXIT SWITCHES	Specify	Price each (Non-finished)
RX Switch Kit	050251-00	\$365.00
WP-RX-AUX Waterproof Switch Kit	051881-00	\$529.00
RX-LC Switch Kit	050281-00	\$424.00
RX-2 Switch Kit	050270-00	\$455.00
RX-Aux Switch Kit	050271-00	\$380.00

LATCH BOLT MONITORING SWITCHES	Specify	Price each (Non-finished)
LX Switch Kit 3' Device	050254-00	\$365.00
LX Switch Kit 4' Device	050255-00	\$365.00
LX-LC Switch Kit 3' Device	050283-00	\$424.00
LX-LC Switch Kit 4' Device	050285-00	\$424.00
EL-LX Switch Kit	050247-00	\$365.00
EL-LX-LC Switch Kit	050287-00	\$424.00

SWITCHES

605	606	611	612	613	619	622	625	626	626AM	628	629
US3	US4	US9	US10	US10B	US15	US19	US26	US26D	US26DAM	US28	US32
630	630AM	643e	689	691	693	695	706	710	711	721	728
US32D	US32DAM	-	SP28	SP10	SPBLK	SP313	SP4	313	315	US3A	US4A

REQUEST TO EXIT / LATCH BOLT MONITORING COMBINATION SWITCHES	Specify	Price each (Non-finished)
LX-RX Switch Kit 3' Device	050256-00	\$552.00
LX-RX Switch Kit 4' Device	050257-00	\$552.00
LX-RX-LC Switch Kit 3' Device	050289-00	\$665.00
LX-RX-LC Switch Kit 4' Device	050291-00	\$665.00
EL-LX-RX Switch Kit	050259-00	\$552.00
EL-LX-RX-LC Switch Kit	050293-00	\$665.00
LX 94/95 Switch Kit (After 4/2005)	050226-00	\$365.00

Consult technical support for details.

DELAYED EXIT SYSTEM

RELEASE DELAY	Specify	Price each
Logic Controller 15 Second Delay (furnished standard) ¹	DE5300	\$1,430.00
0 Second Delay [⌘]	0 Delay	\$194.00
30 Second Delay [⌘]	30 Delay	\$194.00
15 second delay with BOCA Modification [⌘]	BOCA-15 Delay	\$194.00
30 second delay with BOCA Modification [⌘]	BOCA-30 Delay	\$194.00

Note: Designed to meet NFPA 101 "Special Locking Arrangement" applications. A complete system requires several components not included with controller. Consult catalog for details.

¹ Over 15 second delay requires a letter of approval from the authority having local jurisdiction over the premises prior to the installation of the device. Allegion cannot grant such approval nor does it warrant local jurisdiction compliance.

[⌘] Consult factory for lead time.

INTERFACE BOXES/RELAYS

INTERFACE BOXES/RELAYS	Specify	Price each
Enclosure with terminal strip. Optional relays are available for factory or field installation.	JB7	\$988.00
FACTORY INSTALLED	Specify	Price each (per interface box)
24VDC SPDT	R1	\$427.00
24VDC DPDT	R2	\$427.00
24VDC DPDT Delay on Make Time Delay	R3	\$705.00
24VDC DPDT Delay on Break Time Delay	R4	\$705.00
PARTS (FIELD INSTALLABLE)	Specify	Price each
24VDC SPDT	Relay Kit R5	\$427.00
24VDC DPDT	Relay Kit R6	\$427.00
24VDC DPDT - Delay on Make Time Delay	Relay Kit R7	\$705.00
24VDC DPDT - Delay on Break Time Delay	Relay Kit R8	\$705.00

ALLEGION CONNECT

605	606	611	612	613	619	622	625	626	626AM	628	629
US3	US4	US9	US10	US10B	US15	US19	US26	US26D	US26DAM	US28	US32
630	630AM	643e	689	691	693	695	706	710	711	721	728
US32D	US32DAM	-	SP28	SP10	SPBLK	SP313	SP4	313	315	US3A	US4A

ALLEGION CONNECT HARNESSSES	Specify	Price each
MOLEX CONNECTORS ON BOTH ENDS (FOR USE WITH HOLLOW METAL DOORS)		
6" Wire Harness (internal p/n 106190-00)	CON-6	\$18.00
12" Wire Harness (internal p/n 106191-00)	CON-12	\$22.00
26" Wire Harness (internal p/n 106192-00)	CON-26	\$25.00
32" Wire Harness (internal p/n 106193-00)	CON-32	\$26.00
38" Wire Harness (internal p/n 106194-00)	CON-38	\$30.00
44" Wire Harness (internal p/n 106195-00)	CON-44	\$27.00
50" Wire Harness (internal p/n 106196-00)	CON-50	\$30.00
192" Wire Harness (internal p/n 106197-00)	CON-192	\$65.00
MOLEX CONNECTOR ON ONE END, CRIMPED PINS ON OTHER W/ ATTACHABLE MOLEX CONNECTOR (FOR USE WITH WOOD DOORS)		
6" Wire Harness (internal p/n 106201-00)	CON-6P	\$21.00
12" Wire Harness (internal p/n 106202-00)	CON-12P	\$26.00
26" Wire Harness (internal p/n 106203-00)	CON-26P	\$30.00
32" Wire Harness (internal p/n 106204-00)	CON-32P	\$32.00
38" Wire Harness (internal p/n 106205-00)	CON-38P	\$32.00
44" Wire Harness (internal p/n 106206-00)	CON-44P	\$33.00
50" Wire Harness (internal p/n 106207-00)	CON-50P	\$34.00
192" Wire Harness (internal p/n 106208-00)	CON-192P	\$69.00
MOLEX CONNECTOR ON ONE END, STRIPPED LEADS ON OTHER (FOR CONNECTION TO POWER SUPPLY)		
6" extension to power supply (internal p/n 106210-00)	CON-6W	\$21.00
SERVICE KIT		
Connector Service Kit (internal p/n 050823-00-00) contains: <ul style="list-style-type: none"> 100 each male & female terminals 10 each 4-pin and 8-pin male connectors 10 each 4-pin and 8-pin female connectors 1 extraction tool 	CON-KIT	\$166.00

Prices listed are net, discounting does not apply.

CON Adapter Harnesses for electrified hardware are located in the parts section with their corresponding products.

ELECTRIC POWER TRANSFERS

ELECTRIC POWER TRANSFERS					
Description	Specify		622	689	695
	Model number	Finish			
Two 18 gauge wires	EPT 2	.[Finish]	\$685.00	\$685.00	\$685.00
Ten 24 gauge wires	EPT 10	.[Finish]	\$729.00	\$729.00	\$729.00
"Buy America Act" compliant EPT option will be labeled as "Assembled in the U.S.A. with U.S. and foreign materials"	BAA	-	\$0.00	\$0.00	\$0.00
Connector (CON) is a cross category solution using common interconnect components for electrified options. Available for EPT10. Specify CON.	CON	-	\$16.00	\$16.00	\$16.00
PNT-1 - Pneumatic power transfer	012014-36	-	-	\$914.00	-

POWER SUPPLIES

605	606	611	612	613	619	622	625	626	626AM	628	629
US3	US4	US9	US10	US10B	US15	US19	US26	US26D	US26DAM	US28	US32
630	630AM	643e	689	691	693	695	706	710	711	721	728
US32D	US32DAM	-	SP28	SP10	SPBLK	SP313	SP4	313	315	US3A	US4A

1. SELECT POWER SUPPLY

DESCRIPTION	Specify	Price each
Base Power Supply (2A @ 12/24 VDC- field selectable) PS902 is able to accept a total of one optional distribution board, plus one fire alarm relay along with one battery backup board and up to two 7A/hr batteries	PS902	\$371.00
Base Power Supply (4A @ 12/24 VDC- field selectable) PS904 is able to accept a total of two optional distribution boards, plus one battery backup board and up to two 7A/hr batteries	PS904	\$702.00
Base Power Supply (6A @ 12/24 VDC- field selectable) PS906 is able to accept a total three optional distribution boards or two optional boards with battery backup board and two 7A/hr batteries	PS906	\$1,087.00
Base Power Supply (4A w/ 16A inrush @ 12/24 VDC- field selectable) PS914 is able to accept a total of two optional boards, plus one battery backup board and two 7A/hr batteries	PS914	\$1,064.00
The PS914RFK allows the retrofit of the PS914 into an existing PS873 cabinet.	PS914RFK	\$1,245.00
"Buy America Act" compliant power supply option will be labeled as "Assembled in the U.S.A. with U.S. and foreign materials"	BAA	\$57.00

NOTE: When specifying power supply with "EL" or "QEL" Electric Latch Retraction devices, the 2RS is furnished when board option is not specified.

2. SELECT OPTIONAL DISTRIBUTION BOARD WITH OR WITHOUT FA (FIRE ALARM RELAY)

DESCRIPTION	Model	Specify	Price each
Independently controlled relays	900-4R	44489912-00	\$250.00
Independently controlled relays with FA	900-4R-FA	4448912-00 & 44487247-00	\$342.00
2 Relay board output	900-2RS	44489896-00	\$254.00
2 Relay board output with FA	900-2RS-FA	44489896-00 & 44487247-00	\$347.00
4 Relay board integrated logic for controlling security interlocks, auto operators and time delays	900-4RL	44489920-00	\$688.00
4 Relay board integrated logic for controlling security interlocks, auto operators and time delays with FA	900-4RL-FA	44489920-00 & 44487247-00	\$780.00
8 fuse protected outputs	900-8F	44489946-00	\$92.00
8 fuse protected outputs with FA	900-8F-FA	44489946-00 & 44487247-00	\$185.00
8 PTC protected outputs	900-8P	44489938-00	\$92.00
8 PTC protected outputs with FA	900-8P-FA	44489938-00 & 44487247-00	\$185.00
Battery Backup Kit (includes two 7A/hr batteries)	900-BBK	44489961-00	\$359.00
Battery Backup board only (sold separately)	900-BB	44489953-00	\$181.00
Batteries only - (two 7A/hr batteries, sold separately)	900-BAT	44487155-00	\$181.00

NOTE: For field installation, use model number. Example: 900-2RS.

Standard Features

- UL294 Listed for Access Control
 - Class 2 rated power limited output*
 - Universal 120-240 VAC Input
 - Regulated and filtered DC outputs
 - AC input, battery and DC output LED indicators
 - Plug and play connectors for optional distribution boards
 - AC input status indication on outside cover
 - AC monitoring
 - 14" H x 12" W x 4" D enclosure
- * PS906 is Class 2 when used with 900-8P option board

POWER SUPPLIES

605	606	611	612	613	619	622	625	626	626AM	628	629
US3	US4	US9	US10	US10B	US15	US19	US26	US26D	US26DAM	US28	US32
630	630AM	643e	689	691	693	695	706	710	711	721	728
US32D	US32DAM	-	SP28	SP10	SPBLK	SP313	SP4	313	315	US3A	US4A

3. SELECT OTHER POWER SUPPLY OPTIONS

DESCRIPTION	Model	Specify	Price each
Fire Alarm Relay (EIR) module is a plug-in relay to provide an interface with fire or other emergency override systems <ul style="list-style-type: none"> PS902: may be installed directly on power supply or may be used with optional distribution boards PS904, PS906, PS914: must be used with optional distribution boards. If an optional board is not listed the 900-8F-FA will be provided. 	900-FA	44487247-00	\$92.00
Key Lock Cover (not available with BAA)	900-KL	44486850-00	\$58.00

Note: PS902, PS904, PS 906 and PS914 power supplies require connection to AC line voltage. Installation and all electrical connections (high and low voltage) should be performed by a qualified electrical contractor.

Standard Features

- UL294 Listed for Access Control
 - Class 2 rated power limited output*
 - Universal 120-240 VAC Input
 - Regulated and filtered DC outputs
 - AC input, battery and DC output LED indicators
 - Plug and play connectors for optional distribution boards
 - AC input status indication on outside cover
 - AC monitoring
 - 14" H x 12" W x 4" D enclosure
- * PS906 is Class 2 when used with 900-8P option board

ELECTRIC STRIKES

605	606	611	612	613	619	622	625	626	626AM	628	629
US3	US4	US9	US10	US10B	US15	US19	US26	US26D	US26DAM	US28	US32
630	630AM	643e	689	691	693	695	706	710	711	721	728
US32D	US32DAM	-	SP28	SP10	SPBLK	SP313	SP4	313	315	US3A	US4A

NOMENCLATURE – HOW TO ORDER

	Model	Power failure mode	Optional Dual switch	Voltage	Optional Rectifier kit	Optional Shim	Finish	Optional Buzzer	Allegion connect
	1	2	3	4	5	6	7	8	9
Specify for:	4200	-	-	-	4200	-	-	4200	-
	5100	-	-	-	5100	-	5100	5100	-
	6100	6100	6100	6100	6100	6100	6100	6100	6100
	6200	6200	6200	6200	6200	-	6200	6200	6200
	6300	-	-	-	6300	6300	-	6300	-
	6400	-	-	-	6400	-	-	6400	-

ELECTRIC STRIKES

605	606	611	612	613	619	622	625	626	626AM	628	629
US3	US4	US9	US10	US10B	US15	US19	US26	US26D	US26DAM	US28	US32
630	630AM	643e	689	691	693	695	706	710	711	721	728
US32D	US32DAM	-	SP28	SP10	SPBLK	SP313	SP4	313	315	US3A	US4A

4200 SERIES

4200 SERIES ELECTRIC STRIKES FOR CYLINDRICAL AND DEADLATCH LOCKS

Description	Throw	Fire Rated	Hollow Metal	Wood	Aluminum	Single	Mullion Pair	Model	Finish	630
4211 - Shallow 1-3/8" backbox depth	1/2"-3/4"		■		■	■		4211	[Finish]	\$285
4212 - Includes latch bolt monitor. Shallow backbox.	1/2"-5/8"		■		■	■		4212	[Finish]	\$342

OPTIONS

OPTIONS		Specify	Price each
SO12 Rectifier Kit	Converts 12 VAC to 12 VDC	12 VAC	\$61.00
SO24 Rectifier Kit	Converts 24 VAC to 24 VDC	24 VAC	\$61.00
Entry Buzzer	Use in fail-secure applications	EB	\$60.00
Faceplate, Round Corner	Additional faceplate option, square corner is standard in the box, both in BHMA 630/US32D satin stainless steel finish	090110	\$30.00

Refer to the Electric Strike Parts section for a complete list of available parts.

NOTE: SO rectifier kit intended for fail secure / momentary use only. Contact product support for assistance.

Features

- Field selectable fail-safe/fail-secure without disassembly
- Dual voltage: 12 VDC at 200 mA / 24 VDC at 100 mA
- Compatible with all Schlage and Falcon cylindrical locks as well as cylindrical and deadlatch locks of many other manufacturers

5100 SERIES

5100 SERIES ELECTRIC STRIKE FOR CYLINDRICAL AND DEADLATCH LOCKS

Description	Throw	Fire rated	Hollow metal	Wood	Aluminum	Single	Mullion pair	Model	Finish	689	622	695
5100 - 3 faceplates included with hardware for an all-in-one boxed solution	1/2"-5/8"		■	■	■	■		5100-3FP	[Finish]	\$369	\$369	\$369

OPTIONS

OPTIONS		Specify	Price each
SO12 Rectifier Kit	Converts 12 VAC to 12 VDC	12 VAC	\$61.00
SO24 Rectifier Kit	Converts 24 VAC to 24 VDC	24 VAC	\$61.00
Entry Buzzer	Use in fail-secure applications	EB	\$60.00

Refer to the Electric Strike Parts section for a complete list of available parts.

NOTE: SO rectifier kit intended for fail secure / momentary use only. Contact product support for assistance.

Features

- Adjustable keeper improves fit on tight door preps
- Field selectable fail-safe/fail-secure
- Dual voltage: 12 VDC at 380 mA / 24 VDC at 190 mA
- Compatible with Schlage and Falcon cylindrical and deadlatch locks including those of many other manufacturers
- UL 1034 burglary-resistant

ELECTRIC STRIKES

605	606	611	612	613	619	622	625	626	626AM	628	629
US3	US4	US9	US10	US10B	US15	US19	US26	US26D	US26DAM	US28	US32
630	630AM	643e	689	691	693	695	706	710	711	721	728
US32D	US32DAM	-	SP28	SP10	SPBLK	SP313	SP4	313	315	US3A	US4A

6100 SERIES

6100 SERIES ELECTRIC STRIKES FOR RIM EXIT DEVICES

Description	Throw	Fire rated	Hollow metal	Wood	Aluminum	Single	Mullion pair	Model	Finish	605	606	612	613	629	630
6111 - Can use with vertical rod exit devices	3/4"	■	■	■	■	■	■	6111	.[Finish]	\$1,387	\$1,301	\$1,346	\$1,346	\$1,312	\$1,277
6111-55R - Designed for use with 55 rim device only	3/4"	■	■	■	■	■	■	6111-55R	.[Finish]	\$1,387	\$1,301	\$1,346	\$1,346	\$1,312	\$1,277
6112 - Designed to replace FA 310-5 with minor frame modification	3/4"	■	■	■	■	■		6112	.[Finish]	\$1,304	\$1,218	\$1,263	\$1,263	\$1,229	\$1,194
6113 - Retrofits VD 3011, 3021	3/4"	■	■	■	■	■		6113	.[Finish]	\$1,387	\$1,301	\$1,346	\$1,346	\$1,312	\$1,277
6114 - Surface applied for use with rim nightlatch devices	3/4"		■		■	■		6114	.[Finish]	\$1,345	\$1,259	\$1,304	\$1,304	\$1,270	\$1,235
6121 - For rim exit devices on double doors without mullion ¹	3/4"		■	■	■		1	6121	.[Finish]	\$1,888	\$1,802	\$1,847	\$1,847	\$1,813	\$1,778

For options, please see list under 6200 Series section. Also, refer to the Electric Strike Parts section for a complete list of available parts.

Features

- Furnished standard in fail secure configuration unless specified fail safe (see options)
- 24 VDC supplied standard if not specified otherwise (see options)
- Compatible with Von Duprin and Falcon rim exit devices and those of many other manufacturers
- UL10C fire rated (fail secure only)
- UL1034 burglary-resistant

6200 SERIES

6200 SERIES ELECTRIC STRIKES FOR MORTISE OR CYLINDRICAL LOCKS

Description	Throw	Fire rated	Hollow metal	Wood	Aluminum	Single	Mullion pair	Model	Finish	605	606	612	613	629	630
6210 - Mortise only. Includes strike pocket inserts for deadlocking triggers	3/4"	■	■		■	■		6210	.[Finish]	\$1,273	\$1,187	\$1,232	\$1,232	\$1,198	\$1,163
6211 -Retrofits VD 3140 or FA 712	3/4"	■	■		■	■		6211	.[Finish]	\$1,205	\$1,119	\$1,164	\$1,164	\$1,130	\$1,095
6211AL - Retrofits FA 722	3/4"	■			■	■		6211AL	.[Finish]	\$1,249	\$1,163	\$1,208	\$1,208	\$1,174	\$1,139
6211WF - Retrofits FA 732 with minor frame modification	3/4"	■		■		■		6211WF	.[Finish]	\$1,218	\$1,132	\$1,177	\$1,177	\$1,143	\$1,108
6212 - Fits modified ANSI 115.2 cutout. Retrofits VD 3146.	3/4"	■	■		■	■		6212	.[Finish]	\$1,406	\$1,320	\$1,365	\$1,365	\$1,331	\$1,296
6212WF	3/4"	■		■		■		6212WF	.[Finish]	\$1,406	\$1,320	\$1,365	\$1,365	\$1,331	\$1,296
6213 - Retrofits VD 3041, 3042, 3061 and 3062	3/4"	■	■	Retrofits only	■	■		6213	.[Finish]	\$1,357	\$1,271	\$1,316	\$1,316	\$1,282	\$1,247
6214 - Retrofits FA 310-2-3/4	3/4"	■	■		■	■		6214	.[Finish]	\$1,535	\$1,449	\$1,494	\$1,494	\$1,460	\$1,425
6215 - Retrofits FA 310-2	3/4"	■	■		■	■		6215	.[Finish]	\$1,388	\$1,302	\$1,347	\$1,347	\$1,313	\$1,278
6216 - Retrofits FA 310-3-1. For mortise with manually operated deadbolt - 1" throw	3/4"	■	■	■	■	■		6216	.[Finish]	\$1,731	\$1,645	\$1,690	\$1,690	\$1,656	\$1,621
6221 - Retrofits VD 3071 and 3072. 4-3/4" minimum stile required	3/4"	■	■	■	■	■		6221	.[Finish]	\$1,542	\$1,456	\$1,501	\$1,501	\$1,467	\$1,432
6222 - Retrofits FA 310-2-3/4 OB	3/4"	■	■		■	■		6222	.[Finish]	\$1,923	\$1,837	\$1,882	\$1,882	\$1,848	\$1,813
6223 - Retrofits VD 3091 and 3092. 4-3/4" minimum stile required	3/4"	■	■	■	■	■		6223	.[Finish]	\$1,331	\$1,245	\$1,290	\$1,290	\$1,256	\$1,221

ELECTRIC STRIKES

605	606	611	612	613	619	622	625	626	626AM	628	629
US3	US4	US9	US10	US10B	US15	US19	US26	US26D	US26DAM	US28	US32
630	630AM	643e	689	691	693	695	706	710	711	721	728
US32D	US32DAM	-	SP28	SP10	SPBLK	SP313	SP4	313	315	US3A	US4A

6200 SERIES

6200 SERIES ELECTRIC STRIKES FOR MORTISE OR CYLINDRICAL LOCKS

Description	Throw	Fire rated	Hollow metal	Wood	Aluminum	Single	Mullion pair	Model	Finish	605	606	612	613	629	630
6224 - Retrofits FA 310-2-3/4. For door thicknesses 1-3/4" or 2-1/4"	3/4"	■	■		■		■	6224	[Finish]	\$1,555	\$1,469	\$1,514	\$1,514	\$1,480	\$1,445
6224AL - Retrofits FA 310-2RF. For door thicknesses 1-3/4" or 2-1/4"	3/4"	■			■		■	6224AL	[Finish]	\$1,575	\$1,489	\$1,534	\$1,534	\$1,500	\$1,465
6225 - Retrofits FA 310-2 OB	3/4"	■	■		■		■	6225	[Finish]	\$1,822	\$1,736	\$1,781	\$1,781	\$1,747	\$1,712
6226 - Retrofits FA 310-2. For door thicknesses 1-3/4" or 2-1/4"	3/4"	■	■		■		■	6226	[Finish]	\$1,331	\$1,245	\$1,290	\$1,290	\$1,256	\$1,221

OPTIONS

OPTIONS (PLEASE SPECIFY):		Specify	Price each
Fail Safe	Fail secure (FSE) is standard unless FS is specified	FS	\$59.00
Dual monitor switch	For latch bolt and lock status. Not available on 6221, 6222 & 6225	DS	\$290.00
Low current dual monitor switch	For latch bolt and lock status. 50 mA or less at 24 VDC (Not available on 6221, 6222 & 6225)	DS-LC	\$290.00
SO12 Rectifier Kit	Converts 12 VAC to 12 VDC (For 16 VAC current, use SO24 rectifier kit)	12 VAC	\$61.00
SO24 Rectifier Kit	Converts 24 VAC to 24 VDC	24 VAC	\$61.00
Shim for blade stop applications	Available as specified item with 6111 and 6113 only	SHIM	\$245.00
Entry Buzzer	Use in fail-secure applications	EB	\$60.00
Allegion Connect	6" wire extension harness connector	CON	\$0.00

Refer to the Electric Strike Parts section for a complete list of available parts.

NOTE: SO rectifier kit intended for fail secure / momentary use only. Contact product support for assistance.

Features

- Furnished standard in fail secure configuration unless specified fail safe (see options)
- 24 VDC supplied standard if not specified otherwise (see options)
- Compatible with mortise (without deadbolt) and cylindrical lock applications except where noted
- ANSI/BHMA 156.31 Grade 1: 6210, 6211, 6211AL, and 6211WF
- UL10C fire rated (fail secure only)
- UL1034 burglary-resistant

ELECTRIC STRIKES

605	606	611	612	613	619	622	625	626	626AM	628	629
US3	US4	US9	US10	US10B	US15	US19	US26	US26D	US26DAM	US28	US32
630	630AM	643e	689	691	693	695	706	710	711	721	728
US32D	US32DAM	-	SP28	SP10	SPBLK	SP313	SP4	313	315	US3A	US4A

6300 SERIES

6300 SERIES SURFACE MOUNT ELECTRIC STRIKE FOR RIM EXIT DEVICES

Description	Throw	Fire Rated	Hollow Metal	Wood	Aluminum	Single	Mullion Pair	Model	Finish	630
6300 - No cut, surface mount design	Up to 3/4"	■	■	■	■	■	■	6300	.[Finish]	\$1,097

OPTIONS

OPTIONS		Specify	Price each
1/16" Shim	Can be ordered separately as part 050804-00	SHIM	\$93.00
SO12 Rectifier Kit	Converts 12 VAC to 12 VDC	12 VAC	\$61.00
SO24 Rectifier Kit	Converts 24 VAC to 24 VDC	24 VAC	\$61.00
Entry Buzzer	Use in fail-secure applications	EB	\$60.00

Included with strike: two plug-in voltage connectors, mounting template, spacer plate, mounting screws, and hex wrench. Refer to the Electric Strike Parts section for a complete list of available parts.

NOTE: SO rectifier kit intended for fail secure / momentary use only. Contact product support for assistance.

Features

- Dual voltage: 12 VDC at 500 mA / 24 VDC at 240 mA
- UL 1034, UL 294, CSFM
- Compatible with most rim exit devices
- UL 10C 3-hour fire rated (fail secure only)

6400 SERIES

6400 SERIES MODULAR ELECTRIC STRIKE FOR MORTISE OR CYLINDRICAL LOCKS

Description	Throw	Fire Rated	Hollow Metal	Wood	Aluminum	Single	Mullion Pair	Model	Finish	630
6400 - Up to 1" deadbolt throw (must be manually retracted and extended)	Up to 3/4"	■	■	■	■	■		6400	.[Finish]	\$774

OPTIONS

OPTIONS		Specify	Price each
Latch Monitor	Optional plug-in latch monitor can be added in the field	LM6400	\$82.00
SO12 Rectifier Kit	Converts 12 VAC to 12 VDC	12 VAC	\$61.00
SO24 Rectifier Kit	Converts 24 VAC to 24 VDC	24 VAC	\$61.00
Entry Buzzer	Use in fail-secure applications	EB	\$60.00

Included with strike: two plug-in voltage connectors, self-adhesive template for frame cuts, trim filler plate, mounting tabs and shims, as well as tamper-resistant screws with a security driver bit.

NOTE: SO rectifier kit intended for fail secure / momentary use only. Contact product support for assistance.

Features

- Dual voltage: 12 VDC at 375 mA / 24 VDC at 190 mA
- UL 1034, UL 294, CSFM
- Modular options fit cylindrical and nearly any mortise lock
- 3-hour fire rated to UL 10C (fail secure only)
- Includes movable deadbolt keeper, plug and deadlatch ramp inserts.

ELECTRIC STRIKES

605	606	611	612	613	619	622	625	626	626AM	628	629
US3	US4	US9	US10	US10B	US15	US19	US26	US26D	US26DAM	US28	US32
630	630AM	643e	689	691	693	695	706	710	711	721	728
US32D	US32DAM	-	SP28	SP10	SPBLK	SP313	SP4	313	315	US3A	US4A

MONITOR STRIKES

MONITOR STRIKES									
Description	Specify		626	613	606, 612	605	625	629	630
	Model number	Finish							
For Rim and Surface Vertical type exit device as per catalog	4263-T1	.[Finish]	\$615.00	\$602.00	\$566.00	\$624.00	\$666.00	-	-
For Rim and Surface Vertical type exit device as per catalog	4263-T3	.[Finish]	\$615.00	\$602.00	\$566.00	\$624.00	\$666.00	-	-
For Rim type exit device as per catalog	4268-T1	.[Finish]	-	\$811.00	\$775.00	\$833.00	-	\$874.00	\$824.00
For Mortise Locks as per catalog - specify handing	4582-T1	.[Finish]	\$638.00	\$625.00	\$589.00	\$647.00	\$689.00	-	-
For Mortise Locks as per catalog - specify handing	4582-T2	.[Finish]	\$638.00	\$625.00	\$589.00	\$647.00	\$689.00	-	-
For Cylindrical Locks as per catalog	4570-T1	.[Finish]	\$638.00	\$625.00	\$589.00	\$647.00	\$689.00	-	-
For Cylindrical Locks as per catalog	4670-T1	.[Finish]	\$615.00	\$602.00	\$566.00	\$624.00	\$666.00	-	-
For Single 3347A, 3547A, 9847, and 9947	4690-T2	.[Finish]	\$928.00	\$915.00	\$879.00	\$937.00	\$979.00	-	-
Special Twin for 3347A and 3547A Device (2-1/4" cc)	4690-T2-1	.[Finish]	\$1,636.00	\$1,623.00	\$1,587.00	\$1,645.00	\$1,687.00	-	-

SCHLAGE® ELECTRONIC EXIT TRIM

AD Series Electronic Exit Trim is available on XP98/99 and Series 98/99 for rim, mortise, surface vertical, and concealed vertical rod/concealed vertical cable, and Series 22/22F for rim and surface vertical rod devices. For AD-300/400 network trim the Von Duprin RX-LC switch (part #050281) must be used or the warranty is void.

Four communication options:

- AD-200 993 Offline, access rights stored on lock.
- AD-250 993 Offline, access rights on stored magnetic stripe credential.
- AD-300 993 Networked Hardwire Locks
- AD-400 993 Networked Wireless Locks



For complete pricing information refer to Schlage Electronic Security Price Book.

NOTE: CVR/CVC trim is available only on metal doors.

PARTS AND ACCESSORIES

605	606	611	612	613	619	622	625	626	626AM	628	629
US3	US4	US9	US10	US10B	US15	US19	US26	US26D	US26DAM	US28	US32
630	630AM	643e	689	691	693	695	706	710	711	721	728
US32D	US32DAM	-	SP28	SP10	SPBLK	SP313	SP4	313	315	US3A	US4A

BOX ASSEMBLIES

Description	Part number	List price
6111, 6113, 6213 12VDC FS Box Assembly	111743	\$579.00
6111, 6113, 6213 12VDC FSE Box Assembly	111744	\$579.00
6111, 6113, 6213 24VDC FS Box Assembly	111745	\$579.00
6111, 6113, 6213 24VDC FSE Box Assembly	111746	\$579.00
6111, 6113, 6213 12VDC FS DS Box Assembly	111747	\$841.00
6111, 6113, 6213 12VDC FSE DS Box Assembly	111748	\$841.00
6111, 6113, 6213 24VDC FS DS Box Assembly	111749	\$841.00
6111, 6113, 6213 24VDC FSE DS Box Assembly	111750	\$841.00
6111, 6113, 6213 12VDC FS DS-LC Box Assembly	112772	\$841.00
6111, 6113, 6213 12VDC FSE DS-LC Box Assembly	112773	\$841.00
6111, 6113, 6213 24VDC FS DS-LC Box Assembly	112774	\$841.00
6111, 6113, 6213 24VDC FSE DS-LC Box Assembly	112775	\$841.00
6112, 6121 12VDC FS Box Assembly	111751	\$566.00
6112, 6121 12VDC FSE Box Assembly	111752	\$566.00
6112, 6121 24VDC FS Box Assembly	111753	\$566.00
6112, 6121 24VDC FSE Box Assembly	111754	\$566.00
6112, 6121 12VDC FS DS Box Assembly	111755	\$823.00
6112, 6121 12VDC FSE DS Box Assembly	111756	\$823.00
6112, 6121 24VDC FS DS Box Assembly	111757	\$823.00
6112, 6121 24VDC FSE DS Box Assembly	111758	\$823.00
6112, 6121 12VDC FS DS-LC Box Assembly	112776	\$823.00
6112, 6121 12VDC FSE DS-LC Box Assembly	112777	\$823.00
6112, 6121 24VDC FS DS-LC Box Assembly	112778	\$823.00
6112, 6121 24VDC FSE DS-LC Box Assembly	112779	\$823.00
6114, 6214/15, 6222/24/24AL/25/26 12VDC FS Box Assembly	111719	\$637.00
6114, 6214/15, 6222/24/24AL/25/26 12VDC FSE Box Assembly	111720	\$637.00
6114, 6214/15, 6222/24/24AL/25/26 24VDC FS Box Assembly	111721	\$637.00
6114, 6214/15, 6222/24/24AL/25/26 24VDC FSE Box Assembly	111722	\$637.00
6114, 6214/15, 6224/24AL/26 12VDC FS DS Box Assembly	111723	\$901.00
6114, 6214/15, 6224/24AL/26 12VDC FSE DS Box Assembly	111724	\$901.00
6114, 6214/15, 6224/24AL/26 24VDC FS DS Box Assembly	111725	\$901.00
6114, 6214/15, 6224/24AL/26 24VDC FSE DS Box Assembly	111726	\$901.00
6114, 6214/15/24/24AL/26 12VDC FS DS-LC Box Assembly	112760	\$901.00
6114, 6214/15/24/24AL/26 12VDC FSE DS-LC Box Assembly	112761	\$901.00
6114, 6214/15/24/24AL/26 24VDC FS DS-LC Box Assembly	112762	\$901.00
6114, 6214/15/24/24AL/26 24VDC FSE DS-LC Box Assembly	112763	\$901.00
6210 12VDC FS Box Assembly	111244	\$942.00
6210 12VDC FSE Box Assembly	111246	\$578.00
6210 24VDC FS Box Assembly	111247	\$653.00
6210 24VDC FSE Box Assembly	111250	\$474.00
6210 12VDC FS DS Box Assembly	111251	\$1,200.00

PARTS AND ACCESSORIES

605	606	611	612	613	619	622	625	626	626AM	628	629
US3	US4	US9	US10	US10B	US15	US19	US26	US26D	US26DAM	US28	US32
630	630AM	643e	689	691	693	695	706	710	711	721	728
US32D	US32DAM	-	SP28	SP10	SPBLK	SP313	SP4	313	315	US3A	US4A

BOX ASSEMBLIES

Description	Part number	List price
6210 12VDC FSE DS Box Assembly	111264	\$839.00
6210 24VDC FS DS Box Assembly	111813	\$922.00
6210 24VDC FSE DS Box Assembly	111814	\$922.00
6210 12VDC FS DS-LC Box Assembly	112754	\$853.00
6210 12VDC FSE DS-LC Box Assembly	112755	\$853.00
6210 24VDC FS DS-LC Box Assembly	112784	\$853.00
6210 24VDC FSE DS-LC Box Assembly	112785	\$853.00
6211, 6211AL, 6212 12VDC FS Box Assembly	111711	\$545.00
6211, 6211AL, 6212 12VDC FSE Box Assembly	111712	\$545.00
6211, 6211AL, 6212 24VDC FS Box Assembly	111713	\$545.00
6211, 6211AL, 6212 24VDC FSE Box Assembly	111714	\$545.00
6211, 6211AL, 6212 12VDC FS DS Box Assembly	111715	\$812.00
6211, 6211AL, 6212 12VDC FSE DS Box Assembly	111716	\$812.00
6211, 6211AL, 6212 24VDC FS DS Box Assembly	111717	\$812.00
6211, 6211AL, 6212 24VDC FSE DS Box Assembly	111718	\$812.00
6211WF, 6212WF 12VDC FS Box Assembly	111727	\$578.00
6211WF, 6212WF 12VDC FSE Box Assembly	111728	\$578.00
6211WF, 6212WF 24VDC FS Box Assembly	111729	\$578.00
6211WF, 6212WF 24VDC FSE Box Assembly	111730	\$578.00
6211WF, 6212WF 12VDC FS DS Box Assembly	111731	\$839.00
6211WF, 6212WF 12VDC FSE DS Box Assembly	111732	\$839.00
6211WF, 6212WF 24VDC FS DS Box Assembly	111733	\$839.00
6211WF, 6212WF 24VDC FSE DS Box Assembly	111734	\$839.00
6211WF, 6212WF 12VDC FS DS-LC Box Assembly	112764	\$839.00
6211WF, 6212WF 12VDC FSE DS-LC Box Assembly	112765	\$839.00
6211WF, 6212WF 24VDC FS DS-LC Box Assembly	112766	\$839.00
6211WF, 6212WF 24VDC FSE DS-LC Box Assembly	112767	\$839.00
6211, 6211AL, 6212 12VDC FS DS-LC Box Assembly	112756	\$812.00
6211, 6211AL, 6212 12VDC FSE DS-LC Box Assembly	112757	\$812.00
6211, 6211AL, 6212 24VDC FS DS-LC Box Assembly	112758	\$812.00
6211, 6211AL, 6212 24VDC FSE DS-LC Box Assembly	112759	\$812.00
6216 12VDC FS Box Assembly	111759	\$579.00
6216 12VDC FSE Box Assembly	111760	\$579.00
6216 24VDC FS Box Assembly	111761	\$579.00
6216 24VDC FSE Box Assembly	111762	\$579.00
6216 12VDC FS DS Box Assembly	111763	\$841.00
6216 12VDC FSE DS Box Assembly	111764	\$841.00
6216 24VDC FS DS Box Assembly	111765	\$841.00
6216 24VDC FSE DS Box Assembly	111766	\$841.00
6216 12VDC FS DS-LC Box Assembly	112780	\$841.00
6216 12VDC FSE DS-LC Box Assembly	112781	\$841.00

PARTS AND ACCESSORIES

605	606	611	612	613	619	622	625	626	626AM	628	629
US3	US4	US9	US10	US10B	US15	US19	US26	US26D	US26DAM	US28	US32
630	630AM	643e	689	691	693	695	706	710	711	721	728
US32D	US32DAM	-	SP28	SPI0	SPBLK	SP313	SP4	313	315	US3A	US4A

BOX ASSEMBLIES

Description	Part number	List price
6216 24VDC FS DS-LC Box Assembly	112782	\$841.00
6216 24VDC FSE DS-LC Box Assembly	112783	\$841.00
6221, 6223 12VDC FS Box Assembly	111735	\$595.00
6221, 6223 12VDC FSE Box Assembly	111736	\$595.00
6221, 6223 24VDC FS Box Assembly	111737	\$595.00
6221, 6223 24VDC FSE Box Assembly	111738	\$595.00
6223 12VDC FS DS Box Assembly	111739	\$861.00
6223 12VDC FSE DS Box Assembly	111740	\$861.00
6223 24VDC FS DS Box Assembly	111741	\$861.00
6223 24VDC FSE DS Box Assembly	111742	\$861.00
6223 12VDC FS DS-LC Box Assembly	112768	\$861.00
6223 12VDC FSE DS-LC Box Assembly	112769	\$861.00
6223 24VDC FS DS-LC Box Assembly	112770	\$861.00
6223 24VDC FSE DS-LC Box Assembly	112771	\$861.00

DUAL MONITOR SWITCH REPLACEMENT KITS

Description	Part number	List price
6100, 6200 DS Replacement Kit Type A – Standard Back Box	050011	\$320.00
6100, 6200 DS Replacement Kit Type B – Special Back Box	050015	\$326.00
6100, 6200 DS-LC Replacement Kit Type A – Standard Back Box	050016	\$326.00
6100, 6200 DS-LC Replacement Kit Type B – Special Back Box	050018	\$326.00

FACEPLATES

Description	Specify		622, 689, 695	630	612, 613	606	605	629
	Part number	Finish						
4200 Faceplate, Round Corner	090110	.[Finish]	-	\$30.00	-	-	-	-
4200 Faceplate, Square Corner	090114	.[Finish]	-	\$30.00	-	-	-	-
5100 Faceplate Package - Standard 4 7/8"	050031	-	\$41.00	-	-	-	-	-
5100 Faceplate Package - Round Corner 4 7/8"	050032	-	\$41.00	-	-	-	-	-
5100 Faceplate Package – Long 7 15/16"	050033	-	\$41.00	-	-	-	-	-
6111 Faceplate	970271	.[Finish]	-	\$595.00	\$654.00	\$595.00	\$815.00	\$684.00
6112, 6121 Faceplate	970303	.[Finish]	-	\$542.00	\$700.00	\$542.00	\$824.00	\$482.00
6113 Faceplate	970280	.[Finish]	-	\$589.00	\$610.00	\$589.00	\$798.00	\$610.00
6114 Faceplate	970300	.[Finish]	-	\$492.00	\$607.00	\$551.00	\$684.00	\$510.00
6210 Faceplate	971198	.[Finish]	-	\$406.00	\$574.00	\$406.00	\$650.00	\$551.00
6211AL Faceplate	970272	.[Finish]	-	\$517.00	\$607.00	\$517.00	\$730.00	\$529.00
6211, 6211WF Faceplate	968716	.[Finish]	-	\$427.00	\$488.00	\$427.00	\$611.00	\$435.00
6212, 6212WF Faceplate	969584	.[Finish]	-	\$611.00	\$686.00	\$611.00	\$752.00	\$695.00
6213 Faceplate	970278	.[Finish]	-	\$567.00	\$616.00	\$567.00	\$762.00	\$616.00
6214 Faceplate	971417	.[Finish]	-	\$671.00	\$712.00	\$651.00	\$910.00	\$700.00
6215 Faceplate	971415	.[Finish]	-	\$541.00	\$607.00	\$541.00	\$712.00	\$551.00
6216 Large Faceplate Insert	970407	.[Finish]	-	\$158.00	\$185.00	\$158.00	\$222.00	\$192.00

PARTS AND ACCESSORIES

605	606	611	612	613	619	622	625	626	626AM	628	629
US3	US4	US9	US10	US10B	US15	US19	US26	US26D	US26DAM	US28	US32
630	630AM	643e	689	691	693	695	706	710	711	721	728
US32D	US32DAM	-	SP28	SPI0	SPBLK	SP313	SP4	313	315	US3A	US4A

FACEPLATES								
Description	Specify		622, 689, 695	630	612, 613	606	605	629
	Part number	Finish						
6216 Small Faceplate Insert	970415	.[Finish]	-	\$158.00	\$185.00	\$158.00	\$222.00	\$192.00
6216 Faceplate Less Inserts	971385	.[Finish]	-	\$739.00	\$776.00	\$739.00	\$1,043.00	\$718.00
6221 Faceplate	970276	.[Finish]	-	\$719.00	\$790.00	\$719.00	\$862.00	\$820.00
6222 Faceplate	970305	.[Finish]	-	\$1,041.00	\$1,106.00	\$1,041.00	\$1,409.00	\$1,041.00
6223 Faceplate	970274	.[Finish]	-	\$517.00	\$596.00	\$517.00	\$746.00	\$596.00
6224 Faceplate	970302	.[Finish]	-	\$691.00	\$723.00	\$671.00	\$928.00	\$716.00
6224AL Faceplate	970310	.[Finish]	-	\$712.00	\$786.00	\$712.00	\$988.00	\$723.00
6225 Faceplate	970306	.[Finish]	-	\$940.00	\$996.00	\$940.00	\$1,135.00	\$1,041.00
6226 Faceplate	970301	.[Finish]	-	\$482.00	\$546.00	\$482.00	\$705.00	\$496.00

SCREW AND MOUNTING PACKAGES								
Description	Specify		Non-finished	630	612, 613	606	605	629
	Part number	Finish						
4200 Hardware Kit (includes: mounting tab hardware, mounting screws, allen wrench and diode)	050805	-	\$24.00	-	-	-	-	-
5100 Mounting Package	PKGMTG.1004	.[Finish]	-	\$21.00	-	-	-	-
5100 Mounting Package (Black)	PKGMTG.1005	-	\$21.00	-	-	-	-	-
5100 Series Screw Package	PKGSCR.1003	.[Finish]	-	\$21.00	-	-	-	-
5100 Series Screw Package (Black)	PKGSCR.1004	-	\$21.00	-	-	-	-	-
6111, 6113 Screw Package	900870	.[Finish]	-	\$19.00	\$19.00	\$19.00	\$19.00	\$19.00
6112, 6121 Screw Package	900881	.[Finish]	-	\$20.00	\$21.00	\$21.00	\$21.00	\$20.00
6114 Screw Package	900882	.[Finish]	-	\$20.00	\$21.00	\$21.00	\$21.00	\$20.00
6210 Strike Pocket Insert Mounting Package	900966	-	\$18.00	-	-	-	-	-
6210/11/13/14/16, 6222/24/25/26 Screw Package	900288	.[Finish]	-	\$21.00	\$21.00	\$21.00	\$21.00	\$21.00
6211WF, 6212WF, 6221/23 Screw Package	900885	.[Finish]	-	\$19.00	\$19.00	\$19.00	\$19.00	\$19.00
6212 Screw Package	900290	.[Finish]	-	\$20.00	\$20.00	\$20.00	\$20.00	\$20.00
6216 Inserts and Screw Package	900345	-	\$387.00	-	-	-	-	-
Screw: 8-32 x 3/8" PPHMS	964070	-	\$17.00	-	-	-	-	-
Screw: 6-32 x 3/8" PPHMS Type 2A	964190	-	\$17.00	-	-	-	-	-

SOLENOID PARTS		
Description	Part number	List price
5100 Solenoid Kit 12/24VDC	050034	\$110.00
6100, 6200 Series Solenoid Kit 12VDC (FS & FSE)	050237	\$170.00
6100, 6200 Series Solenoid Kit 16 VDC (FS & FSE)	050239	\$170.00
6100, 6200 Series Solenoid Kit 24VDC (FS & FSE)	050240	\$170.00
6100, 6200 Series Solenoid Kit 28VDC	050699	\$166.00
Solenoid Spring	968713	\$20.00
Solenoid Washer	964037	\$17.00

PARTS AND ACCESSORIES

605	606	611	612	613	619	622	625	626	626AM	628	629
US3	US4	US9	US10	US10B	US15	US19	US26	US26D	US26DAM	US28	US32
630	630AM	643e	689	691	693	695	706	710	711	721	728
US32D	US32DAM	-	SP28	SP10	SPBLK	SP313	SP4	313	315	US3A	US4A

SPRING KITS

Description	Part number	List price
6111/13, 6213, 6221/23 Spring Kit	050942	\$50.00
6112/14/21, 6214/15/22/24/24AL/25/26 Spring Kit	050943	\$50.00
6210 Spring Kit	050940	\$60.00
6211/12 Spring Kit	050939	\$50.00
6216 Spring Kit	050941	\$60.00

MISCELLANEOUS HARDWARE

Description	Specify		Non-finished	606, 612, 613, 630	605	629	689 695
	Part number	Finish					
#8 Ext. Tooth Lock Washer	964019	-	\$17.00	-	-	-	-
4200 Hardware Kit (includes: mounting tab hardware, mounting screws, allen wrench and diode)	050805	-	\$24.00	-	-	-	-
Entry Buzzer (FSE application only)	050242	-	\$60.00	-	-	-	-
12 VAC to 12 VDC Rectifier Kit	010057	-	\$61.00	-	-	-	-
24 VAC to 24 VDC Rectifier Kit	010058	-	\$61.00	-	-	-	-
6100, 6200 Series DS-LC Switch and Clip Assembly	113232	-	\$260.00	-	-	-	-
6111, 6113 Shim for blade stop applications	010055	.[Finish]	-	-	-	-	\$245.00
6113 Frame Insert Package	900347	-	\$18.00	-	-	-	-
6121 Housing Cover	970412	.[Finish]	-	\$521.00	\$685.00	\$700.00	-
6210 Auxiliary Bolt Plate Package	900584	-	\$58.00	-	-	-	-
6212 Strike Pocket Insert/Mounting Tab	900292	-	\$42.00	-	-	-	-
6216 Inserts and Screw Package	900345	-	\$387.00	-	-	-	-
6300, 6400 Cable (Pigtail) Kit	050803	-	\$76.00	-	-	-	-
6300 Strike Shim - 1/16"	050804	-	\$93.00	-	-	-	-
6100, 6200 (9100) Filler Bracket Kit	050749	-	\$79.00	-	-	-	-
Connector	990132	-	\$18.00	-	-	-	-
DS Tripper Extension & Connector	900344	-	\$42.00	-	-	-	-
DS Tripper Extension	970384	-	\$18.00	-	-	-	-
FS Slider (All 6100 and 6200 Series models except 6211WF/6212WF/6221/6223)	090591	-	\$50.00	-	-	-	-
FSE Slider (Models 6211WF/6212WF/6221/6223)	090591	-	\$50.00	-	-	-	-
FSE Slider (All 6100 and 6200 Series models except 6211WF/6212WF/6221/6223)	090798	-	\$50.00	-	-	-	-
FS Slider (Models 6211WF/6212WF/6221/6223)	090798	-	\$50.00	-	-	-	-
6400 Hardware Kit	050819	-	\$118.00	-	-	-	-

ELECTRIFIED KITS

605	606	611	612	613	619	622	625	626	626AM	628	629
US3	US4	US9	US10	US10B	US15	US19	US26	US26D	US26DAM	US28	US32
630	630AM	643e	689	691	693	695	706	710	711	721	728
US32D	US32DAM	-	SP28	SP10	SPBLK	SP313	SP4	313	315	US3A	US4A

PARTS AND ACCESSORIES

ELECTRIC LATCH RETRACTION		
Description	Part number	List price
EL Dogging Rod - 3'	050531	\$92.00
EL Dogging Rod - 4'	050532	\$92.00
EL Dogging Rod Retainer	050538	\$21.00
EL Solenoid & Plunger	050535	\$510.00
EL Plunger Bracket-94/95	972471	\$44.00
Pulse Width Module	050534	\$483.00
QEL/MEL motor cable with 6' harness	47269206	\$67.00
EL Receptacle Connector	050539	\$20.00
EL Female Terminal	050540	\$20.00
QEL Cable Package (includes short QEL motor cable)	114320	\$19.00
QEL Motor Cable with QEL CON Adapter Harness	040069	\$84.00
6000 Strike Solenoid CON Adapter Harness	106187	\$21.00
E7500 Solenoid/QEL/EL CON Adapter Harness	106198	\$19.00
EL Baseplate Conversion Kit 3'	050070	\$1,555.00
EL Baseplate Conversion Kit 4'	050078	\$1,555.00
EL Baseplate Conversion Kit 3' with Allegion Connect - CON	050853	\$1,555.00
EL Baseplate Conversion Kit 4' with Allegion Connect - CON	050854	\$1,555.00
QEL Modular Conversion Kit	114317	\$1,258.00
QEL Modular Conversion Kit with Allegion Connect - CON	040061	\$1,258.00
QELX Modular Conversion Kit for AX devices	041162	\$1,338.00
QELX Modular Conversion Kit for AX devices with Allegion Connect -CON	041163	\$1,338.00
HD-QEL Modular Conversion Kit (Hex Dogging included - Panic Only)	958002	\$1,258.00
HD-QEL Modular Conversion Kit (Hex Dogging included - Panic Only) with Allegion Connect - CON	040062	\$1,258.00
HD-QELX Modular Conversion Kit for AX devices (Hex Dogging Included - Panic Only)	041164	\$1,338.00
HD-QELX Modular Conversion Kit for AX devices (Hex Dogging Included - Panic Only) with Allegion Connect -CON	041165	\$1,338.00
QEL Baseplate Conversion Kit 3'	958003	\$1,323.00
QEL Baseplate Conversion Kit 4'	040065	\$1,323.00
QEL Baseplate Conversion Kit 3' with Allegion Connect - CON	040063	\$1,323.00
QEL Baseplate Conversion Kit 4' with Allegion Connect - CON	040066	\$1,323.00
QELX Baseplate Conversion Kit for AX devices 3'	041166	\$1,402.00
QELX Baseplate Conversion Kit for AX devices 4'	041167	\$1,402.00
QELX Baseplate Conversion Kit for AX devices 3' with Allegion Connect -CON	041168	\$1,402.00
QELX Baseplate Conversion Kit for AX devices 4' with Allegion Connect -CON	041169	\$1,402.00
HD-QEL Baseplate Conversion Kit 3' (Hex Dogging included - Panic Only)	958004	\$1,323.00
HD-QEL Baseplate Conversion Kit 4' (Hex Dogging included - Panic Only)	040067	\$1,323.00
HD-QEL Baseplate Conversion Kit 3' (Hex Dogging included - Panic Only) with Allegion Connect - CON	040064	\$1,323.00
HD-QEL Baseplate Conversion Kit 4' (Hex Dogging included - Panic Only) with Allegion Connect - CON	040068	\$1,323.00
HD-QELX Baseplate Conversion Kit for AX devices 3' (Hex Dogging Included - Panic Only)	041170	\$1,402.00

PARTS AND ACCESSORIES

605	606	611	612	613	619	622	625	626	626AM	628	629
US3	US4	US9	US10	US10B	US15	US19	US26	US26D	US26DAM	US28	US32
630	630AM	643e	689	691	693	695	706	710	711	721	728
US32D	US32DAM	-	SP28	SPI0	SPBLK	SP313	SP4	313	315	US3A	US4A

ELECTRIC LATCH RETRACTION

Description	Part number	List price
HD-QELX Baseplate Conversion Kit for AX devices 4' (Hex Dogging Included - Panic Only)	041171	\$1,402.00
HD-QELX Baseplate Conversion Kit for AX devices 3' (Hex Dogging Included - Panic Only) with Allegion Connect -CON	041172	\$1,402.00
HD-QELX Baseplate Conversion Kit for AX devices 4' (Hex Dogging Included - Panic Only) with Allegion Connect -CON	041173	\$1,402.00
QEL 94/95 Inpact Modular Conversion Kit	958005	\$1,258.00
QEL/MEL Motor Cable with 6' Harness	47269206	\$84.00

PNEUMATIC LATCH RETRACTION

Description	Part number	List price
Pneumatic Power Transfer	012014	\$914.00
PN 5/32" Tubing - 25'	051828	\$36.00
PN 5/32" Tubing - 50'	051823	\$47.00
PN 5/32" Tubing - 100'	051824	\$80.00
PN 5/32" Tubing - 200'	051825	\$151.00
Pneumatic Solenoid Kit (For Devices Shipped After 2015)	051826	\$1,216.00
PN Adapter Kit - 5/32" to 1/4" LCN Tubing	051827	\$55.00

CHEXIT

Description	Specify		Non-finished	605, 606, 612, 625, 628	643E, 693, 710, 711	619 630
	Part number	Finish				
Chexit PCB Kit - 15 second release	040086	-	\$1,511.00	-	-	-
Chexit PCB Kit - 30 second release	040088	-	\$1,709.00	-	-	-
Chexit PCB KIT - 0 Second Delay release	040089	-	\$1,709.00	-	-	-
Chexit PCB Kit - 15 Second Boca release	040091	-	\$1,709.00	-	-	-
Chexit CON Adapter Harness	116724	-	\$146.00	-	-	-
Chexit PCB Kit - Infinite Release	040087	-	\$1,709.00	-	-	-
DE5300/RCM PCB Kit - 15 Second release	090943	-	\$1,435.00	-	-	-
DE5300/RCM Key Switch Assy	040169	-	\$183.00	-	-	-
DE5300/RCM PCB Kit - 0 Second release	050899	-	\$1,636.00	-	-	-
RCM/DE5300 Cable Kit	040188	-	\$168.00	-	-	-
CX99-RCM Kit Less Module	040198	.[Finish]	-	\$381.00	\$381.00	-
CX98-RCM Kit Less Module	040199	.[Finish]	-	\$381.00	\$381.00	\$381.00
CX-RCM Cable Assy	040092	-	\$101.00	-	-	-
Chexit Wiring Assembly	040191	-	\$290.00	-	-	-
CXA FLD Wiring Cable 10'	114905	-	\$163.00	-	-	-
Sign 15 Second - Chexit/DE5300	113781	-	\$84.00	-	-	-
Sign 30 Second - Chexit/DE5300	113782	-	\$92.00	-	-	-
CX Motor Cable Kit	040192	-	\$19.00	-	-	-
CX Trim Device Cable Kit	040193	-	\$35.00	-	-	-
CX RX Switch Assembly Kit	116717	-	\$348.00	-	-	-
CX Key Switch Assy 3' Device	040170	-	\$174.00	-	-	-

PARTS AND ACCESSORIES

605	606	611	612	613	619	622	625	626	626AM	628	629
US3	US4	US9	US10	US10B	US15	US19	US26	US26D	US26DAM	US28	US32
630	630AM	643e	689	691	693	695	706	710	711	721	728
US32D	US32DAM	-	SP28	SP10	SPBLK	SP313	SP4	313	315	US3A	US4A

CHEXIT

Description	Specify		Non-finished	605, 606, 612, 625, 628	643E, 693, 710, 711	619 630
	Part number	Finish				
CX Key Switch Assy 4' Device	040189	-	\$174.00	-	-	-
CX Wire Guard	47267412	-	\$64.00	-	-	-
CX-S Key Switch Spacer Pkg/10	47395815	-	\$15.00	-	-	-

SWITCH

Description	Part number	List price
LX-RX 94/95 Switch Wire Assembly (R/Y/B)	110360	\$165.00
SS Cable	050544	\$201.00
SS Housing	050545	\$670.00
RX Switch Assy	050251	\$365.00
RX-LC Switch Assy	050281	\$424.00
RX-2 Switch Assy	050270	\$455.00
RX-Aux Switch Assy	050271	\$380.00
WP-RX-AUX Switch Assy	051881	\$529.00
LX Switch Assy 3'	050254	\$365.00
LX Switch Assy 4'	050255	\$365.00
LX-LC Switch Assy 3'	050283	\$424.00
LX-LC Switch Assy 4'	050285	\$424.00
LX-RX Switch Assy 3'	050256	\$552.00
LX-RX Switch Assy 4'	050257	\$552.00
LX-RX-LC Switch Assy 3'	050289	\$665.00
LX-RX-LC Switch Assy 4'	050291	\$665.00
EL-LX Switch Assy	050247	\$365.00
EL-LX-LC Switch Assy	050287	\$424.00
EL-LX-RX Switch Assy	050259	\$552.00
EL-LX-RX-LC Switch Assy	050293	\$665.00
94/95 Inpact LX Switch Kit	050226	\$365.00

Consult technical support for details.

PARTS AND ACCESSORIES

605	606	611	612	613	619	622	625	626	626AM	628	629
US3	US4	US9	US10	US10B	US15	US19	US26	US26D	US26DAM	US28	US32
630	630AM	643e	689	691	693	695	706	710	711	721	728
US32D	US32DAM	-	SP28	SP10	SPBLK	SP313	SP4	313	315	US3A	US4A

E360 CONTROLS

Description	Specify		Non-finished	689, 695
	Part number	Finish		
E360 FSE Solenoid Kit	050743	-	\$928.00	-
E360 FS Solenoid Kit	050744	-	\$928.00	-

M996 TRIMS

Description	Specify		Non-finished	689, 695
	Part number	Finish		
M996 Mort Conv to Motorized Kit	47273112	-	\$1,040.00	-
M996 R/V/C Conv to Motorized Kit	47273111	-	\$998.00	-
M996 Wire Harness	CABLE.10038	-	\$69.00	-
M996 CON Adapter Harness	106183	-	\$49.00	-

MISCELLANEOUS

Description	Specify		Non-finished	689, 695
	Part number	Finish		
Switch Cover Assy - 4000 Monitor Strikes	105100	-	\$192.00	-
EPT Filler Kit	900978	.[Finish]	-	\$42.00
900-BAT Power Supply Batteries	44487155	-	\$176.00	-

OLD P/N	NEW P/N	OLD P/N	NEW P/N	OLD P/N	NEW P/N	OLD P/N	NEW P/N
213	050342	101801	050456	106769	050316	111948	113100
011214	050338	101907	050418	106769	050318	111949	050506
011223	050343	102274	050139	106769	050324	111950	050504
011224	050339	102277	050137	106769	050326	112342	050575
011233	050340	102551	050036	106780	050493	112461	111869
011234	050336	102676	050462	107021	050750	112727	050491
011243	050341	102681	050463	107023	050592	112906	050494
011244	050337	102685	050432	107682	050451	112907	050495
011253	050350	102691	050430	107798	050456	112910	050583
011254	050346	102694	050431	108327	050402	112915	050535
011263	050351	102701	050446	108360	050513	112924	050401
011264	050347	102703	050202	108361	050515	112925	050400
011273	050348	102930	114141	108994	PBKIT.1001	113004	050732
011274	050344	103234	050455	108994	PBKIT.1002	113005	050733
011283	050349	104154	050411	108995	PBKIT.1003	113006	050734
011284	050345	104164	050428	108995	PBKIT.1004	113007	050736
050361	050360	104165	050429	109041	050537	113078	050737
061420	050005	104367	050210	109160	050128	113079	050738
062370	050459	104759	050053	109759	050492	113080	050739
090058	090065	105020	050457	109760	050754	113081	050741
100511	050200	105163	050110	109811	900620	113125	050548
100693	050209	105641	050096	109826	050366	113126	050549
100729	050439	105666	050458	109861	050357	113129	050550
100744	050438	106118	050440	110007	050531	113130	050551
100751	050497	106122	050441	110008	050532	113133	050552
100999	050442	106144	050372	110051	050401	113134	050553
101000	050443	106145	050374	110052	050400	114169	050516
101011	050201	106147	050373	110058	050402	945501	090001
101134	050112	106174	050437	110163	050756	950522	090012
101137	050136	106180	050452	110165	050757	951081	050476
101149	050368	106708	050295	110375	050574	951780	090013
101190	050367	106708	050296	110416	050582	951960	050501
101444	050444	106708	050297	110472	050544	951970	050502
101445	050445	106708	050298	-	-	952400	050448
101590	050498	106708	050303	110573	050512	952530	050447
101593	050424	106708	050304	110574	050514	956011	PKGSRV.1018
101594	050425	106708	050305	110658	050545	956520	090020
101598	050426	106708	050306	110740	050536	957750	050278
101599	050427	106725	050299	110741	050534	958643	090014
101648	050482	106725	050300	-	-	959098	113853
101662	050409	106725	050301	-	-	959122	972466
101665	050410	106725	050302	111645	050752	959707	971593
101686	050413	106725	050307	111651	050758	959850	050352
101689	050414	106725	050308	111657	050760	959853	050353
101695	050420	106725	050309	111669	050762	959957	050355
101695	050422	106725	050310	111675	050764	959958	050332
101698	050421	106847	050412	111795	47270798	959969	050364

22 SERIES

33A/35A SERIES

55 SERIES

88 SERIES

98/99 SERIES

XP98/XP99 SERIES

94/95 SERIES

GUARD-X SERIES

ACCESSORIES / PARTS

ELECTRICAL / PARTS

	OLD P/N	NEW P/N	OLD P/N	NEW P/N	OLD P/N	NEW P/N	OLD P/N	NEW P/N
	101698	050423	106763	050311	111931	050197	959986	050333
	101701	050417	106763	050313	111932	050196	959990	090023
	101704	050419	106763	050319	111933	050189	959991	050356
	101707	050415	106763	050321	111934	050191	959995	050334
	101710	050416	106765	050312	111935	050184	960049	090030
	101713	050435	106765	050314	111936	050183	960303	970488
	101716	050436	106765	050320	111937	050198	960345	050503
	101750	050460	106765	050322	111938	050199	960548	050464
	101751	050461	106767	050315	111940	050195	101777	050455
	101752	050471	106767	050317	111941	050192	960578	050327
	101753	050472	106767	050323	111942	050193	960581	050453
	960652	050277	966384	050607	969816	050601	971267	050525
	960675	050499	966450	971614	969836	050555	971308	090038
	960756	050211	966897	050541	969837	050555	971326	050538
	960856	050260	967032	050490	969838	050556	971348	090088
	961152	050369	967116	90069	969839	050556	971351	090039
	961206	050465	967151	051705	969855	050566	971367	090047
	961218	050478	967154	051707	969864	050564	971424	050275
	961628	050453	967224	090011	969925	972466	971425	050276
	961814	050272	967448	090064	969987	050530	971483	050566
	961988	900614	967481	090097	969994	050474	971492	090040
	963011	900502	967482	050607	969995	050475	971495	090043
	963019	090035	967484	050599	970079	90048	971496	090045
	963094	090024	967489	050606	970086	050555	971507	090031
	963096	090025	967490	050609	970087	050555	971507	050585
	963098	900610	967492	050600	970088	050556	971537	090072
	963099	090002	967493	050602	970089	050556	971560	050406
	963100	050613	967495	090096	970126	970387	971561	050407
	963103	090015	967496	090090	970148	970388	971562	050570
	963128	090059	967502	050354	970173	968694	971564	050569
	963130	090032	967616	050328	970180	971556	971567	050546
	963155	090061	967622	050454	970181	971557	971568	050481
	963193	090016	967623	050454	970184	050621	971583	050611
	963512	090100	967644	050598	970193	050488	971583	PKGSRV.1010
	963531	050614	967648	050612	970194	050489	971584	090070
	963585	090010	967673	090095	970206	050554	971625	050554
	963712	900613	967736	050004	970207	050554	971627	050559
	963750	090018	967738	050004	970208	050554	971628	050560
	963757	090103	967826	090065	970368	050547	971629	050562
	963760	090098	967968	090062	970441	090074	971630	050562
	963789	090027	968503	050508	970527	050557	971631	050563
	963935	090054	968638	050486	970528	050558	971632	050563
	964041	090077	968639	050487	970547	971822	971635	050397
	964066	090107	968762	968793	970549	900588	971638	050565
	964085	090063	968833	050449	970567	050616	971781	050559
	964154	090102	968834	090056	970597	050557	971782	050560
	964358	900541	968862	050597	970598	050557	971796	050507

22 SERIES
33A/35A SERIES
55 SERIES
88 SERIES
98/99 SERIES
XP98/XP99 SERIES
94/95 SERIES
GUARD-X SERIES
ACCESSORIES / PARTS
ELECTRICAL / PARTS

OLD P/N	NEW P/N	OLD P/N	NEW P/N	OLD P/N	NEW P/N	OLD P/N	NEW P/N
964360	090034	968863	050596	970599	050557	971837	090046
964363	050509	968868	050619	970601	050558	971838	090044
964390	090037	968957	090057	970602	050558	971910	050524
964395		968964	090058	970603	050558	971974	050526
964557	090073	968969	090067	970719	090036	971993	090049
965278	050360	969199	050361	970771	090068	971493	090041
965279	050359	969219	050603	970815	050576	971494	090042
965294	090033	969235	050542	970817	050358	990592	050540
965300	050362	969244	050543	970863	972549	990598	050539
965301	050363	969252	090071	970873	970872	990598	050539
965322	090009	969295	971010	970909	050500		
965325	050273	969297	090075	970911	050559		
965326	050274	969300	661481	970912	050559		
965335	090017	969369	050477	970914	050560		
965506	050505	969467	090079	970915	050560		
965676	090021	969855	050566	971050	090066		
965916	090092	969864	050564	971052	050562		
965917	090091	969506	050566	971053	050562		
965996	050331	111939	050194	971055	050563		
106767	050325	969520	050529	960577	050279		
966165	050370	969582	090076	971056	050563		

III
 22 SERIES
 33A/35A SERIES
 55 SERIES
 88 SERIES
 98/99 SERIES
 XP98/XP99 SERIES
 94/95 SERIES
 GUARD-X SERIES
 ACCESSORIES / PARTS
 ELECTRICAL / PARTS

A library of common wiring diagrams are available at no-charge for use in single and double door applications utilizing various configurations of Allegion door hardware products. These diagrams and much more can be accessed through our Knowledge Center tool at <http://kc.allegion.com/>, simply click on the link Common wiring diagrams.

CUSTOM WIRING DIAGRAMS

When common wiring diagrams do not meet the needs of the job requirements, Allegion offers a service to purchase custom wiring diagrams. All custom wiring diagrams include a point-to-point drawing, a riser diagram, and a detailed theory of operation. Custom wiring diagrams fall into two categories; Standard and Complex.

- **Standard drawings:** All Allegion products with a single opening and a basic theory of operation. These drawings will be quoted a NET \$300.00 for each drawing.
- **Complex drawings:** Generic contacts, 3rd party components, complex relay logic, timer circuit logic, any other additional advanced logic. For United States, drawings that fall under this type will receive a NET quote depending on the time required to complete the drawings at an hourly rate of \$300.00/hour with a \$300.00 minimum NET.

How to Request a Quote for a Custom Wiring Diagram

- Custom wiring diagrams can only be ordered by and shipped to current Allegion Channel Partners.
- For United States, Wiring Diagram Request Forms can be obtained by:
 - Sending an email request to Wiring.Diagram.Request@allegion.com
 - Using the online Distributor Portal under: My Support/Orders & Invoicing
 - Using the form located on page 203
- For Canada, Wiring Diagram Request Forms can be obtained by:
 - Sending an email request to Canada.TechServices@allegion.com
 - Using the form located on page 204
- For United States, email the completed request form to Wiring.Diagram.Request@allegion.com. For Canada, please email the completed request form to Canada.TechServices@allegion.com.
- Be sure and include the following information to prevent delays to the request:
 - All supporting documentation for non-Allegion products
 - Hardware list with complete part numbers
 - Detailed Theory of operation for all openings
- Upon receipt the custom wiring coordinator will review and clarify the request as needed.
- Once all clarifications are resolved a QUOTE#, NET pricing, and lead time will be assigned and communicated to the requestor within one business day.
- QUOTE# is valid for 90 days.
- A purchase order with the QUOTE# must be received for the wiring diagrams to be produced.
 - For United States, send the completed PO to Wiring.Diagram.Request@allegion.com
 - For Canada, send the completed PO to Canada.TechServices@allegion.com
- Lead time is generally 2-3 weeks from time PO is received, more complex requests will have longer lead times.
- Changes to the original request after a quote approval may incur additional charges and affect lead time.
- Completed custom wiring diagrams will be emailed to the requestor.



United States Wiring Diagram Request Form

Must be a Schlage Electronics, Falcon, LCN, or Von Duprin Dealer

UNITED STATES ELECTRICAL DRAWING REQUEST FORM

Date:	Project Name:
Dealer/Distributor:	
Account Number:	Dealer/Distributor Contact Name:
Phone:	

Provide a Primary Technical Contact:	Phone:
--------------------------------------	--------

Provide/Attach the Following:

- All supporting documentation for all non-Allegion products
- Included hardware list with complete part numbers
- Detailed Theory of Operation for all openings

Additional information that helps expedite the project:

Door Number:
Door Size (Optional):
Door Material (Optional):
Fire Rated Opening (Optional):
Single/Pair:
Double Egress:
Interior/Exterior:
Interlocked Opening:
Basic Floor Plan/Traffic Flow (Optional):

United States
 Email completed form and supporting documentation to:
Wiring.Diagram.Request@allegion.com



Canada Wiring Diagram Request Form

CANADA ELECTRICAL DRAWING REQUEST FORM

Rep./Distributor Name:

Job Name:

Contact Name:

Phone:

Fax:

P.O.#

Date:

Select Drawing Type

Riser:

Point to Point:

Both:

Door Type:

Door Number:

Fire Rated Opening:

Double Egress:

Single:

Pair:

Specify all electrical hardware:

Quantity:

Power Supply:

Maglock/Elec. Strike:

Card Reader/Keypad:

Controller/Console:

Keyswitch:

Push Button:

Auto Operator:

Actuator:

Closer/Holder:

Exit Device:

Power Transfer:

Door Contact:

Other:

Specify daytime operation:

Push Side:

Pull Side:

Specify nighttime operation:

Push Side:

Pull Side:

Provide a sketch of the door opening if positioning of hardware is pertinent:

Canada

Email completed form and supporting documentation to:
Canada.TechServices@allegion.com



Allegion's collaboration platform for the life-cycle of the opening

Capture, maintain, and collaborate on door hardware requirements for BIM and non-BIM projects.

Track and review changes to openings and hardware selections.

Select an opening and view the plans, hardware sets, and product information.

© 2021 Allegion 013845

Making doors the easiest part of the building

Allegion's Overtur™ is the digital environment connecting all building phases in opening design, construction and ongoing management.

Learn more at discover-overtur.allegion.com or contact your Regional Sales Office.

KRYPTONITE ■ LCN ■  ■ STEELCRAFT ■ VON DUPRIN



III
22 SERIES
33A/35A SERIES
55 SERIES
88 SERIES
98/99 SERIES
XP98/XP99 SERIES
94/95 SERIES
GUARD-X SERIES
ACCESSORIES / PARTS
ELECTRICAL / PARTS

About Allegion

Allegion (NYSE: ALLE) is a global pioneer in seamless access. We keep people and their assets safe, wherever they are, bringing together simple solutions, convenient access and advanced technology.

For more, visit www.allegion.com

KRYPTONITE ■ LCN ■  ■ STEELCRAFT ■ VON DUPRIN