

# Price List 2023

## RCI Electronic Controls

United States | March 2023



# What's New

This price book dated March 2023 contains new PRICE CHANGES.  
All price changes affect the products listed below and take effect March 6, 2023.

## RCI Electronic Access Controls

After careful consideration, we are announcing the following changes for the US and Canada markets:

- .7% average increase across our mechanical products BEST, dormakaba & design hardware;
- .75% Best Locks; 9.5% BEST Electronics
- .9% average increase across our electronic products (BEST, dormakaba)
- .5% increase for Keyscan and RCI products



# Table of Contents

<b>What's New</b>		5	
<b>Electromagnetic Locks</b>	8310 MultiMag®	7	
	8320 MultiMag®	7	
	8310-IQ IntelliMag®	8	
	8320-IQ IntelliMag®	8	
	DE8310 Delayed Egress	9	
	171HD Magnetic Lock	10	
	8360 Mortise MiniMag®	10	
	8365 Mortise MicroMag®	11	
	8371 Surface MiniMag®	12	
	8372 Surface MiniMag®	12	
	8375 Surface MicroMag®	13	
	8380 GateMag®	13	
	Accessories	14-16	
	Building Code Signs	17	
<b>Electric Strikes</b>	0161 3/4" Semi-Mortise Rim Strikes	19	
	0162 3/4" Surface Mount Rim Strikes	19	
	0163 1/2" Surface Mount Rim Strikes	20	
	F1114 Centerline Strikes	21	
	F1119 Centerline Strikes	21	
	F2164/2364 All-In-One Strikes	22	
	4 Series Centerline Strikes	23	
	6 Series Centerline Strikes	24	
	7 Series Centerline Strikes	25	
	12C Compact Strike	26	
	VR165 Vertical Rod Strike	26	
	VR166 Vertical Rod Strike	26	
	Modular Strike Inserts	27	
	Modular Strike Faceplates	28	
	Accessories	29-30	
	<b>Keypads &amp; Readers</b>	RCI 125 kHz Readers	32
		RCI 125 kHz Credentials	33
RCI 13.56 MHz Readers		34	
RCI 13.56 MHz Credentials		35	
RCI Receivers & Transmitters		36	
9212 Keypads		37	
9320 / 9321 Reader + Controller		38	
9322 Reader + Controller		39	

	9323 Reader + Controller	39
<b>Switches</b>	906 Handicap Pushbutton	41
	908 Exit Pushbutton	41
	916 Tamper-Resistant Handicap Pushbutton	42
	918 Tamper-Resistant Exit Pushbutton	42
	990 Oversized Tamper-Resistant Pushbutton	43
	991 Pneumatic Time Delay Pushbutton	44
	919 Rotary Release Pushbutton	45
	920 Emergency Release Keyswitch/Pushbutton	45
	917 Easy Touch Pushbutton	46
	972 All-In-One Illuminated Pushbutton	46
	970 Illuminated Exit Pushbutton	47
	975 Illuminated Exit Pushbutton	47
	980 Economy Pushbutton	48
	903 Audible Alert	48
	960 Tamper-Resistant Keyswitch	49
	904P Emergency Pull Station	50
	913 Microwave Motion Switch	50
	909 Rocker Switch	50
	914 Sounder	50
	915 Passive Infrared	51
	915AFI Active Focused Infrared	51
	IL06 Barrier-Free Controller	51
	946 Square Push Plate	52
	950 Round Push Plate	52
	946T Square Short-Range Touchless Actuator	53
	950T Round Short-Range Touchless Actuator	53
	Touch toTouchless Conversion Module	54
	910TC Touchless Switch	55
	912 Series Battery powered touch-free actuators	56
	940 Rectangular Push Plate	57
	941 Mullion Push Plate	57
	9LP36 Low Profile Push Plate	58
	9RCT433 Transmitters	58
	9DRCR433 Receivers	58
Accessories	59	
9500/9501 Mortise Pin Transfers	60	
9507/9509 Flex Loops	60	
9520 Series Electrified Hinges	60	
9512/9513 Bridge Cables	61	
9530 Balanced Magnetic Contact DPS	61	

	9540 Recessed Magnetic Contact DPS	61
<b>Locksets</b>	C800 Series Cylindrical Locksets	63-64
<b>Specialty Locks</b>	YG80 Electronic heavy-duty door lock	66
	3590 Lock 'N' Prox	67
	3510LM Electromechanical Cabinet Lock	68
	3513 Electromechanical Cabinet Lock	68
	3525 Electromechanical Rack Handle Lock	69
	MEM4400 Compact Electromechanical Lock	70
	S2500A Mini Electromagnetic Lock	70
	EM-MAG1500 Compact Electromechanical Lock	70
	MEM2400 Compact Electromechanical Lock	70
<b>Power Supplies</b>	DKPS-2A Power Supply	73
	DKPS-4A Power Supply	73
	DKPS-6A Power Supply	73
	WPDT Wireless power & data transfer	74
	Accessories	75
<b>Door Controllers and Peripherals</b>	Keyscan LUNA™ SDACSKT - SDAC Smart Kit	78
	K-SMART3 13.56MHz BLE Reader	78
	K-SECURE 1K Ten Pack ISO Smartcard	79
	K-SECURE 1K ISO Contactless Secure Smartcard	79
	K-SF-1K Smart Fob	80
	Keyscan LUNA™ SDAC Replacement Antenna	81
	PS1225 Transformer	81
<b>Exit Devices</b>	120 Series Exit Bar	84
	1200 Series Mechanical Rim Exit Bar	85
	1300 Series Electrified Rim Exit Bar	85
	Exterior Trims	88
<b>Terms and Conditions of Sale</b>		89

# Touchless Access Solutions

Good for Hygiene. Good for You.



**Touchless switches**



**Touchless actuators**



**Low energy swing door operators**

## Reduce the spread of germs in your facility.

Hygiene is one of the most important things in our lives. Touchless door activation can make the difference when it comes to a clean, hygienic facility. Touchless access is crucial in high contact public places such as healthcare facilities, restaurants, schools, offices and restrooms.

With touchless access, abuse-related replacement expenses are greatly reduced. All switches come with a warranty. dormakaba access solutions offers many solutions to fit your needs for a touchless solution including touchless switches and low energy swing door operators. Minimizing high touchpoints does not mean you will compromise your facility's safety, security or health.

# Electromagnetic Locks





# RCI Electromagnetic Locks



## 8310 MultiMag®

For single outswinging interior or perimeter doors.  
 10-1/2"W x 2-7/8"H x 1-5/8"D (268mm x 73mm x 41mm) –  
 Includes 1/4" (6mm) mounting bracket  
 Armature Plate: 7-7/16"W x 2-3/8"H x 5/8"D  
 (190mm x 61mm x 16mm)



## 8320 MultiMag®

For double outswinging interior or perimeter doors.  
 21-1/8"W x 2-7/8"H x 1-5/8"D (536mm x 73mm x 41mm) –  
 Includes 1/4" (6mm) mounting bracket  
 Armature Plate: 7-7/16"W x 2-3/8"H x 5/8"D  
 (190mm x 61mm x 16mm) each

8310 MultiMag® - for Single Outswinging Doors		List Price
8310 x 28	Single Mag 12/24VDC x 28	\$632.00
8310 DSS x 28	Single Mag DSS 12/24VDC x 28	\$740.00
8310 SCS x 28	Single Mag SCS 12/24VDC x 28	\$770.00
8310 DSS/SCS x 28	Single Mag DSS/SCS 12/24VDC x 28	\$859.00
40 finish	Add	\$51.00

8320 MultiMag® - for Double Outswinging Doors		List Price
8320 x 28	Double Mag 12/24VDC x 28	\$1,258.00
8320 DSS x 28	Double Mag 2DSS 12/24VDC x 28	\$1,474.00
8320 SCS x 28	Double Mag 2SCS 12/24VDC x 28	\$1,535.00
8320 DSS/SCS x 28	Double Mag 2DSS/SCS 12/24VDC x 28	\$1,719.00
40 finish	Add	\$65.00

### How To Order

MultiMag®		Finish	
Single Magnet	10	28	-Brushed Anodized Aluminum <sup>2</sup>
Double Magnet	20	40	-Brushed Anodized Dark Bronze
83		x	
	SCS		-Security Condition Sensor
	DSS		-Door Status Sensor
	DSS/SCS		-Door Status Sensor and Security Condition Sensor

#### Options

Example: **8310 SCS x 28**

<sup>2</sup>Standard

# RCI Electromagnetic Locks



## 8310-IQ IntelliMag®

For single outswinging interior or perimeter doors.  
 10-1/2"W x 2-7/8"H x 1-5/8"D (268mm x 73mm x 41mm) –  
 Includes 1/4" (6mm) mounting bracket  
 Armature Plate: 7-7/16"W x 2-3/8"H x 5/8"D  
 (190mm x 61mm x 16mm)



## 8320-IQ IntelliMag®

For double outswinging interior or perimeter doors.  
 21-1/8"W x 2-7/8"H x 1-5/8"D (536mm x 73mm x 41mm) –  
 Includes 1/4" (6mm) mounting bracket  
 Armature Plate: 7-7/16"W x 2-3/8"H x 5/8"D  
 (190mm x 61mm x 16mm) each

8310 IntelliMag® - for Single Outswinging Interior or Perimeter Doors		List Price
8310-IQ x 28	8310IQ LSS x Time Delay x 28	\$908.00
40 finish	Add	\$51.00

8320 IntelliMag® - for Double Outswinging Interior or Perimeter Doors		List Price
8320-IQ x 28	8320IQ LSS x Time Delay x 28	\$1,812.00
40 finish	Add	\$65.00

### How To Order

		<b>IntelliMag®</b>			
10	-Single Magnet				
20	-Double Magnet				
83	-IQ	x			
			28	-Brushed Anodized Aluminum <sup>2</sup>	
			40	-Brushed Anodized Dark Bronze	
				<b>Finish</b>	

Example: **8320-IQ x 40**  
<sup>2</sup>Standard

# RCI Electromagnetic Locks



\*Shown: DE8310S

## DE8310 Delayed Egress

For single outswinging perimeter door.

DE8310: 10-13/16"W x 2-7/8"H x 2-1/8"D (275mm x 73mm x 54mm) –

Includes 1/4" (6mm) mounting bracket

DE8310S: 11-3/4"W x 2-7/8"H x 2-1/8"D (299mm x 73mm x 54mm) –

Includes 1/4" (6mm) mounting bracket

Armature Plate: 7-7/16"W x 2-3/8"H x 5/8"D (190mm x 61mm x 16mm)

Delayed Egress Electromagnetic Lock - for Single Outswinging Perimeter Door		List Price
DE8310 x 28	Delayed Egress with External Sounder	\$1,535.00
DE8310S x 28	Delayed Egress with Built-in Sounder	\$1,764.00

### How To Order

DE8310  x  28  
 S – Built-In Sounder  
**Options**

Example: **DE8310 S x 28**

# RCI Electromagnetic Locks



## 171HD Magnetic Lock for Hazardous Locations

14"W x 1-3/4"H x 2"D (355mm x 45mm x 51mm)  
 Armature Plate: 10-3/4"W x 1-3/4"H x 5-8"D (273mm x 45mm x 16mm)

171HD Magnetic Lock for Hazardous Locations		List Price
171HD	For single out-swinging doors, push side mount.	\$2,564.00
ZB171HD	For single in-swinging doors, pull side mount. Includes "Z" bracket inswing assembly kit.	\$2,740.00



## 8360 Mortise MiniMag®

For sliding doors.  
 9"W x 1-1/2"H x 1-1/6"D (229mm x 38mm x 27mm) –  
 Includes 3/4" (19mm) mounting tabs  
 Armature Plate: 7-1/4"W x 1-1/2"H x 1/2"D  
 (185mm x 38mm x 13mm)

Mortise MiniMag® - for Single Doors		List Price
8360 x 28	Mortise MiniMag® 12/24VDC x 28	\$525.00

### How To Order

8360 x 28

# RCI Electromagnetic Locks



## 8365 Mortise MicroMag®

For small enclosures.

7-15/16"W x 1-11/32"H x 13/16"D (202mm x 34mm x 21mm) – Includes 11/16" (17.5mm) mounting tabs

Armature Plate: 5-1/8"W x 1-1/4"H x 21/64"D  
(130mm x 32mm x 8.5mm)

Mortise MicroMag® - for Small Enclosures		List Price
8365 x 28	Mortise MiniMag® 12/24VDC x 28	\$387.00

### How To Order

8365 x 28

# RCI Electromagnetic Locks



## 8371 Surface MiniMag®

For single outswinging interior or perimeter doors.  
 9-3/8"W x 1-7/8"H x 1"D (238mm x 48mm x 25mm) –  
 Includes 3/16" (5mm) mounting bracket  
 Armature Plate: 7-1/4"W x 1-1/2"H x 1/2"D  
 (185mm x 38mm x 13mm)

## 8372 Surface MiniMag®

For double outswinging interior or perimeter doors without mullions.  
 18-3/4"W x 1-7/8"H x 1"D (476mm x 48mm x 25mm) –  
 Includes 3/16" (5mm) mounting bracket  
 Armature Plate: 7-1/4"W x 1-1/2"H x 1/2"D  
 (185mm x 38mm x 13mm) each

Surface MiniMag® - for Single Outswinging Interior Doors		List Price
8371 x 28	Single MiniMag® 12/24VDC x 28	\$471.00
8371 SCS x 28	Single MiniMag® SCS 12/24VDC x 28	\$551.00
8371 DSS x 28	Single MiniMag® DSS 12/24VDC x 28	\$532.00
8371 DSS/SCS x 28	Single MiniMag® DSS/SCS 12/24VDC x 28	\$611.00
40 finish	Add	\$73.00

Surface MiniMag® - for Double Outswinging Interior Doors w/o Mullions		List Price
8372 x 28	Double MiniMag® 12/24VDC x 28	\$939.00
8372 SCS x 28	Double MiniMag® SCS 12/24VDC x 28	\$1,061.00
8372 DSS x 28	Double MiniMag® DSS 12/24VDC x 28	\$1,100.00
8372 DSS/SCS x 28	Double MiniMag® DSS/SCS 12/24VDC x 28	\$1,221.00
40 finish	Add	\$143.00

### How To Order

MiniMag®		Finish	
Single Magnet	71	28	–Brushed Anodized Aluminum <sup>2</sup>
Double Magnet	72	40	–Brushed Anodized Dark Bronze
	83	x	
	SCS		–Security Condition Sensor
	DSS		–Door Status Sensor
	DSS/SCS		–Door Status Sensor And Security Condition Sensor

#### Options

Example: **8371 SCS x 28**

<sup>2</sup>Standard

# RCI Electromagnetic Locks



## 8375 Surface MicroMag®

For swinging doors on small enclosures.  
 6-17/32"W x 1-1/2"H x 13/16"D (166mm x 38mm x 21mm) –  
 Includes 1/8" (3mm) mounting bracket  
 Armature Plate: 5-1/8"W x 1-1/4"H x 21/64"D  
 (130mm x 32mm x 8.5mm)

## 8380 GateMag®

For interior or exterior perimeter gates.  
 8-7/8"W x 2-1/2"H x 1-3/4"D (225mm x 63mm x 45mm)  
 Armature Plate: 7-7/16"W x 2-3/8"H x 5/8"D (190mm x 61mm x 16mm)

Surface MicroMag® - for Swingong Doors on Small Enclosures		List Price
8375 x 28	Surface MicroMag® 12/24VDC x 28	\$333.00

GateMag®		List Price
8380 x 32D	GateMag® x RLS x 32D	\$645.00

### How To Order

8375 x 28

### How To Order

8380 x 32D

# RCI Electromagnetic Locks Accessories



## Angle Brackets

For narrow aluminum frames or center-hung single-acting doors, when inadequate space is left for mounting.

- Available in Brushed Anodized Aluminum (28) or Brushed Anodized Dark Bronze (40). Please specify when ordering.

Model	Dimensions	Finish	Compatible with	List Price
AB-01	1"H x 1"W x 10-1/2"L	28/40	8310	\$57.00
AB-02	1-1/2"H x 1"W x 10-1/2"L	28/40	8310	\$62.00
AB-03	1-1/2"H x 1-1/4"W x 10-1/2"L	28/40	8310	\$65.00
AB-20	1"H x 1"W x 21"L	28/40	8320	\$93.00
AB-21	1-1/2"H x 1"W x 21"L	28/40	8320	\$96.00
AB-22	1-1/2"H x 1-1/4"W x 21"L	28/40	8320	\$98.00
AB-710	1"H x 1"W x 9-3/8"L	28/40	8371	\$57.00
AB-711	1-1/2"H x 1"W x 9-3/8"L	28/40	8371	\$62.00
AB-712	1-1/2"H x 1-1/2"W x 9-3/8"L	28/40	8371	\$65.00
AB-713	1-1/2"H x 2"W x 9-3/8"L	28/40	8371	\$68.00
AB-720	1"H x 1"W x 18-3/4"L	28/40	8372	\$93.00
AB-721	1-1/2"H x 1"W x 18-3/4"L	28/40	8372	\$96.00
AB-722	1-1/2"H x 1-1/2"W x 18-3/4"L	28/40	8372	\$98.00
AB-723	1-1/2"H x 2"W x 18-3/4"L	28/40	8372	\$101.00
AB179NR-258	1-1/2"H x 2-5/8"W x 14"L For door with No Reveal - Single - Angle Bracket	28	171HD	\$330.00
AB179R-118-158	1"H x 1"W x 14"L For 1-1/8" to 1-5/8" Reveal - Single - Angle Bracket	28	171HD	\$157.00
AB179R-58-1	1-1/2"H x 2"W x 14"L For 5/8" to 1" Reveal - Single - Angle Bracket	28	171HD	\$207.00



## Armature Bolts

Model	Dimensions	Description	List Price
<b>Compatible with: 8310, 8310-IQ, DE8310, EW8310, 8371, 8380</b>			
ARMB155	2-1/8" (55mm)	For doors 1-3/4"-2-1/4" (44-57mm) thick	\$10.20
ARMB170	2-3/4" (70mm)	For doors 2-1/4"-2-3/4" (57-70mm) thick	\$10.20
ARMB180	3-1/8" (80mm)	For doors 2-1/2"-3" (70-76mm) thick	\$10.20
<b>Compatible with: 8320, 8320-IQ, 8372</b>			
ARMB255	2-1/8" (55mm)	For doors 1-3/4"-2-1/4" (44-57mm) thick	\$18.00
ARMB270	2-3/4" (70mm)	For doors 2-1/4"-2-3/4" (57-70mm) thick	\$18.00
ARMB280	3-1/8" (80mm)	For doors 2-1/2"-3" (70-76mm) thick	\$18.00



## Armature Plates

Model	Dimensions	Finish	Compatible with	List Price
AP01	3/8" (9.5mm)	Steel	8310, 8320, 8380	\$80.00
AP02	5/8" (16mm)	Steel	8310, 8320, 8380	\$80.00
AP03	3/8" (9.5mm)	Steel	8360, 8371, 8372	\$80.00
AP04	5/16" (8mm)	Steel	8365, 8375	\$72.00
AP20	3/8" (9.5mm)	Steel	8310xDSS, 8320xDSS	\$124.00
AP21	5/8" (16mm)	Steel	8310xDSS, 8320xDSS	\$124.00
AP03D	3/8" (9.5mm)	Steel	8371xDSS, 8372xDSS	\$124.00



## DSS Retrofit Kits

If a door status sensor is desired after magnet has been installed, it can easily be added on site.

- Kit includes both Brushed Anodized Aluminum (28) and Brushed Anodized Dark Bronze (40) cover plate screws.

Model	Description	Finish	Compatible with	List Price
DSR01	3/8" (9.5mm)	Steel	8310	\$157.00
DSR02	5/8" (16mm) Standard	Steel	8310	\$171.00
DSR03	3/8" (9.5mm)	Steel	8320	\$309.00
DSR04	5/8" (16mm) Standard	Steel	8320	\$341.00



## Armature Plate Holders

- Available in Brushed Anodized Aluminum (28) or Brushed Anodized Dark Bronze (40). Please specify when ordering.

Model	Description	Finish	Compatible with	List Price
AH10	8310 armature plate holder	28/40	8310	\$111.00
AH15	8310xDSS armature plate holder	28/40	8310xDSS	\$45.00
AH20	8320 armature plate holder	28/40	8320	\$217.00
AH25	8320xDSS armature plate holder	28/40	8320xDSS	\$87.00
AH71	8371 armature plate holder	28/40	8371	\$111.00
AH72	8372 armature plate holder	28/40	8372	\$217.00
AH75	8375 armature plate holder	28/40	8375	\$111.00

**NOTE:** Accessories may impact holding force.



# RCI Electromagnetic Locks Accessories



## Conduit Mounting Bracket

Used anywhere surface-mounted conduit is required to run wires to the face of the magnetic lock.

Model	Dimensions	Finish	Compatible with	List Price
CMB108	1"D x 2-11/64"H x 10-9/16"L	28	8310	\$97.00



## Glass Door Brackets

Required for glass doors without mounting rails.

Model	Dimensions	Finish	Compatible with	List Price
GB8112	1/2" (13mm)	32D	8310	\$223.00
GB8134	3/4" (19mm)	32D	8310	\$223.00
GB8212	1/2" (13mm)	32D	8320	\$439.00
GB8234	3/4" (19mm)	32D	8320	\$432.00
GB7112	1/2" (13mm)	32D	8371	\$223.00
GB7134	3/4" (19mm)	32D	8371	\$223.00
GB7212	1/2" (13mm)	32D	8372	\$439.00
GB7234	3/4" (19mm)	32D	8372	\$439.00
GB7512	1/2" (13mm)	32D	8375	\$195.00
GB7534	3/4" (19mm)	32D	8375	\$195.00



## Filler Bars/Filler Plates

For frame stops narrower than 2" (51mm).

- Available in Brushed Anodized Aluminum (28) or Brushed Anodized Dark Bronze (40). Please specify when ordering.

Model	Dimensions	Finish	Compatible with	List Price
FB-01	1/4"H x 3/4"W x 10-1/2"L	28/40	8310	\$45.00
FB-02	3/8"H x 3/4"W x 10-1/2"L	28/40	8310	\$47.00
FB-03	1/2"H x 3/4"W x 10-1/2"L	28/40	8310	\$50.00
FB-04	5/8"H x 3/4"W x 10-1/2"L	28/40	8310	\$52.00
FB-05	1/2"H x 5/8"W x 10-1/2"L	28/40	8310	\$50.00
FB-20	1/4"H x 3/4"W x 21"L	28/40	8320	\$80.00
FB-21	3/8"H x 3/4"W x 21"L	28/40	8320	\$84.00
FB-22	1/2"H x 3/4"W x 21"L	28/40	8320	\$87.00
FB-23	5/8"H x 3/4"W x 21"L	28/40	8320	\$90.00
FB-24	1/2"H x 5/8"W x 21"L	28/40	8320	\$87.00
FB-710	1/4"H x 3/4"W x 9-3/8"L	28/40	8371	\$45.00
FB-711	3/8"H x 3/4"W x 9-3/8"L	28/40	8371	\$47.00
FB-712	1/2"H x 3/4"W x 9-3/8"L	28/40	8371	\$50.00
FB-713	5/8"H x 3/4"W x 9-3/8"L	28/40	8371	\$52.00
FB-720	1/4"H x 3/4"W x 18-3/4"L	28/40	8372	\$68.00
FB-721	3/8"H x 3/4"W x 18-3/4"L	28/40	8372	\$70.00
FB-722	1/2"H x 3/4"W x 18-3/4"L	28/40	8372	\$73.00
FB-723	5/8"H x 3/4"W x 18-3/4"L	28/40	8372	\$77.00
FP178-12	1/2"H x 1-1/4"W x 14"L Single Filler Plate	28	171HD	\$138.00
FP178-58	5/8"H x 1-1/4"W x 14"L Single Filler Plate	28	171HD	\$138.00



## L Brackets

Required when there is no space on the header to mount the magnetic lock.

Magnet mounts on bracket and bracket mounts on vertical face of frame.

- Available in Brushed Anodized Aluminum (28) or Brushed Anodized Dark Bronze (40). Please specify when ordering.

Model	Dimensions	Finish	Compatible with	List Price
LB-10	2-1/2"H x 2"W x 10-1/2"L	28/40	8310	\$111.00
LB-20	2-1/2"H x 2"W x 21"L	28/40	8320	\$217.00



## Post Bracket

Used to mount armature plate to sliding gate.

Model	Dimensions	Finish	Compatible with	List Price
PB-80	3-1/2"H x 2-1/2"W x 8-7/8"L	28	8380	\$113.00

# RCI Electromagnetic Locks Accessories



## Spacers

For aluminum blade stop frames. Used to lower the magnet to align with armature plate.

- Available in Brushed Anodized Aluminum (28) or Brushed Anodized Dark Bronze (40). Please specify when ordering.

Model	Dimensions	Finish	Compatible with	List Price
SP-01	1/4"H x 1-1/2"W x 10-1/2"L	28/40	8310	\$45.00
SP-02	3/8"H x 1-1/2"W x 10-1/2"L	28/40	8310	\$47.00
SP-03	1/2"H x 1-1/2"W x 10-1/2"L	28/40	8310	\$50.00
SP-04	5/8"H x 1-1/2"W x 10-1/2"L	28/40	8310	\$52.00
SP-20	1/4"H x 1-1/2"W x 21"L	28/40	8320	\$80.00
SP-21	3/8"H x 1-1/2"W x 21"L	28/40	8320	\$84.00
SP-22	1/2"H x 1-1/2"W x 21"L	28/40	8320	\$87.00
SP-23	5/8"H x 1-1/2"W x 21"L	28/40	8320	\$90.00
SP-710	1/4"H x 1"W x 9-3/8"L	28/40	8371	\$45.00
SP-711	3/8"H x 1"W x 9-3/8"L	28/40	8371	\$47.00
SP-712	1/2"H x 1"W x 9-3/8"L	28/40	8371	\$50.00
SP-713	5/8"H x 1"W x 9-3/8"L	28/40	8371	\$52.00
SP-720	1/4"H x 1"W x 18-3/4"L	28/40	8372	\$68.00
SP-721	3/8"H x 1"W x 18-3/4"L	28/40	8372	\$70.00
SP-722	1/2"H x 1"W x 18-3/4"L	28/40	8372	\$73.00
SP-723	5/8"H x 1"W x 18-3/4"L	28/40	8372	\$77.00
SP-75	1/4"H x 13/16"W x 6-9/16"L	28/40	8375	\$44.00
SPDE01	DE8310 Spacer 1/4"x2-7/8"x10-13/16"	28/40		\$45.00
SPDE02	DE8310 Spacer 3/8"x2-7/8"x10-13/16"	28/40		\$47.00
SPDE03	DE8310 Spacer 1/2"x2-7/8"x10-13/16"	28/40		\$50.00
SPDE04	DE8310 Spacer 5/8"x2-7/8"x10-13/16"	28/40		\$52.00

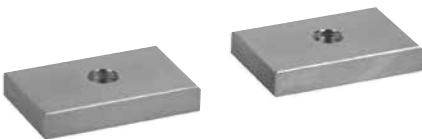

## Split Armature Plates

Allow use of single magnet lock with pair of doors.

Model	Dimensions	Finish	Compatible with	List Price
SA138	3/8" (9.5mm)	Steel	8310	\$104.00
SA158	5/8" (16mm)	Steel	8310	\$104.00
SA75	5/16" (8mm)	Steel	8375	\$90.00



## Top Jamb "Z" Bracket

Allows for horizontal adjustment of armature plate. Mounted on pull side of the door.

- Available in Brushed Anodized Aluminum (28) or Brushed Anodized Dark Bronze (40). Please specify when ordering.

Model	Description	Finish	Compatible with	List Price
TJ10	8310 Z bracket kit	28/40	8310	\$195.00
TJ20	8320 Z bracket kit	28/40	8320	\$387.00
TJ71	8371 Z bracket kit	28/40	8371	\$195.00
TJ72	8372 Z bracket kit	28/40	8372	\$387.00
TJ75	8375 Z bracket kit	28/40	8375	\$141.00
TJ80	8380 Z bracket kit	28/40	8380	\$153.00
TJDE108	DE8310 bracket kit For inswing applications.	28	DE8310	\$319.00



## Hardware Packs

Model	Description	Compatible with	List Price
HK8310	Includes: Allen wrench, metal sleeve, armature bolt, sexnut, bolt, steel washers, rubber washers, flat head screws, pan head screws, plugs, TEK screws.	8310, 8320 (Buy 2 to make one 8320 Hardware kit)	\$27.00
HK8371	Includes: Allen wrench, metal sleeve, armature bolt, sexnut, bolt, steel washers, rubber washers, flat head screws, pan head screws, plugs, TEK screws.	8371	\$27.00
HK8375	Includes Allen wrench, armature bolt, steel washers, rubber washers, TEK8375 screws, round head screws, button head sexnut.		\$27.00
HK83809	8380 Hardware Pack		\$27.00
HK83608	8360 Hardware Pack		\$27.00
HK83658	8365 Hardware Pack		\$27.00

# RCI Electromagnetic Locks Building Code Signs



## BC1 Series Building Code Signs

11"W x 10"H (28cm x 25cm)

• Available in English, French and Spanish. Please specify when ordering.

Model	Description	List Price
BC1P	15 Seconds, printed on clear Plexiglass	\$83.00
BC1M	15 Seconds, printed on clear Mylar	\$52.00
BC1MW	15 Seconds, printed on white Mylar	\$52.00
BC1T	15 Seconds, red vinyl transfer letters	\$69.00
BC1M-30	30 Seconds, printed on clear Mylar	\$69.00



## BCDE Series Building Code Signs

11"W x 10"H (28cm x 25cm)

• Available in English, French and Spanish. Please specify when ordering.

Model	Description	List Price
BCDEP	15 Seconds, printed on clear Plexiglass	\$90.00
BCDEM	15 Seconds, printed on clear Mylar	\$90.00
BCDEMW	15 Seconds, printed on white Mylar	\$90.00
BCDET	15 Seconds, red vinyl transfer letters	\$90.00
BCDEM-30	30 Seconds, printed on clear Mylar	\$90.00



## BC2 Series Building Code Signs

13"W x 4"H (33cm x 10cm)

• Available in English, French and Spanish. Please specify when ordering.

Model	Description	List Price
BC2P	Printed on clear Plexiglass	\$69.00
BC2M	Printed on clear Mylar	\$19.00
BC2MW	Printed on white Mylar	\$19.00
BC2T	Red vinyl transfer letters	\$41.00

Sign size may increase slightly for French or Spanish text.



## BC3 Series Building Code Signs

14"W x 12"H (36cm x 30.5cm)

• Available in English, French and Spanish. Please specify when ordering.

Model	Description	List Price
BC3P	Printed on clear Plexiglass	\$83.00
BC3M	Printed on clear Mylar	\$86.00
BC3MW	Printed on white Mylar	\$93.00
BC3T	Red vinyl transfer letters	\$69.00

# Electric Strikes



# RCI Electric Strikes



**0 Series**

## 0161 3/4" Semi-Mortise Rim Strikes

Semi-mortise rim strike designed for use with Pullman latch rim exit devices.

1-3/4"W x 9"H x 1-5/8"D (45mm x 229mm x 41mm)

0161 for Rim Exit Devices		List Price
0161-05 x 32D	0161 12VAC/DC x 32D	\$381.00
0161-08 x 32D	0161 24VAC/DC x 32D	\$381.00

**How To Order**

0161	-		x	32D
		05		-12VAC/VDC
		08		-24VAC/VDC

**Voltage**

Example: **0161 - 05 x 32D**



**0 Series**

## 0162 3/4" Rim Strikes

Completely surface-mounted rim strike designed for use with Pullman latch rim exit devices.

1-3/4"W x 9"H x 3/4"D (45mm x 229mm x 20mm)

0162 for Rim Exit Devices		List Price
0162 x 32D	0162 12 to 24VAC & 12 or 24VDC x 32D	\$623.00
0162LM x 32D	0162 12 to 24VAC & 12 or 24VDC with Latch Monitoring x 32D	\$655.00
F0162	Fire Rated 0162 12 to 24VAC & 12 or 24VDC x 32D	\$764.00
F0162LM x 32D	Fire Rated 0162 12 to 24VAC & 12 or 24VDC with Latch Monitoring x 32D	\$796.00

**How To Order**

**Options**

F	-Fire-Rated			
		0162	x	32D
			LM	-Latch Monitor

**Options**

Example: **F0162LM x 32D**

# RCI Electric Strikes



**O Series**

## 0163 1/2" Solenoid Rim Strikes

Slim, adjustable design ideal for tight-fitting installations.  
 Designed for use with Pullman latch rim exit devices.  
 1-3/4"W x 9"H x 1/2"D (45mm x 229mm x 13mm)

0163 for Rim Exit Devices		List Price
0163 x 32D	0163 1/2" Rim Strike 11-16VAC, 12VAC/VDC, or 24VAC/VDC x 32D	\$617.00
0163LM x 32D	0163 1/2" Rim Strike 11-16VAC, 12VAC/VDC, or 24VAC/VDC with Latch Monitoring x 32D	\$648.00

**How To Order**

0163  x  32D  
 LM -Latch Monitor  
 Example: **0163LM x 32D**

# RCI Electric Strikes



## F1 Series F1114 Centerline Strikes

Features stainless steel faceplate with square corners ideal for hollow metal frames.  
 Faceplate: 1-1/4"W x 4-7/8"H (32mm x 124mm)  
 Insert Depth: 1-3/4" (45mm)

F1114 for ANSI Centerline Latch Entry (3/4" Latch Projection)		List Price
F1114-01 x 32D	Fail Locked, Fire Labeled 11-16VAC x 32D	\$577.00
F1114-05 x 32D	Fail Locked, Fire Labeled 12VAC/DC x 32D	\$577.00
F1114-08 x 32D	Fail Locked, Fire Labeled 24VAC/DC x 32D	\$577.00



## F1 Series F1119 Centerline Strikes

Features stainless steel faceplate with square corners ideal for aluminum and wood frames.  
 Faceplate: 1-3/8"W x 9"H (34mm x 229mm)  
 Insert Depth: 1-3/4"D (45mm)

F1119 for ANSI Centerline Latch Entry (3/4" Latch Projection)		List Price
F1119-01 x 32D	Fail Locked, Fire Labeled 11-16VAC x 32D	\$651.00
F1119-05 x 32D	Fail Locked, Fire Labeled 12VAC/DC x 32D	\$651.00
F1119-08 x 32D	Fail Locked, Fire Labeled 24VAC/DC x 32D	\$651.00

### How To Order

Faceplate	
14	-1-1/4"W x 4-7/8"H (32mm x 124mm), ANSI Square Corner
19	-1-3/8"W x 9"H (34mm x 229mm), Square Corner

F1	1	-	x	32D
		01		-11-16VAC
		05		-12VAC/ VDC
		08		-24VAC/ VDC

**Voltage**

Example: **F1119-01 x 32D**

# RCI Electric Strikes



**2 Series**

**F2164/2364**

**All-In-One Strikes**

Versatile design features adjustable deadbolt keeper and deadlatch ramp allowing it to work with most locks.

Faceplate: 1-1/4"W x 4-7/8"H (32mm x 124mm)

Insert Depth: 1-3/4"D (45mm)

<b>F2 Series - For Fire Rated Offset And Centerline Mortise Latch Entry</b>		<b>List Price</b>
F2164 x 32D	Fail Locked, Fire Labeled 12 to 24VAC & 12 or 24VDC x 32D	\$719.00

<b>2 Series - Offset &amp; Centerline Mortise Latch Entry</b>		<b>List Price</b>
2364 x 32D	Fail Unlocked, 12 or 24VDC x 32D	\$719.00

<b>2 Series Electric Strikes - Accessories</b>		<b>List Price</b>
F2-19 x 32D	9" 1-3/8" x 9" Center Faceplate for the F2164 & 2364 Electric Strikes – Faceplate Screws Included	\$47.00
F2-29 x 2D	9" 1-3/8" x 9" Offset Faceplate for the F2164 & 2364 Electric Strikes – Faceplate Screws Included	\$47.00

**How To Order**

**Options**

F	-Fire-Rated <sup>4</sup>			
	2	64	x	32D
		1		-Fail-Secure
		3		-Fail-Safe

**Mode**

Example: **F2164 x 32D**

<sup>4</sup>Available in fail-secure mode only.



# RCI Electric Strikes

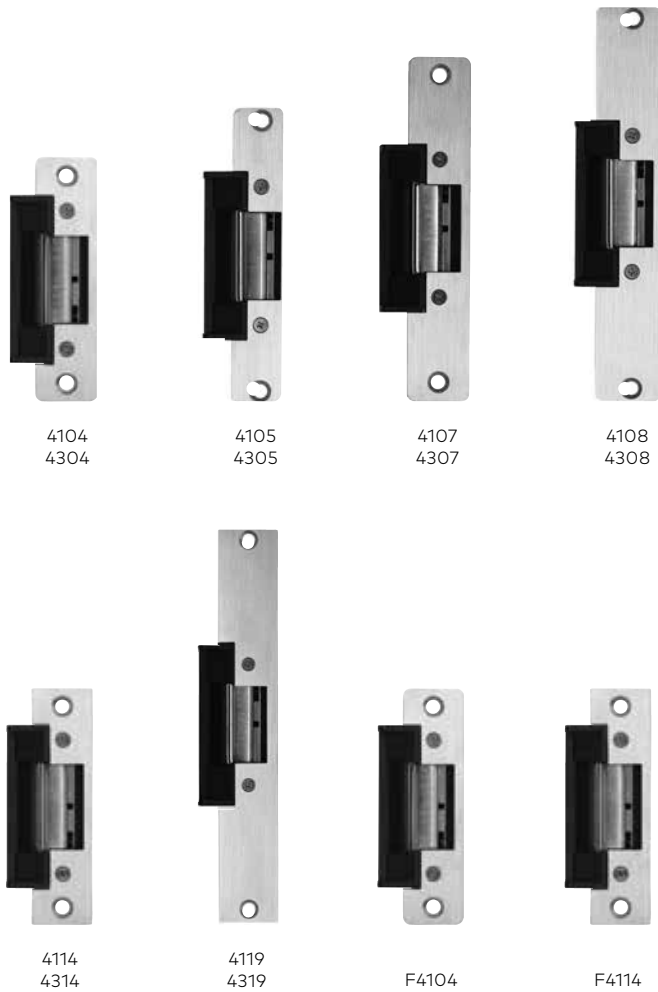

## 4 Series

### Centerline Strikes

Accommodates 3/4" (19mm) latch projection. Various faceplate options available to accommodate most frame types. Insert Depth: 1-1/2"D (38mm)

4 Series - 4104 & 4304 for ANSI Centerline Latch Entry (3/4" Latch Projection)			List Price
4104-01 x 32D	4104 11-16VAC Fail Locked x 32D		\$201.00
4104-05 x 32D	4104 12VAC/DC Fail Locked x 32D		\$201.00
4104-08 x 32D	4104 24VAC/DC Fail Locked x 32D		\$201.00
4304-06 x 32D	4304 12VDC Fail Unlocked x 32D		\$218.00
4304-09 x 32D	4304 24VDC Fail Unlocked x 32D		\$218.00

4 Series - 4114 & 4314 for ANSI Centerline Latch Entry (3/4" Latch Projection)			List Price
4114-01 x 32D	4114 11-16VAC Fail Locked x 32D		\$201.00
4114-05 x 32D	4114 12VAC/DC Fail Locked x 32D		\$201.00
4114-08 x 32D	4114 24VAC/DC Fail Locked x 32D		\$201.00
4314-06 x 32D	4314 12VDC Fail Unlocked x 32D		\$218.00
4314-09 x 32D	4314 24VDC Fail Unlocked x 32D		\$218.00

4 Series - 4105 & 4305 for Centerline Latch Entry (3/4" Latch Projection)			List Price
4105-01 x 32D	4105 11-16VAC Fail Locked x 32D		\$207.00
4105-05 x 32D	4105 12VAC/DC Fail Locked x 32D		\$207.00
4105-08 x 32D	4105 24VAC/DC Fail Locked x 32D		\$207.00
4305-06 x 32D	4305 12VDC Fail Unlocked x 32D		\$225.00
4305-09 x 32D	4305 24VDC Fail Unlocked x 32D		\$225.00

4 Series - 4107 & 4307 for Centerline Latch Entry (3/4" Latch Projection)			List Price
4107-01 x 32D	4107 11-16VAC Fail Locked x 32D		\$207.00
4107-05 x 32D	4107 12VAC/DC Fail Locked x 32D		\$207.00
4107-08 x 32D	4107 24VAC/DC Fail Locked x 32D		\$207.00
4307-06 x 32D	4307 12VDC Fail Unlocked x 32D		\$225.00
4307-09 x 32D	4307 24VDC Fail Unlocked x 32D		\$225.00

4 Series - 4108 & 4308 for Centerline Latch Entry (3/4" Latch Projection)			List Price
4108-01 x 32D	4108 11-16VAC Fail Locked x 32D		\$218.00
4108-05 x 32D	4108 12VAC/DC Fail Locked x 32D		\$218.00
4108-08 x 32D	4108 24VAC/DC Fail Locked x 32D		\$218.00
4308-06 x 32D	4308 12VDC Fail Unlocked x 32D		\$233.00
4308-09 x 32D	4308 24VDC Fail Unlocked x 32D		\$233.00

4 Series - 4119 & 4319 for Centerline Latch Entry (3/4" Latch Projection)			List Price
4119-01 x 32D	4119 11-16VAC Fail Locked x 32D		\$261.00
4119-05 x 32D	4119 12VAC/DC Fail Locked x 32D		\$261.00
4119-08 x 32D	4119 24VAC/DC Fail Locked x 32D		\$261.00
4319-06 x 32D	4319 12VDC Fail Unlocked x 32D		\$278.00
4319-09 x 32D	4319 24VDC Fail Unlocked x 32D		\$278.00

F4 Series - F4104 Fire Rated ANSI Centerline Latch Entry (3/4" Latch Projection)			List Price
F4104-05 x 32D	12VAC/DC Fail Locked, Fire Labeled x 32D		\$485.00
F4104-08 x 32D	24VAC/DC Fail Locked, Fire Labeled x 32D		\$485.00

F4 Series - F4114 Fire Rated ANSI Centerline Latch Entry (3/4" Latch Projection)			List Price
F4114-05 x 32D	12VAC/DC Fail Locked, Fire Labeled x 32D		\$485.00
F4114-08 x 32D	24VAC/DC Fail Locked, Fire Labeled x 32D		\$485.00

### How To Order

Options		Voltage		Faceplate	
Fire-Rated <sup>4</sup>	F	Fail-Safe	11-16VAC-	01	x 32D
			12VAC/VDC-	05	
Fail-Secure	4	Fail-Safe	24VAC/VDC-	08	x 32D
			12VDC-	06	
Fail-Secure	1	Fail-Secure	24VDC	09	x 32D
			1	04	
Fail-Safe	3	Fail-Safe	-1-1/4"W x 4-7/8"H (32mm x 124mm), ANSI Radius Corner		x 32D
			3	05	
Fail-Safe	7	Fail-Safe	-1-1/8"W x 5-7/8"H (29mm x 150mm), Radius Corner		x 32D
			7	07	
Fail-Safe	8	Fail-Safe	-1-1/4"W x 6-7/8"H (32mm x 175mm), Radius Corner		x 32D
			8	08	
Fail-Safe	14	Fail-Safe	-1-7/16"W x 7-15/16"H (37mm x 202mm), Radius Corner		x 32D
			14	14	
Fail-Safe	19	Fail-Safe	-1-1/4"W x 4-7/8"H (32mm x 124mm), ANSI Square Corners		x 32D
			19	19	
		Faceplate			

Example: **F4104-05 x 32D**

# RCI Electric Strikes

## 6 Series

### Centerline Strikes

Two profiles available to accommodate different latch projections.  
 Various faceplate options available to accommodate most frame types.  
 Standard Insert Depth: 1-3/16" D (30mm)  
 Low Profile Insert Depth: 1-1/16" (27mm)

6 Series - Universal - Includes 3 Faceplates		List Price
S65U x 32D	Field Selectable, 12 to 24 VAC & 12 or 24VDC x 32D	\$238.00
S65ULMKM x 32D	Field Selectable, 12 to 24 VAC & 12 or 24VDC x 32D	\$291.00
L65U x 32D	Field Selectable, 12 to 24 VAC & 12 or 24VDC x 32D	\$238.00
L65ULMKM x 32D	Field Selectable, 12 to 24 VAC & 12 or 24VDC x 32D	\$291.00

6 Series - S6504 & L6504 for ANSI Round Corner Centerline Latch Projection		List Price
S6504 x 32D	Field Selectable 12 to 24 VAC & 12 or 24VDC x 32D	\$205.00
S6504LMKM x 32D	Field Selectable 12 to 24 VAC & 12 or 24VDC x 32D	\$263.00
L6504 x 32D	Field Selectable 12 to 24 VAC & 12 or 24VDC x 32D	\$205.00
L6504LMKM x 32D	Field Selectable 12 to 24 VAC & 12 or 24VDC x 32D	\$263.00

6 Series - S6514 & L6514 for ANSI Square Corner Centerline Latch Projection		List Price
S6514 x 32D	Field Selectable 12 to 24 VAC & 12 or 24VDC x 32D	\$205.00
S6514LMKM x 32D	Field Selectable 12 to 24 VAC & 12 or 24VDC x 32D	\$263.00
L6514 x 32D	Field Selectable 12 to 24 VAC & 12 or 24VDC x 32D	\$205.00
L6514LMKM x 32D	Field Selectable 12 to 24 VAC & 12 or 24VDC x 32D	\$263.00

6 Series - S6505 & L6505 for Centerline Latch Projection		List Price
S6505 x 32D	Field Selectable 12 to 24 VAC & 12 or 24VDC x 32D	\$212.00
S6505LMKM x 32D	Field Selectable 12 to 24 VAC & 12 or 24VDC x 32D	\$268.00
L6505 x 32D	Field Selectable 12 to 24 VAC & 12 or 24VDC x 32D	\$212.00
L6505LMKM x 32D	Field Selectable 12 to 24 VAC & 12 or 24VDC x 32D	\$268.00

6 Series - S6507 & L6507 for Centerline Latch Projection		List Price
S6507 x 32D	Field Selectable 12 to 24 VAC & 12 or 24VDC x 32D	\$212.00
S6507LMKM x 32D	Field Selectable 12 to 24 VAC & 12 or 24VDC x 32D	\$268.00
L6507 x 32D	Field Selectable 12 to 24 VAC & 12 or 24VDC x 32D	\$212.00
L6507LMKM x 32D	Field Selectable 12 to 24 VAC & 12 or 24VDC x 32D	\$268.00



#### How To Order

		Options		
Latch And Keeper Monitor-		LMKM		
	65		x 32D	
Standard-	S	04		-1-1/4" W x 4-7/8" H (32mm x 124mm), ANSI Radius Corners
Low Profile-	L	05		-1-1/8" W x 5-7/8" H (29mm x 150mm), Radius Corners
		07		-1-1/4" W x 6-7/8" H (32mm x 175mm), Radius Corners
		08		-1-7/16" W x 7-15/16" (37mm x 202mm), Radius Corners
		14		-1-1/4" W x 4-7/8" H (32mm x 124mm), ANSI Square Corners
		U		-Universal, Includes 3 Faceplates (04, 08 & 14)
				<b>Faceplate</b>

Example: **L6507LMKM x 32D**

6 Series - S6508 & L6508 for Centerline Latch Projection		List Price
S6508 x 32D	Field Selectable 12 to 24 VAC & 12 or 24VDC x 3	\$220.00
S6508LMKM x 32D	Field Selectable 12 to 24 VAC & 12 or 24VDC x 32D	\$273.00
L6508 x 32D	Field Selectable 12 to 24 VAC & 12 or 24VDC x 32D	\$220.00
L6508LMKM x 32D	Field Selectable 12 to 24 VAC & 12 or 24VDC x 32D	\$273.00

# RCI Electric Strikes

## 7 Series

### Centerline Strikes

Accommodates 5/8" (16mm) latch projection. Various faceplate options available to accommodate most frame types.  
Insert Depth: 1-1/2" D (38mm)

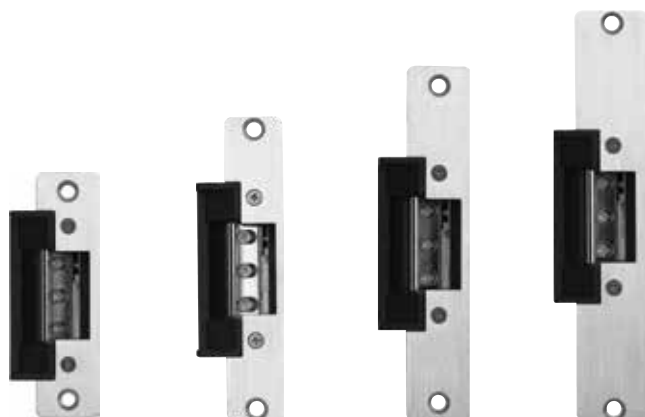

7104  
7304

7105  
7305

7107  
7307

7108  
7308



7114  
7314

7119  
7319

#### 7 Series - 7104 & 7304 for ANSI Centerline Latch Entry (5/8" Latch Projection)

		List Price
7104-01 x 32D	7104 Fail Locked 11-16VAC x 32D	\$192.00
7104-05D x 32D	7104 Fail Locked 12VDC x 32D	\$192.00
7104-07 x 32D	7104 Fail Locked 24VAC x 32D	\$192.00
7104-08D x 32D	7104 Fail Locked 24VDC x 32D	\$192.00
7304-06 x 32D	7304 Fail Unlocked 12VDC x 32D	\$203.00
7304-09 x 32D	7304 Fail Unlocked 24VDC x 32D	\$203.00

#### 7 Series - 7114 & 7314 for ANSI Centerline Latch Entry (5/8" Latch Projection)

		List Price
7114-01 x 32D	7114 Fail Locked 11-16VAC x 32D	\$192.00
7114-05D x 32D	7114 Fail Locked 12VDC x 32D	\$192.00
7114-07 x 32D	7114 Fail Locked 24VAC x 32D	\$192.00
7114-08D x 32D	7114 Fail Locked 24VDC x 32D	\$192.00
7314-06 x 32D	7314 Fail Unlocked 12VDC x 32D	\$203.00
7314-09 x 32D	7314 Fail Unlocked 24VDC x 32D	\$203.00

#### 7 Series - 7105 & 7305 for Centerline Latch Entry (5/8" Latch Projection)

		List Price
7105-01 x 32D	7105 Fail Locked 11-16VAC x 32D	\$198.00
7105-05D x 32D	7105 Fail Locked 12VDC x 32D	\$198.00
7105-07 x 32D	7105 Fail Locked 24VAC x 32D	\$198.00
7105-08D x 32D	7105 Fail Locked 24VDC x 32D	\$198.00
7305-06 x 32D	7305 Fail Unlocked 12VDC x 32D	\$208.00
7305-09 x 32D	7305 Fail Unlocked 24VDC x 32D	\$208.00

#### 7 Series - 7107 & 7307 for Centerline Latch Entry (5/8" Latch Projection)

		List Price
7107-01 x 32D	7107 Fail Locked 11-16VAC x 32D	\$198.00
7107-05D x 32D	7107 Fail Locked 12VDC x 32D	\$198.00
7107-07 x 32D	7107 Fail Locked 24VAC x 32D	\$198.00
7107-08D x 32D	7107 Fail Locked 24VDC x 32D	\$198.00
7307-06 x 32D	7307 Fail Unlocked 12VDC x 32D	\$208.00
7307-09 x 32D	7307 Fail Unlocked 24VDC x 32D	\$208.00

#### 7 Series - 7108 & 7308 for Centerline Latch Entry (5/8" Latch Projection)

		List Price
7108-01 x 32D	7108 Fail Locked 11-16VAC x 32D	\$206.00
7108-05D x 32D	7108 Fail Locked 12VDC x 32D	\$206.00
7108-07 x 32D	7108 Fail Locked 24VAC x 32D	\$206.00
7108-08D x 32D	7108 Fail Locked 24VDC x 32D	\$206.00
7308-06 x 32D	7308 Fail Unlocked 12VDC x 32D	\$219.00
7308-09 x 32D	7308 Fail Unlocked 24VDC x 32D	\$219.00

#### 7 Series - 7119 & 7319 for Centerline Latch Entry (5/8" Latch Projection)

		List Price
7119-01 x 32D	7119 Fail Locked 11-16VAC x 32D	\$252.00
7119-05D x 32D	7119 Fail Locked 12VDC x 32D	\$252.00
7119-07 x 32D	7119 Fail Locked 24VAC x 32D	\$252.00
7119-08D x 32D	7119 Fail Locked 24VDC x 32D	\$252.00
7319-06 x 32D	7319 Fail Unlocked 12VDC 32D	\$262.00
7319-09 x 32D	7319 Fail Unlocked 24VDC 32D	\$262.00

### How To Order

		Voltage		
		11-16VAC-	01	
		12VDC-	05D	
		24VAC-	07	
		24VDC-	08D	
		12VDC-	06	
		24VDC-	09	
	7		-	x 32D
Fail-Secure-	1	04	-1-1/4"W x 4-7/8"H (32mm x 124mm), ANSI radius corners	
Fail-Safe-	3	05	-1-1/8"W x 5-7/8"H (29mm x 150mm), radius corners	
Mode		07	-1-1/4"W x 6-7/8"H (32mm x 175mm), radius corners	
		08	-1-7/16"W x 7-15/16" (37mm x 202mm), radius corners	
		14	-1-1/4"W x 4-7/8"H (32mm x 124mm), ANSI square corners	
		19	-1-3/8"W x 9"H (34mm x 229mm), square corners	
			Faceplate	

Example: **7104-05D x 32D**

# RCI Electric Strikes



## 12C Compact Strike

A versatile strike suitable for all types of door frames. 1-13/16"W x 2-3/4"H x 1-1/8"D (46mm x 70mm x 28mm)

12C Compact Strike		List Price
12C x 26D	Compact electric strike	\$254.00

### How To Order

12C x 26D



## VR165 Vertical Rod Strike

Accommodates 5/8" (16mm) roller latch. Designed for use with vertical rod exit devices with roller latch.

VR165 Vertical Rod Strike		List Price
VR165	Designed for use with glass door exit devices having a roller latch	\$585.00

### How To Order

VR165 x 32D

Example: **VR165 x 32D**



## VR166 Vertical Rod Strike

Simple locking solution for surface vertical rod exit devices having a Pullman style latch.

VR166 Vertical Rod Strike		List Price
VR166	Vertical rod strike	\$414.00
VR166LMKM	Vertical rod strike with Latch & Keeper Monitor	\$458.00

### How To Order

VR166 x 32D  
LMKM – Latch and Keeper Monitor

Example: **VR166LMKM x 32D**

# RCI Electric Strikes



## 4 Series Modular Strike Inserts

Includes Lip Bracket & Hardware Pack

## 6 Series Modular Strike Inserts

Includes Lip Bracket & Hardware Pack

## 7 Series Modular Strike Inserts

Includes Lip Bracket & Hardware Pack

### How To Order

		<b>Voltage</b>	
<b>Fail-Secure</b>		11-16VAC-	01
		12VAC/VDC-	05
		24VAC/VDC-	08
<b>Fail-Safe</b>		12VDC-	06
		24VDC-	09
<b>A</b>	<b>4</b>	-	
	1	-Fail-Secure	
	3	-Fail-Safe	
		<b>Mode</b>	
Example: <b>A41-05</b>			

### How To Order

		<b>Options</b>	
<b>A</b>		LMKM	-Latch And Keeper Monitor
	<b>65</b>		
	S	-Standard	
	L	-Low Profile	
		<b>Profile</b>	
Example: <b>AL65LMKM</b>			

### How To Order

		<b>Voltage</b>	
<b>Fail-Secure</b>		11-16VAC-	01
		12VDG-	05D
		24VAC-	07
		24VDC-	08D
<b>Fail-Safe</b>		12VDC-	06
		24VDC-	09
<b>A</b>	<b>7</b>	-	
	1	-Fail-Secure	
	3	-Fail-Safe	
		<b>Mode</b>	
Example: <b>A71-05D</b>			

Model	Description	List Price
A41	41 Series without Faceplate, 16VAC/12V/24V	\$181.00
A43	43 Series without Faceplate 12VDC/24VDC	\$195.00
AL65	Low Profile Strike, 12 to 24 VAC & 12/24VDC x32D	\$226.00
AS65	Standard Profile Strike, 12 to 24 VAC & 12/24VDC x32D	\$226.00
AL65-LMKM	Low Profile LMKM Strike, 12 to 24 VAC & 12/24VDC x32D	\$292.00
AS65-LMKM	Standard Profile LMKM Strike, 12 to 24 VAC & 12/24VDC x32D	\$292.00
A71	71 Series without Faceplate, 16VAC/12VDC/24VAC/24VDC	\$168.00
A73	73 Series without Faceplate, 12VDC/24VDC	\$182.00

# RCI Electric Strikes

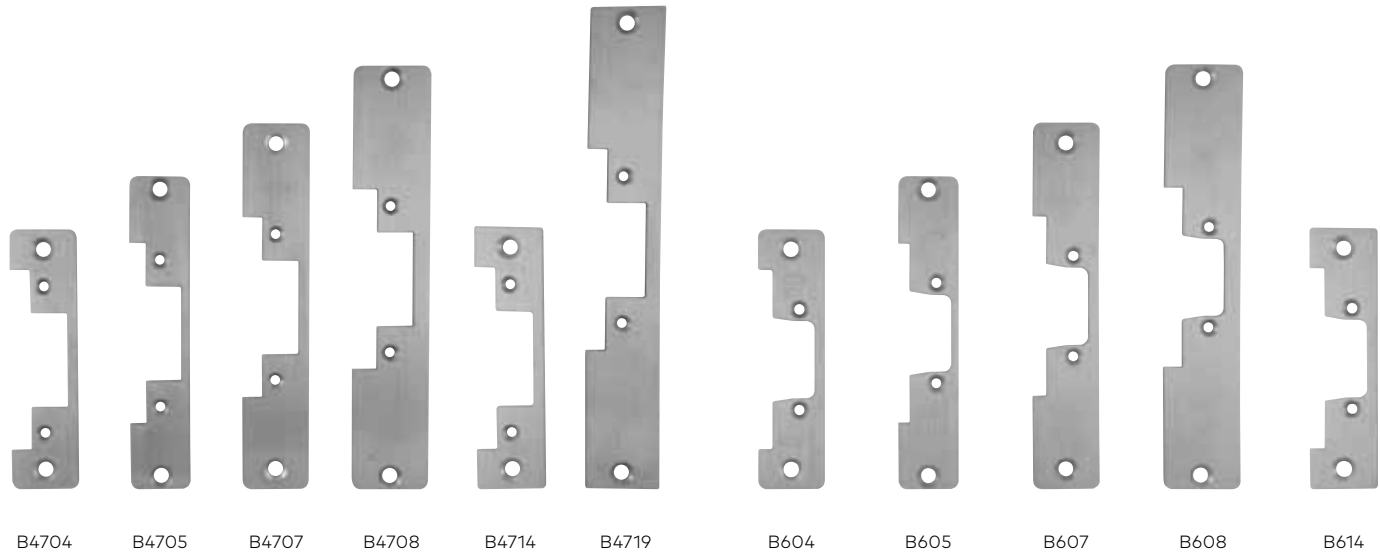

## 4/7 Series

### Modular Strike Faceplates

Model	Description	List Price
B4704-32D	Faceplate Aluminum Frames 1-1/4"x4-7/8"x32D	\$31.00
B4714-32D	Faceplate Hollow Metal Frames 1-1/4"x4-7/8"x32D	\$31.00
B4705-32D	Faceplate Aluminum Frames 1-1/8"x5-7/8"x32D	\$38.00
B4707-32D	Faceplate Aluminum Frames 1-1/4"x6-7/8"x32D	\$38.00
B4708-3D	Faceplate aluminum/Wood Frames 1-7/16"x7-15/16"x32D	\$45.00
B4719-32D	Faceplate Hollow Metal/Wood Frames 1-3/8"x9"x32D. (Must add 47LIP9B)	\$45.00
47LIP9B	Lip Bracket for use with #19 Faceplate	\$50.00

## 6 Series

### Modular Strike Faceplates

Model	Description	List Price
B6-04-32D	Faceplate Aluminum/Wood Frames 1-1/4"x4-7/8"x32D	\$29.00
B6-14-32D	Faceplate Steel/Wood Frames 1-1/4"x4-7/8"x32D	\$29.00
B6-05-32D	Faceplate Aluminum/Wood Frames 1-1/8"x5-7/8"x32D	\$35.00
B6-07-32D	Faceplate Aluminum/Wood Frames 1-1/4"x6-7/8"x32D	\$35.00
B6-08-32D	Faceplate Aluminum/Wood Frames 1-7/16"x7-15/16"x32D	\$42.00

#### How To Order

Series	
6	-6 Series
47	-4 & 7 Series
B	- 32D
04	-1-1/4"W x 4-7/8"H (32mm x 124mm), ANSI Radius Corner
05	-1-1/8"W x 5-7/8"H (29mm x 150mm), Radius Corners
07	-1-1/4"W x 6-7/8"H (32mm x 175mm), Radius Corners
08	-1-7/16"W x 7-15/16"H (37mm x 202mm), Radius Corners
14	-1-1/4"W x 4-7/8"H (32mm x 124mm), ANSI Square Corners
19	-1-3/8"W x 9"H (34mm x 229mm), Square Corners <sup>1</sup>

#### Faceplate

Example: **B4707-32D**

<sup>1</sup>Only available with 4 & 7 series

# RCI Electric Strikes Accessories



## Double Door Housing

Ideal for double door applications with no center mullion. Door housing is mounted on the inactive door

Model	Description	Finish	Compatible with	List Price
0161DDH	Double door housing for	SPC <sup>1</sup>	0161	\$208.00
0162DDH	Double door housing for	SPC <sup>1</sup>	0162, 0163, 0563	\$208.00

<sup>1</sup>SPC = Silver Powder Coat



## Latch Guards

Added tamper-resistance for perimeter doors. Helps guard the latch from a prying attack. Designed with radius cut for easy installation around lockset roses.

Model	Description	Finish	Compatible with	List Price
930-LG	Standard profile latch guard	32D	4/7 Series	\$70.00
940-LG	High profile latch guard	32D	F2/6/F1 Series	\$62.00



## Frame Prep Jigs

Aids in cutting of aluminum or metal frames, improving accuracy.

Model	Description	Finish	Compatible with	List Price
4/7JIG	Frame prep jig for ANSI-sized electric strike	Aluminum	4104/4304, 4114/4314, 7104/7304, 7114/7314	\$111.00
S6JIG	Standard profile frame prep jig	Aluminum	S6504, S6514	\$88.00
L6JIG	Low profile frame prep jig	Aluminum	L6504, L6514	\$88.00



## Lip Bracket Extension

Ideal for center-hung doors. Allows electric strike to be installed in frame and protects frame from damage.

Model	Description / Dimensions	Finish	Compatible with	List Price
LEK01	1" Lip extension kit for retrofit	Black	4/7 Series	\$88.00
LEK02	2" Lip extension kit for retrofit	Black	4/7 Series	\$99.00
LEK03	3" Lip extension kit for retrofit	Black	4/7 Series	\$117.00
LEKS601	1" Lip extension kit for retrofit (standard)	Black	S6 Series	\$63.00
LEKS602	2" Lip extension kit for retrofit (standard)	Black	S6 Series	\$76.00
LEKS603	3" Lip extension kit for retrofit (standard)	Black	S6 Series	\$88.00
LEKL601	1" Lip extension kit for retrofit (low profile)	Black	L6 Series	\$63.00
LEKL602	2" Lip extension kit for retrofit (low profile)	Black	L6 Series	\$76.00
LEKL603	3" Lip extension kit for retrofit (low profile)	Black	L6 Series	\$88.00



## Ice Pack

Heat reducer for continuous duty electric strikes. Operating voltage – 12 to 30VDC.

Model	Description / Dimensions	Compatible with	List Price
ICEPK	Heat reducer for continuous duty electric strikes	0/F1/2/4/6/7 Series	\$114.00



## Mounting Spacer Kits

Ideal for increasing latch depth.

Model	Description	Compatible with	List Price
0162MSK	1/16" mounting spacer for additional latch engagement	0162	\$15.00

# RCI Electric Strikes Accessories



## Strike Marking Template Kit

Ideal for accurately guiding prepping of the frame for the installation.

Model	Description	Finish	Compatible with	List Price
SMT-01	Strike Marking Template Kit	Aluminum	F2/4/6/7 Series	\$70.00



## 2 Series Plug-In Latch Monitor

Latch monitor plug-in kit (2A @ 24VDC).

Model	Description	Compatible with	List Price
F2LM	Plug-in latch monitor kit (2A @ 24VDC). Improved design to accommodate 1/2" - 3/4" latch throw	F2164	\$86.00



## Trim Plates

Ideal for concealing any imperfections caused while prepping the frame cut out.

Model	Description	Finish	Compatible with	List Price
TP-47-5PK	Trim Plate - 5 Pack	Black	4/7 Series	\$33.00
TP-L6-5PK	Low profile Trim Plate - 5 Pack	Black	L6 Series	\$27.00
TP-S6-5PK	Standard profile Trim Plate - 5 Pack	Black	S6 Series	\$27.00



## 2 Series Filler Plate

Filler plate (for use when replacing discontinued 2 Series models).

Model	Description	Compatible with	List Price
2FP	Filler plate for use when replacing discontinued 2 Series models	F2164/2364	\$24.00



## Security Hardware Packs

Model	Description	Compatible with	List Price
2SERIESHWK	Includes screws, bit, mounting tabs, allen key, shims, connetor, deadbolt bracket and plug.	2 Series	\$65.00
6HK9	6 Series L/S Hardware Pack		\$27.00
47HK9	Standard Strike Mounting Hardware		\$27.00



## 6 Series Lip Bracket & Aluminum Faceplates

Model	Description	Compatible with	List Price
S6504DD	Lip bracket and aluminum faceplate for double doors with astragal (for S6504)	S6504	\$63.00
L6504DD	Lip bracket and aluminum faceplate for double doors with astragal (for L6504)	L6504	\$63.00
S6507DD	Lip bracket and aluminum faceplate for double doors with astragal (for S6507)	S6507	\$68.00
L6507DD	Lip bracket and aluminum faceplate for double doors with astragal (for L6507)	L6507	\$68.00



# Keypads & Readers



# RCI 125 kHz Readers



## P-300-H-A

### 125kHz Mullion Reader

Slim design ideal for areas with minimal surface space to mount.

1-11/16" W x 3-3/16" H x 11/16" D  
(43 x 80 x 17mm)



## P-500-H-A

### 125kHz Reader

Compact design ideal for single gang wall-box applications.

3" W x 4-5/8" H x 3/8" D  
(76 x 117 x 10mm)



## P-640-H-A

### P-620-H-A (mullion)

### 125kHz Keypad & Reader

Ideal for dual authentication or simple access via PIN or credential applications.

620: 1.78" W x 6.1" H x 0.91" D (45x155x23 mm)  
640: 3" W x 4.6" H x 0.75" D (76x117x19 mm)



## P-710-H-A

### 125kHz Medium Range Reader

Slim design ideal for areas with minimal surface space to mount.

6" W x 8.5" H x 1" D (216 x 152 x 25.4 mm)



## P-900-H-A

### 125kHz Long Range Reader

Slim design ideal for areas with minimal surface space to mount.

10.5" H x 10.5" W x 2" D (267 x 267 x 51 mm)

Model	Description	List Price
P-300-H-A	125kHz Wiegand Mullion Proximity Reader	\$178.00
P-300-H-A-OSDP	125kHz Wiegand Mullion Proximity Reader OSDP version	\$289.00
P-500-H-A	125kHz Wiegand Proximity Reader	\$274.00
P-500-H-A-OSDP	125kHz Wiegand Proximity Reader OSDP version	\$264.00
P-640-H-A	125kHz Wiegand Proximity Keypad & Reader	\$516.00
P-640-H-A-OSDP	125kHz Wiegand Proximity Keypad & Reader OSDP version	\$478.00
P-620-H-A	125kHz Wiegand Mullion Proximity Keypad & Reader	\$516.00
P-620-H-A-OSDP	125kHz Wiegand Mullion Proximity Keypad & Reader OSDP version	\$466.00
P-710-H-A	125kHz Wiegand Proximity Medium Range Reader	\$654.00
P-710-H-A-OSDP	125kHz Wiegand Proximity Medium Range Reader OSDP version	\$519.00
P-900-H-A	125kHz Wiegand Proximity Long Range Reader	\$932.00
P-900-H-A-OSDP	125kHz Wiegand Proximity Long Range Reader OSDP version	\$821.00

#### How To Order

##### Reader Type

300	-Mullion
500	-Single gang
620	-Mullion keypad
640	-Keypad
710	-Medium range
900	-Long range

P		H	A
---	--	---	---

# RCI 125 kHz Credentials



## PSC-1-H

### 125kHz Clamshell Card

Proximity card for physical access control.  
2.2" W x 3.4" H x .06" D  
(56x86x1.5 mm)

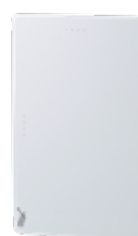

## PSI-4-H

### 125kHz Printable Card

Printable proximity card for physical access control.  
2.1" W x 3.4" H x 0.046" D  
(53x86x1.17 mm)



## PSM-2P-H

### 125kHz ISO Imageable Card

ISO imageable proximity card for physical access control.  
2.1" W x 3.4" H x 0.031" D  
(53 x 86 x 0.79 mm)



## PSM-2S-H

### 125kHz ISO Imageable Card with magnetic stripe

ISO imageable proximity card for physical access control.  
2.1" W x 3.4" H x 0.031" D  
(53 x 86 x 0.79 mm)



## PSK-3-H

### 125kHz Fob

Proximity fob for physical access control.  
1.2" W x 1.5" H x 0.15" D  
(30 x 38 x 3.8 mm)



## PDT-1-H

### 125kHz Disk Tag

Disk tag credential for physical access control.  
1" diameter x 0.0625" thick  
(25.4 mm x 1.6 mm)



## DE2-125

### 125kHz & 13.56MHz Card

Dual frequency 125 kHz (proximity) and 13.56 MHz (MIFARE DESFire EV2 smartcard) for physical access control.  
2.1" W x 3.4" H x 0.031" D  
(53 x 86 x 0.79 mm)

#### How To Order

	Credential Type
PSC-1-H	Clamshell
PSI-4-H	Printable
PSM-2P-H	ISO imageable
PSM-2S-H	ISO imageable
PSK-3-H	Fob
PDT-1-H	Adhesive Tag
DE2-125	ISO imageable

Model	Description	List Price
PSC-1-H	Proximity Card (Clamshell) - 25 Pack	\$112.00
PSI-4-H	Proximity Card (Printable) - 25 Pack	\$143.00
PSM-2P-H	Proximity Card (ISO imageable) - 25 Pack	\$197.00
PSM-2S-H	Proximity Card with magnetic stripe (ISO imageable) - 25 Pack	\$243.00
PSK-3-H	Proximity Fob - 25 Pack	\$207.00
PDT-1-H	Proximity Tag (adhesive) - 25 Pack	\$156.00
DE2-125	Dual Frequency Proximity Card (for Prox and Smartcard applications) - 25 Pack	\$372.00

# RCI 13.56 MHz Smartcard Readers



## CSR-35L

### 13.56MHz Smartcard & BLE Reader

Unique design accommodates single gang or mullion mounts.  
 Functions with 13.56MHz physical and mobile (BLE) credentials  
 Mullion: 1.7" W x 4.7" H x 1.2" D (43 x 119 x 30 mm)  
 Switch Plate: 3" W x 5.1" H x 1.2" D (76 x 130 x 30 mm)  
 Also available in OSDP



## CSR-6.2L

### CSR-6.4L (mullion)

### 13.56MHz Smartcard & BLE Keypad Reader

Ideal for dual authentication or simple access via PIN or credential applications.  
 CSR-6.2L: 1.78" W x 6.1" H x 0.91" D (45 x 155 x 23 mm)  
 CSR-6.4L: 3" W x 4.6" H x 0.75" D (76 x 117 x 19 mm)  
 Also available in OSDP



## PCR-35L

### 125kHz & BLE Reader

Unique design accommodates single gang or mullion mounts.  
 Functions with 125 kHz physical and mobile (BLE) credentials  
 Mullion: 1.7" W x 4.7" H x 1.2" D (43 x 119 x 30 mm)  
 Switch Plate: 3" W x 5.1" H x 1.2" D (76 x 130 x 30 mm)  
 Also available in OSDP



## PCR-620L

### PCR-640L (mullion)

### 125kHz & BLE Keypad Reader

Ideal for dual authentication or simple access via PIN or credential applications.  
 CSR-6.2L: 1.78" W x 6.1" H x 0.91" D (45 x 155 x 23 mm)  
 CSR-6.4L: 3" W x 4.6" H x 0.75" D (76 x 117 x 19 mm)  
 Also available in OSDP

Model	Description	List Price
CSR-35L	13.56MHz Smartcard & BLE Reader	\$396.00
CSR-35L-OSDP	13.56MHz Smartcard & BLE Reader OSDP version	\$429.00
CSR-6.2L	13.56MHz Smartcard & BLE Mullion Keypad Reader	\$623.00
CSR-6.2L-OSDP	13.56MHz Smartcard & BLE Mullion Keypad Reader OSDP version	\$697.00
CSR-6.4L	13.56MHz Smartcard & BLE Keypad Reader	\$648.00
CSR-6.4L-OSDP	13.56MHz Smartcard & BLE Keypad Reader OSDP version	\$765.00
PCR-35L	125kHz Prox & BLE Reader	\$396.00
PCR-35L-OSDP	125kHz Prox & BLE Reader OSDP version	\$485.00
PCR-620L	125kHz Prox & BLE Mullion Keypad Reader	\$665.00
PCR-620L-OSDP	125kHz Prox & BLE Mullion Keypad Reader OSDP version	\$717.00
PCR-640L	125kHz Prox & BLE Keypad Reader	\$665.00
PCR-640L-OSDP	125kHz Prox & BLE Keypad Reader OSDP version	\$717.00

#### How To Order

		Reader Type
CSR	35L	-Single gang/ Mullion
CSR	6.2L	-Mullion keypad
CSR	6.4L	-Keypad
PCR	35L	-Single gang/ Mullion
PCR	620L	-Mullion keypad
PCR	640L	-Keypad

# RCI 13.56 MHz Smartcard Credentials



## CMC-2

### Mobile Credential

Smartphone (iPhone & Android) mobile credential for use with mobile ready-readers CSR/PCR series readers.



## CSC-2

### 13.56MHz Clamshell Card

MiFare DESFire EV2 smartcard for physical access control.  
2.1" W x 3.4" H x .07" D  
(54 x 86 x 1.8 mm)



## CSM-2P

### 13.56MHz ISO-Style Card

MiFare DESFire EV2 ISO imageable smartcard for physical access control.  
2.1" W x 3.4" H x 0.03" D  
(54 x 86 x 0.76 mm)



## CSM-2S

### 13.56MHz ISO-Style Card with magnetic stripe

MiFare DESFire EV2 ISO imageable smartcard for physical access control.  
2.1" W x 3.4" H x 0.03" D  
(54 x 86 x 0.76 mm)



## CSK-2

### 13.56MHz Fob

MiFare DESFire EV2 smart fob for physical access control.  
1.9" W x 1.5" H x 0.28" D  
(49 x 38 x 7 mm)

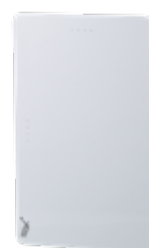

## DE2-125

### 125kHz & 13.56MHz Card

Dual frequency 125 kHz (proximity) and 13.56 MHz (MIFARE DESFire EV2 smartcard) for physical access control.  
2.1" W x 3.4" H x 0.031" D  
(53 x 86 x 0.79 mm)

Model	Description	List Price
CMC-2	BLE Mobile Credential (hosted via Conekt Wallet App for smartphones) - 25 Pack	\$259.00
CSC-2	MiFare DesFire EV2 Smartcard (Clamshell) - 25 Pack	\$218.00
CSM-2P	MiFare DesFire EV2 Smartcard (Printable) - 25 Pack	\$232.00
CSM-2S	MiFare DesFire EV2 Smartcard with magnetic stripe (ISO imageable) - 25 Pack	\$259.00
CSK-2	MiFare DesFire EV2 Smart Fob - 25 Pack	\$245.00
DE2-125	Dual Frequency Proximity Card (for Smartcard and Prox applications) - 25 Pack	\$372.00

## How To Order

	Credential Type
CMC-2	Mobile Credential
CSC-2	Clamshell card
CSM-2P	ISO imageable
CSM-2S	ISO imageable with magnetic stripe
CSK-2	Fob
DE2-125	ISO imageable



# RCI Receivers & Transmitters



## WRR-44

### 4-Channel Receiver

433MHz 4-channel Wiegand output long-range receiver. Read range up to 200 ft (61m)  
3.4" W x 6.3" H x 2.3" D  
(86.4 x 160 x 58.4 mm)



## WRR-22

### 2-Channel Receiver

433MHz 2-channel Wiegand output long-range receiver. Read range up to 100 ft (30.5m)  
3.4" W x 6.3" H x 2.3" D  
(86.4 x 160 x 58.4 mm)



## WRT-2M

### 2 button mini transmitter

433 MHz rolling code and encrypted; read range: WRR-22 Up to 75 feet (23 m), WRR-44 Up to 150 feet (46 m)  
1.4" W x 1.95" H x 0.47" D  
(35.6 x 49.5 x 11.9 mm)



## WRT-2+H

### 2 button transmitter

Button press – 433 MHz rolling code and encrypted.  
Presentation – 125 kHz proximity  
Range: Button press Up to 200 feet (61 m),  
Presentation Up to 3.5 inches (88 mm)  
1.45" W x 2.5" H x 0.56" D  
(37 x 63.5 x 14.2 mm)



## WRT-2+D2

### 2 button transmitter

Button press – 433 MHz rolling code and encrypted.  
Presentation – 13.56 MHz MIFARE DESFire EV2  
Range: Button press Up to 200 feet (61 m),  
Presentation Up to 3.5 inches (88 mm)  
1.45" W x 2.5" H x 0.56" D  
(37 x 63.5 x 14.2 mm)



## WRT-4+H

### 4 button transmitter

Button press – 433 MHz rolling code and encrypted.  
Presentation – 125 kHz Proximity  
Range: Button press Up to 200 feet (61 m),  
Presentation Up to 3.5 inches (88 mm)  
1.45" W x 2.5" H x 0.56" D  
(37 x 63.5 x 14.2 mm)



## WRT-4+D2

### 4 button transmitter

Button press – 433 MHz rolling code and encrypted.  
Presentation – 13.56 MHz MIFARE DESFire EV2  
Range: Button press Up to 200 feet (61 m),  
Presentation Up to 3.5 inches (88 mm)  
1.45" W x 2.5" H x 0.56" D  
(37 x 63.5 x 14.2 mm)

#### How To Order

	Receiver / Transmitter Type
WRR-44	4 channel long range receiver
WRR-22	2 channel long range receiver
WRT-2M	2 button mini transmitter
WRT-2+H	2 button (125kHz presentation)
WRT-2+D2	2 button 13.56MHz presentation
WRT-4+H	4 button 125kHz presentation
WRT-4+D2	4 button 13.56MHz presentation

Model	Description	List Price
WRR-44	4 channel long range receiver	\$726.00
WRR-44-OSDP	4 channel long range receiver - OSDP version	\$865.00
WRR-22	2 channel long range receiver	\$536.00
WRR-22-OSDP	2 channel long range receiver - OSDP version	\$613.00
WRT-2M	2 button mini transmitter (10 pk)	\$480.00
WRT-2+H	2 button 125kHz presentation; 433MHz rolling code/encrypted transmitter (10 pk)	\$523.00
WRT-2+D2	2 button 13.56MHz presentation; 433MHz rolling code/encrypted transmitter (10 pk)	\$654.00
WRT-4+H	4 button 125kHz presentation; 433MHz rolling code/encrypted transmitter (10 pk)	\$523.00
WRT-4+D2	4 button 13.56MHz presentation; 433MHz rolling code/encrypted transmitter (10 pk)	\$654.00

# RCI Keypads & Readers



## 9212i Keypad

Single door standalone access control solution for single gang flush mount applications.  
For interior use.  
2-3/4"W x 4-1/2"H x 1-1/4"D (70mm x 114mm x 32mm)

Model	Description	List Price
9212i x 32D	Indoor Standalone Keypad 12/24VAC or VDC x 32D	\$261.00

### How To Order

	<b>Type</b>
9212	i -Interior



## 9212iLW Illuminated Keypad

Single door standalone access control solution for single gang flush mount applications.  
For interior or exterior use.  
3-3/8"W x 5-1/8"H x 5/8"D (86mm x 130mm x 16mm)

Model	Description	List Price
9212iLW x 32D	Outdoor Illuminated Standalone Keypad 12/24VAC or VDC x 32D	\$476.00

### How To Order

	<b>Type</b>
9212	iLW -Interior or Exterior Illuminated

# RCI Keypads & Readers



## 9320 Easy Read-Prox® Slimline Reader Reader + Stand Alone

One self-contained unit, single-door standalone access control solution for surface or mullion mount for interior or exterior use.

1-1/2"W x 3-1/16"H x 1/2"D (38mm x 78mm x 12.7mm)

## 9321 Easy Read-Prox® Slimline Reader Reader + Controller

Two separate components, single-door standalone access control solution for surface or mullion mount for interior or exterior use.

1-1/2"W x 3-1/16"H x 1/2"D (38mm x 78mm x 12.7mm)

Model	Description	List Price
9320	Easy Read Proximity Slimline Reader 12VDC	\$363.00

Model	Description	List Price
9321	Easy Read Proximity Slimline Reader/Controller Kit 12VDC	\$482.00
9321SPB	Proximity Reader Only	\$287.00

### How To Order

Type	
0	-Reader + Controller (One Self-Contained Unit)
1	-Reader + Controller (Two Separate Components)
1SPB	-Reader Only (No Control Board)
932	



# RCI Keypads & Readers



## 9322 Easy Read-Prox® Micro Reader Reader + Stand Alone

One self-contained unit, single door standalone access control solution for flush mount applications for interior or exterior use. 1-3/16"W x 1-7/8"H x 5/16"D (29.5mm x 48mm x 8.5mm)



## 9323 Easy Read-Prox® Micro Readers Reader + Controller

Two separate components, single door standalone access control solution for flush mount applications for interior or exterior use. 1-3/16"W x 1-7/8"H x 5/16"D (29.5mm x 48mm x 8.5mm)

Model	Description	List Price
9322	Easy Read Proximity Micro Reader 12VDC	\$403.00
9323	Easy Read Proximity Micro Reader/Controller Kit 12VDC	\$551.00
9323MP	Easy Read Proximity Micro Reader Only	\$328.00

### How To Order

Type	Description
2	-Reader + Controller (One Self-Contained Unit)
3	-Reader + Controller (Two Separate Components)
3MP	-Reader Only (No Control Board)

932

9 Series Easy Read-Prox® Accessories		List Price
932-10CP	Encoded Card Token Pack, 10 Count	\$252.00
932-10KP	Encoded Keyfob Token Pack, 10 Count	\$252.00
932-PEC	Enrollment Card+	\$24.00
932-10UKP	Unencoded Keyfob Token, 10 Pack	\$95.00
932-25UKP	Unencoded Keyfob Token, 25 Pack	\$222.00
932-50UKP	Unencoded Keyfob Token, 50 Pack	\$422.00
932-10UCP	Unencoded Card Token, 10 Pack	\$95.00
932-25UCP	Unencoded Card Token, 25 Pack	\$222.00
932-50UCP	Unencoded Card Token, 50 Pack	\$422.00

# Switches



# RCI Switches



## 906 Handicap Pushbutton

2-3/4"W x 4-1/2"H (70mm x 114mm)

906 Handicap Button		List Price
906-MO x 32D	Momentary	\$151.00
906-MA x 32D	Maintained	\$151.00
906-TD x 32D	Electronic Time Delay	\$231.00

### How To Order

		Type			
906	-	BH	-Handicap Symbol	x	
		B	-Blank		
					32D
		Momentary	MO		
		Maintained	MA		
		Time-Delay	TD		
		<b>Switch Mode</b>			



## 908 Exit Pushbutton

2-3/4"W x 4-1/2"H (70mm x 114mm)

908 Exit Button		List Price
908-MO x 32D	Momentary Exit MB	\$144.00
908-MA x 32D	Maintained Exit MB x 32D	\$144.00
908-TD x 32D	Electronic Time Delay Exit MB	\$223.00

### How To Order

		Type			
908	-	E	- "EXIT", English	-	x
		R	- "EXIT", French		
		G	- "EXIT", Spanish		
		B	-Blank		
					32D
		Momentary	MO		
		Maintained	MA		
		Time-Delay	TD		
		<b>Switch Mode</b>			

<sup>1</sup>Standard

# RCI Switches



## 916 Tamper-Resistant Handicap Pushbutton

Standard: 3"W x 4-3/4"H (76mm x 121mm)  
Narrow: 1-5/8"W x 4-3/4"H (45mm x 121mm)

916 Tamper-Resistant Handicap Button		List Price
916-MO x 28	Momentary	\$163.00
916-MA x 28	Maintained	\$163.00
916-TD x 28	Electronic Time Delay	\$245.00
916N-MO x 28	Narrow, Momentary	\$163.00
916N-MA x 28	Narrow, Maintained	\$163.00
916N-TD x 28	Narrow, Electronic Time Delay	\$245.00
40 Finish		N/C

### How To Order

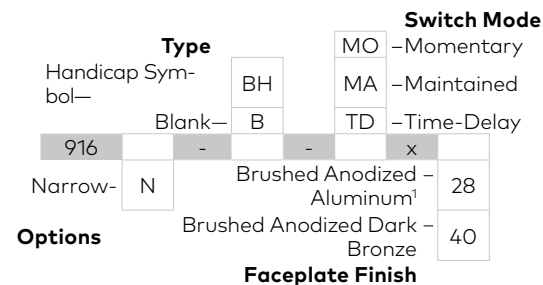

<sup>1</sup>Standard



## 918 Tamper-Resistant Exit Pushbutton

Standard: 3"W x 4-3/4"H (76mm x 121mm)  
Narrow: 1-5/8"W x 4-3/4"H (45mm x 121mm)

918 Tamper-Resistant/916N Narrow Tamper-Resistant Exit Button		List Price
918-MO x 28	Momentary	\$158.00
918-MA x 28	Maintained	\$158.00
918-TD x 28	Electronic Time Delay	\$237.00
918N-MO x 28	Narrow, Momentary	\$158.00
918N-MA x 28	Narrow, Maintained	\$158.00
918N-TD x 28	Narrow, Electronic Time Delay	\$237.00
40 Finish		N/C

### How To Order

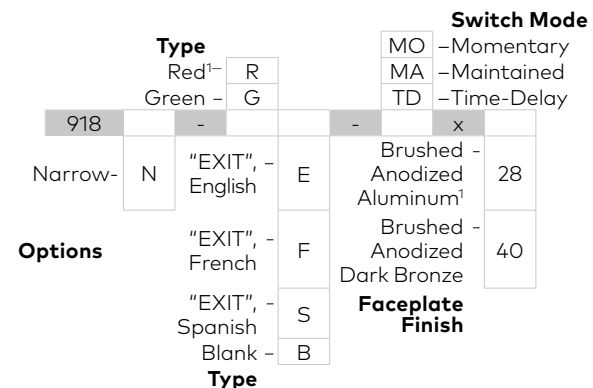

<sup>1</sup>Standard

# RCI Switches



## 990 Oversized Tamper-Resistant Handicap Pushbutton

3"W x 4-3/4"H (76mm x 121mm)

990 Oversized Tamper-Resistant Handicap Button		List Price
990-MO x 28	Momentary Handicap	\$180.00
990-MA x 28	Maintained Handicap	\$180.00
990-TD x 28	Electronic Time Delay Handicap	\$282.00
40 Finish		N/C



## 990 Oversized Tamper-Resistant Exit Pushbutton

3"W x 4-3/4"H (76mm x 121mm)

990 Oversized Tamper-Resistant Button		List Price
990-MO x 28	Momentary Exit	\$180.00
990-MA x 28	Maintained Exit	\$180.00
990-TD x 28	Electronic Time Delay Exit	\$282.00
40 Finish		N/C

### How To Order

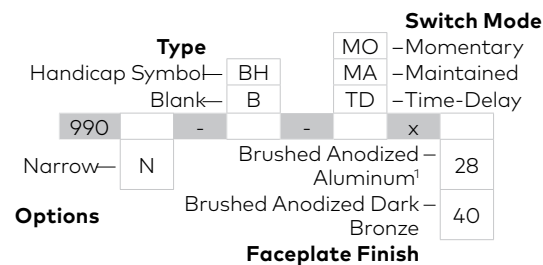

<sup>1</sup>Standard

### How To Order

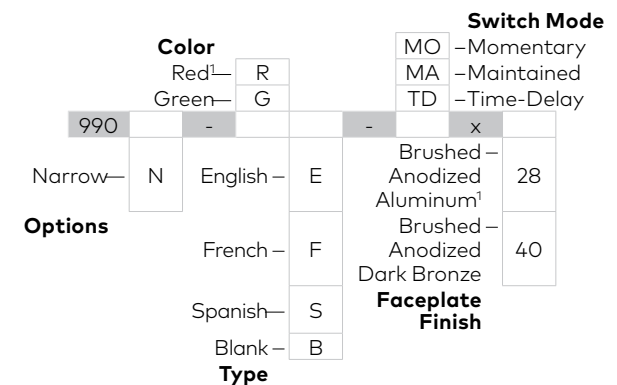

<sup>1</sup>Standard

# RCI Switches



## 991 Pneumatic Time Delay Handicap Pushbutton

Standard: 2-3/4"W x 4-1/2"H (70mm x 114mm)

Narrow: 1-3/4"W x 4-1/2"H (41mm x 114mm)

991 Pneumatic Time Delay Handicap Button		List Price
991-BBPTDX32D	Standard single gang Blue, Blank button in 32D	\$443.00
991-BHPTDX32D	Standard single gang Blue, Handicap logo button in 32D	\$443.00
991-RBPTDX32D	Standard single gang Red, Blank button in 32D	\$443.00
991-REPTDX32D	Standard single gang Red, Push to Exit button in 32D	\$443.00
991N-BBPTDX32D	Narrow Mullion Plate, Blue, Blank button in 32D	\$443.00
991N-BHPTDX32D	Narrow Mullion Plate, Blue, Handicap logo button in 32D	\$443.00
991N-RBPTDX32D	Narrow Mullion Plate, Red, Blank button in 32D	\$443.00
991N-REPTDX32D	Narrow Mullion Plate, Red, Push to Exit button in 32D	\$443.00

### How To Order

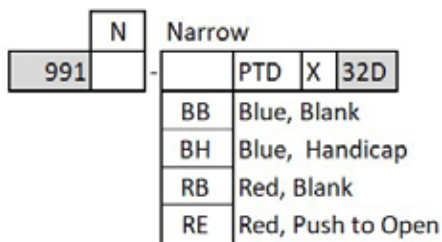

Example = 991N-BHX32D

991 Narrow Blue with Handicap Logo

# RCI Switches



## 919 Rotary Release Pushbutton

3"W x 4-1/2"H (76mm x 114mm)

919 Rotary Release Button		List Price
919-MA x 28	Rotary-Release Exit Maintained	\$193.00
40 Finish		N/C

### How To Order

#### Faceplate Finish

Brushed Anodized – Aluminum <sup>1</sup>	28
Brushed Anodized – Dark Bronze	40

919 - MA x

<sup>1</sup>Standard



## 920 Emergency Release Keyswitch/ Pushbutton

2-3/4"W x 4-1/2"H (70mm x 114mm)

920 Emergency Release Button/Keyswitch		List Price
920MA x 32D	Emergency Release Maintained Red (2-SPST) Locking. Tamper-proof Fasteners	\$237.00

### How To Order

920 - MA x 32D

# RCI Switches



## 917 Easy Touch Pushbutton

2-3/4"W x 4-1/2"H (70mm x 114mm)

917 Easy Touch Exit Pushbutton		List Price
917 - MO x 28	Easy Touch Exit Push Button 12-40VDC	\$395.00

### How To Order

917 - MO x 28



## 972 All-In-One Illuminated Pushbutton

2-3/4"W x 4-1/2"H (70mm x 114mm)

972 All-In-One Illuminated Pushbutton		List Price
972-L-EF-MO x 32D	English/French Momentary	\$68.00
972-L-EF-TD30-MO x 32D	English/French Momentary With 30sec. Fixed Timer	\$138.00
972-L-EF-TD30A-MO x 32D	English/French Momentary With 0-30sec. Adjustable Timer	\$138.00

### How To Order

		Options	
972	-	TD30	-30 Sec. Fixed Timer
		TD30A	-0-30 Sec. Adjustable Time
		ES	-English & Spanish
		EF	-English & French
		<b>Language</b>	
			- MO x 32D



# RCI Switches



## 970 Illuminated Exit Pushbutton

Standard: 3" W x 4-3/4" H (76mm x 121mm)  
Narrow: 1-5/8" W x 4-3/4" H (41mm x 121mm)

970 Tamper-Resistant Exit Button		List Price
970-MO-12 x 28	Momentary 12VDC Blue Exit Button	\$118.00
970-MO-24 x 28	Momentary 24VDC Blue Exit Button	\$118.00
970-MA-12 x 28	Maintained 12VDC Blue Exit Button	\$118.00
970-MA-24 x 28	Maintained 24VDC Blue Exit Button	\$118.00
970-TD-12 x 28	Electronic Time Delay 12VDC Blue Exit Button	\$208.00
970-TD-24 x 28	Electronic Time Delay 24VDC Blue Exit Button	\$208.00
970N-MO-12 x 28	Narrow Momentary 12VDC Blue Exit Button	\$118.00
970N-MO-24 x 28	Narrow Momentary 24VDC Blue Exit Button	\$118.00
970N-MA-12 x 28	Narrow Maintained 12VDC Blue Exit Button	\$118.00
970N-MA-24 x 28	Narrow Maintained 24VDC Blue Exit Button	\$118.00
970N-TD-12 x 28	Narrow Time Delay 12VDC Blue Exit Button	\$208.00
970N-TD-24 x 28	Narrow Time Delay 24VDC Blue Exit Button	\$208.00
40 Finish		N/C

### How To Order

<b>Lens</b>		<b>Faceplate Finish</b>	
Blue <sup>1</sup>	B	Brushed Anodized Aluminum <sup>1</sup>	28
Yellow	Y		
Green	G	<b>Options</b>	
Red	R	Audible Alert	A
		Brushed Anodized Dark Bronze	40
970	-	-	x
Narrow	N	Momentary	MO
		Maintained	MA
		2x Momentary	DMO
		2x Maintained	DMA
		Time-Delay	TD
		<b>Switch Mode</b>	
		12VDC	05
		24VDC	08
		<b>Voltage</b>	

<sup>1</sup>Standard



## 975 Illuminated Exit Pushbutton

Standard: 3" W x 4-3/4" H (76mm x 121mm)  
Narrow: 1-5/8" W x 4-3/4" H (41mm x 121mm)

975 LED Illuminated Pushbutton		List Price
975-MO-05 x 28	Momentary 12VDC	\$180.00
975-MO-08 x 28	Momentary 24VDC	\$180.00
975N-MO-05 x 28	Narrow, Momentary 12VDC	\$180.00
975N-MO-08 x 28	Narrow, Momentary 24VDC	\$180.00
975-TD-12V x 28	Time Delay 3" x 4-3/4" 12V x 28	\$259.00
975-TD-24V x 28	Time Delay 3" x 4-3/4" 24V x 28	\$259.00
975N-TD-12V x 28	Narrow, Time Delay 1-5/8" x 4-3/4" 12V x 28	\$259.00
975N-TD-24V x 28	Narrow, Time Delay 1-5/8" x 4-3/4" 24V x 28	\$259.00
40 Finish		N/C

### How To Order

<b>Switch Mode</b>		<b>Voltage</b>	
Momentary	MO	05	-12VAC/VDC
Time-Delay	TD	08	-24VAC/VDC
975	-	-	x
Narrow	N	Brushed Anodized Aluminum <sup>1</sup>	28
		Brushed Anodized Dark Bronze	40
		<b>Faceplate Finish</b>	

<sup>1</sup>Standard

# RCI Switches



## 980 Economy Pushbutton

2-3/4"W x 4-1/2"H (70mm x 115mm)

980 Economy Pushbutton		List Price
980-MO x 32D	Momentary Economy Pushbutton	\$97.00
980-MA x 32D	Maintined Economy Pushbutton	\$97.00
980-TD x 32D	Time-Delay Economy Pushbutton	\$186.00

### How To Order

		Switch Mode
		MO -Momentary
		MA -Maintined
		TD -Time-Delay
980	-	x 32D



## 903 Audible Alert

3"W x 4-3/4"H (76mm x 121mm)

903 Audible Alert		List Price
903 x 28	Audible Alert 3" x 4-3/4" x 28	\$163.00
903N x 28	Narrow Audible Alert 1-5/8" x 4-3/4" x 28	\$163.00
40 Finish		N/C

### How To Order

		Options
		N -Narrow stile
903	x	
Brushed Anodized - Aluminum <sup>1</sup>		28
Brushed Anodized - Dark Bronze		40
<b>Faceplate Finish</b>		

<sup>1</sup>Standard

# RCI Switches



## 960 Tamper-Resistant Keyswitch

Standard: 3" W x 4-3/4" H (76mm x 121mm)  
 Narrow: 1-5/8" W x 4-3/4" H (41mm x 121mm)  
 Key cylinder sold separately.

960 Tamper-Resistant Keyswitch		List Price
960-MO x 28	Momentary, Tamper-proof	\$136.00
960-MA x 28	Maintained, Tamper-proof	\$136.00
960-TD x 28	Pneumatic Time Delay, Tamper-proof	\$443.00
960N-MO x 28	Narrow Momentary, Tamper-proof	\$136.00
960N-MA x 28	Narrow Maintained, Tamper-proof	\$136.00
960N-TD x 28	Narrow Pneumatic Time Delay, Tamper-proof	\$443.00



## 960RO Tamper-Resistant Keyswitch with Reset/Override

Standard: 3" W x 4-3/4" H (76mm x 121mm)  
 Narrow: 1-5/8" W x 4-3/4" H (41mm x 121mm)  
 Key cylinder sold separately.

960RO Tamper-Resistant Keyswitch		List Price
960RO-MOMO	MOMO Reset/Override Screen Printed KS, Tamper-proof	\$178.00

### How To Order

		Options		Options <sup>2</sup>	
		D	-DPDT <sup>1</sup>	MO	-Momentary
				MA	-Maintained
960RO	-		-	x	28
				MO	-Momentary
				MA	-Maintained

<sup>1</sup>Only available with MO and MA switch mode  
<sup>2</sup>Second switch

### How To Order

		Options		Faceplate Finish	
		DPDT <sup>1</sup>	D	Brushed Anodized Aluminum <sup>3</sup>	28
				Brushed Anodized Dark Bronze	40
960	-			x	
Narrow-Style	N	Momentary	MO	MO	-Momentary
		Maintained	MA	MA	-Maintained
		DPDT Momentary	DMO	DMO	-DPDT Momentary
		DPDT Maintained	DMA	DMA	-DPDT Maintained
		Time-Delay	TD		

<sup>1</sup>Only available with MO and MA switch mode  
<sup>2</sup>Second switch  
<sup>3</sup>Standard



# RCI Switches



## 915 Passive Infrared

Hands-free egress switch.  
6-1/4"W x 1-13/32"H x 1-1/2"D  
(159mm x 36mm x 38mm)

915 Passive Infrared Egress Switch		List Price
915 x B	PIR 12 or 24 VDC Black	\$304.00
915 x G	PIR 12 or 24 VDC Grey	\$304.00

### How To Order

<b>Finish</b>	
Black	B
Gray	G
915	x



## IL06 Controller - Barrier Free Washroom Controller

7.25" (184.2mm) x 2.5" (63.5mm) x 1.5" (38.1mm)

Recent building code changes require several enhancements to meet Barrier Free Washroom requirements, with emphasis on emergency assistance. RCI's new IL06 controller meets and exceeds these requirements.

IL06 Controller		List Price
IL06	Electronic door controller	\$532.00
IL06KT	Electronic door controller kit	\$1,696.00



## 915AFI Active Focused Infrared

6-7/8"W x 1-7/8"H x 2"D (175mm x 48mm x 51mm)

915AFI Passive Infrared Egress Switch		List Price
915AFI x B	Request to Exit Detector, Active Focused Infrared 12-24V AC/DC - Black	\$237.00

### How To Order

915AFI	x	B
--------	---	---

### How To Order

Part	Description
IL06	Controller
IL06KT	Controller kit

Kit Includes		Qty
IL06	IL06 barrier free controller	1
P921	Light Annunciator assistance	2
P9535	Magnetic door contact 1 1/4"	1
PBC6MW	In the event of emergency	1
R919MA8	919-MA X 28	1
921	Emergency light/sounder	2
R950HP69	950 6" RD HANDI/PTO MO DOOR	2
R972LEFMO9	972L X EF X MO X 32D	1

# RCI Switches



## 946 Square Push Plate

4-1/2" Sq. (114mm)  
4-3/4" Sq. (121mm)  
6" Sq. (152mm)

## 950 Round Push Plate

4-1/2" Dia. (114mm)  
6" Dia. (152mm)

946 Square Pushplates		List Price
946HP45-MO x 32D	4-1/2" Square Plate with Handicap Logo and Push to Open Text, Momentary	118.00
946H45-MO x 32D	4-1/2" Square Plate with Handicap Logo, Momentary	118.00
946HP475-MO x 32D	4-3/4" Square Plate with Handicap Logo and Push to Open Text, Momentary	118.00
946H475-MO x 32D	4-3/4" Square Plate with Handicap Logo, Momentary	118.00
946HP6-MO x 32D	6" Square Plate with Handicap Logo and Push to Open Text, Momentary	123.00
946H6-MO x 32D	6" Square Plate with Handicap Logo, Momentary	123.00
BLU Finish		N/C

950 Round Pushplates		List Price
950P45-MO x 32D	4-1/2" Momentary "Push to Open" (Replaces 950P4-MO)	118.00
950HP45-MO x 32D	4-1/2" Momentary Handicap & PTO (Replaces 950HP4-MO)	118.00
950H45-MO x 32D	4-1/2" Momentary Handicap (Replaces 950H4-MO)	118.00
950H6-MO x 32D	6" Momentary Large Handicap Logo Only	123.00
950P6-MO x 32D	6" Momentary "Push to Open"	123.00
950HP6-MO x 32D	6" Momentary Handicap & PTO 6"	123.00

### How To Order

Type		Finish	
P	-Push to Open	32D	-Brushed Stainless Steel
H	-Handicap Symbol	BLU	-Blue
HP	-Handicap Symbol + Push to Open		

946	Size	Options	Finish
4-1/2" (114mm) <sup>1</sup>	45	MO x	32D
4-3/4" (121mm)	475		
6" (152mm)	6		

<sup>1</sup>Only available with HP type

### How To Order

Type		Finish	
P	-Push to Open		
H	-Handicap Symbol		
HP	-Handicap Symbol + Push to Open		

950	Size	Options	Finish
4-1/2" (114mm)	45	MO x	32D
6" (152mm)	6		

# RCI Switches



## 946T Square Short-Range Touchless Actuator

4-3/4" Sq. (121mm)

946 Square Short-Range Touchless Actuator		List Price
946THW475	4.75" Square Touchless Short Range Actuator with Handicap Logo and Wave To Open Text	\$265.00
946TW475	4.75" Square Touchless Short Range Actuator with Wave To Open Text	\$265.00
946TH475	4.75" Square Touchless Short Range Actuator with Handicap Logo	\$265.00

### How To Order

		Type				
	H	-Handicap & Wave Symbol				
	HW	-Handicap & Wave Symbol & "Wave To Open"				
	W	-"Wave To Open" & Wave Symbol				
946T		475	-	MO	x	32D



## 950T Round Short-Range Touchless Actuator

6" Dia. (173mm x 152mm)

950 Round Short-Range Touchless Actuator		List Price
950THW6 x 32D	6" Round Touchless Short Range Actuator with Handicap Logo and Wave To Open Text	\$265.00
950TW6 x 32D	6" Round Touchless Short Range Actuator with Wave To Open Text	\$265.00
950TH6 x 32D	6" Round Touchless Short Range Actuator with Handicap Logo	\$265.00

### How To Order

		Type				
	H	-Handicap & Wave Symbol				
	HW	-Handicap & Wave Symbol & "Wave To Open"				
	W	-"Wave To Open" & Wave Symbol				
950T		6	-	MO	x	32D

# RCI Switches



RCM  
Retrofit contactless module



TWM  
Two-wire module



Converts existing Stainless Steel actuators into a touch-free solution eg. RCI 946/950

## T2T Touch to Touchless Conversion Modules

### How to Order

Part Number	Description	Price
T2T-4-WO	4 Wire Application + Waving Hand Logo Wave to Open	\$225.00
T2T-4-HC-WO	4 Wire Application + Handicap Logo Wave to Open	\$225.00
T2T-2-WO	2 Wire Application + Waving Hand Logo Wave to Open	\$470.00
T2T-2-HC-WO	2 Wire Application + Handicap Logo Wave to Open	\$470.00
T2T-4-WL	4 Wire Application + Waving Hand Logo Wave to Lock	\$225.00
T2T-4-HC-WL	4 Wire Application + Waving Hand Logo Wave to Lock	\$225.00
T2T-2-WL	2 Wire Application + Waving Hand Logo Wave to Lock	\$470.00
T2T-2-HC-WL	2 Wire Application + Handicap Logo Wave to Lock	\$470.00

- For existing switches having two wires only, both the RCM and TWM modules are required
- For existing switches have 4+ wires, the RCM only is required

Comes with new adhesive display plates to indicate new touch-free feature





# RCI Switches



## 910TC Series Touchless Actuators

2-15/16" W x 4-11/16" H single-gang mounts | 1-3/4" W x 4-1/2" H mullion mounts

The RCI 910TC touchless switch is designed for touchless door activation in any facility. It functions by triggering activation of automatic door openers by hand gesture or use of a remote fob. It can make the difference when it comes to a clean, hygienic facility.

### Standard Touch Free Actuators

910TC	910TC (hand), black	\$151.00
910TC-SS	910TC (hand), stainless	\$151.00
910TC-HC	910TC (wheelchair), black	\$151.00
910TC-HC-SS	910TC (wheelchair), stainless	\$151.00
910TC-REM	910TC, (hand), black	\$151.00

### Narrow Touch Free Actuators

910NTC	910TC Narrow, (hand), black	\$151.00
910NTC-SS	910TC Narrow, (hand), stainless	\$151.00
910NTC-HC	910TC Narrow, (wheelchair), black	\$151.00
910NTC-HC-SS	910TC Narrow, (wheelchair), stainless	\$151.00

### Touch Free Actuator Kits (includes remote + transmitter)

910NTC-REM	910TC Narrow, (hand), black + remote & transmitter	\$276.00
910NTC-SS-REM	910TC Narrow, stainless + remote & transmitter	\$276.00
910NTC-HC-REM	910TC Narrow, (wheelchair), black + remote & transmitter	\$276.00
910NTC-HC-SS-REM	910TC Narrow, (wheelchair), stainless + remote & transmitter	\$276.00
910TC-SS-REM	910TC, stainless + remote & transmitter	\$276.00
910TC-HC-REM	910TC, (wheelchair), black + remote & transmitter	\$276.00
910TC-HC-SS-REM	910TC, (wheelchair), stainless + remote & transmitter	\$276.00

### Accessories

P910NTC-WRM	910NTC Narrow Receiver	\$101.00
910TC-WRB	910TC Transmitter	\$51.00
910TC-WRM	910TC Receiver	\$101.00

# RCI Switches



## 912-WBT Battery power; touch-free actuator

912-WBT: 5" x 5" x 1.75"

## 912N-WBT Battery power; touch-free actuator (narrow)

912N-WBT: 4.75" x 2" x 1.75"

## 912GL-WBT Battery power; touch-free actuator

(glass & marble surfaces)

912GL-WBT: 3.375" x 3.375" x 0.565"

### 912 Standard Touch-free Actuators

912-WBT	Single switch (waving hand icon)	\$282.00
912-WBT-R	Single switch & receiver (waving hand icon)	\$437.00
912-2WBT-R	Double switch & receiver (waving hand icon)	\$749.00
912-WBT-HC	Single switch (wheelchair icon)	\$282.00
912-WBT-R-HC	Single switch & receiver (wheelchair icon)	\$437.00
912-2WBT-R-HC	Double switch & receiver (wheelchair icon)	\$749.00

### 912 Narrow Touch-free Actuators

912N-WBT	Narrow Single switch (waving hand icon)	\$282.00
912N-WBT-R	Narrow Single switch & receiver (waving hand icon)	\$437.00
912N-2WBT-R	Narrow Double switch & receiver (waving hand icon)	\$749.00
912N-WBT-HC	Narrow Double switch (wheelchair icon)	\$282.00
912N-WBT-R-HC	Narrow Single switch & receiver (wheelchair icon)	\$437.00
912N-2WBT-R-HC	Narrow Double switch & receiver (wheelchair icon)	\$749.00

### Glass plate Touch-free Actuator (Black)

912GL-WBT	(1 switch) (waving hand icon)	\$282.00
912GL-WBT-HC	(1 switch) (wheelchair icon)	\$282.00
912GL-2WBT-R	(2 switches and 1 receiver) (waving hand icon)	\$749.00
912GL-WBT-R	(1 switch and 1 receiver) (waving hand icon)	\$437.00
912GL-2WBT-R-HC	(2 switches and 1 receiver) (wheelchair icon)	\$749.00
912GL-WBT-R-HC	(1 switch and 1 receiver) (wheelchair icon)	\$437.00

### Accessories

912-R	Receiver	\$101.00
912-R-SC	Receiver Single Channel with 2 Remotes (coming soon)	\$120.00
912-R-MC	Receiver Four Channel with 2 Remotes (coming soon)	\$138.00
912-REM-SC	Single Channel Remote (coming soon)	\$33.00
912-REM-MC	Four Channel Remote (coming soon)	\$41.00
912-WBT-SMB	Surface Mount Box	\$38.00
912N-WBT-SMB	Surface Mount Box Narrow	\$38.00

# RCI Switches



## 940 Rectangular Push Plate

2-3/4"W x 4-1/2"H (70mm x 114mm)

940 Rectangular Stainless Steel Pushplates		List Price
940H-MO x 32D	Momentary, SPDT	\$118.00
940HP-MO x 32D	Momentary, SPDT	\$118.00
940PTE-MO x 32D	Momentary, SPDT	\$118.00
940B-MO x 32D	Momentary, SPDT	\$118.00

### How To Order

Type		Switch Mode	
H	-Handicap Symbol		
HP	-Handicap Symbol + Push to Open		
PTE	-Push to Exit		
B	-Blank		
940		-	x 32D
		MO	

<sup>1</sup>Standard



## 941 Mullion Push Plate

1-1/2"W x 4-3/4"H (38mm x 121mm)

941 Mullion Push Plates		List Price
941H-MO x 32D	Narrow, Momentary Handicap Logo Only	\$96.00
941P-MO x 32D	Narrow, Momentary PTO	\$96.00
941HP-MO x 32D	Narrow, Momentary Handicap PTO	\$96.00
941HPMICRO x 32D	Narrow, Momentary, Handicap PTO with Microswitch Door Switch	\$96.00
941HMICRO x 32D	Narrow, Momentary, Handicap with Microswitch Door Switch	\$96.00
BLU Finish		N/C

### How To Order

Type		Finish	
P	-Push To Open		
H	-Handicap Symbol		
HP	-Handicap Symbol + Push To Open	32D	-Brushed Stainless Steel Finish
B	-Blank <sup>1</sup>	BLU	-Blue
941		-	MO x
		MICRO	-Micro-Switch <sup>2</sup>

<sup>1</sup>Available only in 32D finish

<sup>2</sup>Available only with HP and H type in 32D finish

# RCI Switches



## 9LP36 Low Profile Push Plate

6"W x 36"H (152mm x 915mm)

### 9LP36 36" Pushplate for Low Profile Solutions **List Price**

9LP36-HW x 32D	36" Low Profile Push Bar - Hard Wired Installation Only	\$879.00
9LP36-433	36" Low Profile Push Bar - Plate Includes 433 MHz Transmitter - Wireless Installation	\$954.00

#### How To Order

		Type	
9LP36	-	HW	-For Hardwire Installation
		433	-For Wireless Installation (433MHz Transmitter)
	x	32D	



## 9RCT433/ 9DRCR433 Transmitters & Receivers

2-3/4"W x 2-1/8"H x 1"D  
(70mm x 55mm x 14mm)

433 MHz Transmitters & Receivers			List Price
9RCT4331	433 MHz One-Button Handheld, 3" x 2" x 1"		\$81.00
9RCT4332	433 MHz Two-Button Handheld, 3" x 2" x 1"		\$104.00
9RCT4333	433 MHz Three-Button Handheld, 3" x 2" x 1"		\$104.00
9RCT4334	Four-Button Handheld, 3" x 2" x 1"		\$104.00
9RCT4333V1	One-Button Wired with 3 Volt Battery - Not Compatible with 10BOXJAMBST, 3" x 2" x 1"		\$97.00
9RCT4339V1	One-Button Wired with 9 Volt Battery - Not Compatible with 10BOXJAMBST, 3" x 2" x 1"		\$81.00
9DRCR433VB	433 MHz Digital Receiver with Integrated Vestibule Sequencing, 3" x 2" x 1"		\$99.00
9DRCR433EHT	433 MHz Digital Receiver with Extended Hold Time, 3" x 2" x 1"		\$99.00

#### How To Order Transmitter

9RCT433		
	1	-One Button
	2	-Two Buttons
	3	-Three Buttons
	4	-Four Buttons
	3V1	-One Button Wired With 3V Battery
	9V1	-One Button Wired With 9V Battery Lead
<b>Type</b>		

#### How To Order Receiver

9DRCR433		
	VB	-Receiver
	EHT	-Receiver With Extended Hold Time
<b>Type</b>		

# RCI Switches

## Options & Accessories

<b>940/941 Options</b>		<b>List Price</b>
P94/5DMO	DPDT Momentary Switch	\$63.00
940SUR	Surface Mount Box (940P/940HP) Brown	\$50.00
941SUR	Surface Style Mount Box - Compatible with 10TD-433PB3V	\$25.00
941FLU	Flush Style Mount Box - Compatible with 10TD433PB3V	\$25.00
95045FLU	Round Flush Style Mounting Box	\$70.00

<b>950 Options</b>		<b>List Price</b>
P94/5DMO	DPDT Momentary Switch	\$63.00
950ESC45	Stainless Steel Escutcheon (950P45/950HP45)	\$223.00
950ESC6	Stainless Steel Escutcheon (950P6/950HP6)	\$223.00
9506SUR	Round Surface Style Mounting Box	\$68.00
9506FLU	Round Flush Style Mounting Box	\$71.00
946DGPLATE	Back Plate Required for Double Gang Electrical Box (4.75")	\$26.00
9464PLAST	Plastic Mounting Box	\$26.00

<b>970 Options</b>		<b>List Price</b>
97AUD	Audible Alert Mounted On Same Plate As Button	\$121.00
97MO	2-SPST Momentary Switch	\$68.00
97MA	2-SPST Maintained Switch	\$68.00
97DMO	4-SPST (2-SPST N.O. 2-SPST N.C.) Momentary Switch	\$99.00
97DMA	4-SPST (2-SPST N.O. 2-SPST N.C.) Maintained Switch	\$99.00
97Y	Yellow Push Button Cap Color	\$20.00
97G	Green Push Button Cap Color	\$20.00
97W	White Push Button Cap Color	\$20.00
97R	Red Push Button Cap Color	\$20.00
9RECBOX	Recessed Box 4-1/8"H x 2-1/2"W x 1-3/4"D	\$35.00

<b>946/947 Options</b>		<b>List Price</b>
94645SUR	Square Surface Mounting Box (4.5")	\$68.00
94645DGSUR	Double Gang Surface Mounting Box (4.5")	\$68.00
946475SUR	Square Surface Mounting Box (4.75")	\$68.00
946475FLU	Square Flush Style Mounting Box (4.75")	\$68.00
946475WR	Weather Ring for Box (4.75")	\$18.00
9466SUR	Square Surface Mounting Box (6")	\$67.00
9466FLU	Flush Style Mount Box (6")	\$68.00
946DGPLATE	Back Plate Required for Double Gang Electrical Box (4.75")	\$26.00
9464PLAST	Plastic Mounting Box	\$26.00

<b>960 Options</b>		<b>List Price</b>
96CYL-KA	Straight Cam Mortise 1-1/4" (Keyed Alike, 2 Keys)	\$41.00
96CYL-KD	Straight Cam Mortise 1-1/4" (Keyed Different, 2 Keys)	\$41.00
96DMO	DPDT Momentary Switch for Second Position	\$74.00
96DMA	DPDT Maintained Switch for Second Position	\$74.00
96LED	LED Option (Bi-Color - Red/Green)	\$12.00
96MO	SPDT Momentary Switch for Second Position	\$45.00
96MA	SPDT Maintained Switch for Second Position	\$45.00
9RECBOX	Recessed Box 4-1/8"H x 2-1/2"W x 1-3/4"D	\$35.00

<b>9 Series</b>	<b>Mushroom pushbutton accessories</b>	<b>List Price</b>
TD30	30 Sec. Fixed Timer (12/24VDC)	\$105.00
TD30A	0 To 30 Sec. Adjustable Relock Timer (12/24VDC)	\$105.00

# RCI Power Transfers and Door Contacts

## 9500/9501 Mortise Pin Transfers

1/2" W x 2-3/4" H (13mm x 71mm)

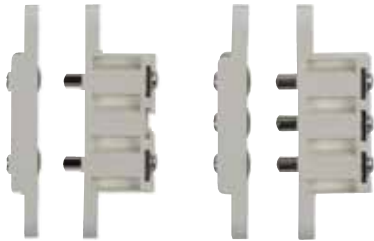

**9500**  
2 Pin

**9501**  
3 Pin

### How To Order

Type	
0	-2 Pin Contact
1	-3 Pin Contact

950

## 9507/9509 Flex Loops



### How To Order

Type	Finish
Standard — 7	Silver <sup>1</sup> — S
Heavy-Duty — 9	Brown — B
	White — W
950	-
7" (178mm) — 7	
12" (305mm) — 12	
18" (457mm) — 18	
24" (610mm) — 24	
36" (914mm) — 36	

### Length

<sup>1</sup>9509 available in Silver only

9500/9501 Mortise Pin Transfers	List Price
9500 2 PIN Mortise Transfer 1.5A @ 24VAC, white finish	\$128.00
9501 3 PIN Mortise Transfer 1.5A @ 24VAC, white finish	\$229.00

Current Transfers - 9507 Flex Loops	List Price
9507-7 7" Door Loop	\$26.00
9507-12 12" Door Loop	\$33.00
9507-18 18" Door Loop	\$37.00
9507-24 24" Door Loop	\$42.00
9507-36 36" Door Loop	\$54.00



## 9520/9521/9522 9523/9524 Electrified Hinges

- 9520** 4" x 4" (102mm x 102mm)
- 9521** 4-1/2" x 4" (114mm x 102mm)
- 9522** 4-1/2" x 4-1/2" (114mm x 114mm)
- 9523** 5" x 4-1/2" (127mm x 114mm)
- 9524** 5" x 5" (127 mm x 127mm)

Current Transfers - 9507 Flex Loops	List Price
95206 2 + 4 Wire 4" x 4" Hinge x 5 Knuckle x 4' Lead x 26D	\$245.00
95216 2 + 4 Wire 4-1/2" x 4" Hinge x 5 Knuckle x 4' Lead x 26D	\$245.00
95226 2 + 4 Wire 4-1/2" x 4-1/2" Hinge x 5 Knuckle x 4' Lead x 26D	\$245.00
95236 2 + 4 Wire 4-1/2" x 5" Hinge x 5 Knuckle x 4' Lead x 26D	\$267.00
95246 2 + 4 Wire 5" x 5" Hinge x 5 Knuckle x 4' Lead x 26D	\$290.00
95209 2 + 4 Wire 4" x 4" Hinge x 5 Knuckle x 4' Lead x 32D	\$304.00
95219 2 + 4 Wire 4-1/2" x 4" Hinge x 5 Knuckle x 4' Lead x 32D	\$304.00
95229 2 + 4 Wire 4-1/2" x 4-1/2" Hinge x 5 Knuckle x 4' Lead x 32D	\$304.00
95239 2 + 4 Wire 4-1/2" x 5" Hinge x 5 Knuckle x 4' Lead x 32D	\$324.00
95249 2 + 4 Wire 5" x 5" Hinge x 5 Knuckle x 4' Lead x 32D	\$347.00

Current Transfers - 9509 Flex Loops	List Price
9509-7S 7" Heavy Duty Door Loop	\$37.00
9509-12S 12" Heavy Duty Door Loop	\$42.00
9509-18S 18" Heavy Duty Door Loop	\$49.00
9509-24S 24" Heavy Duty Door Loop	\$54.00
9509-36S 36" Heavy Duty Door Loop	\$70.00

### How To Order

#### Size

0	-4" x 4" (102mm x 102mm)
1	-4-1/2" x 4" (114mm x 102mm)
2	-4-1/2" x 4-1/2" (114mm x 114mm)
3	-5" x 4-1/2" (127mm x 114mm)
4	-5" x 5" (127 mm x 127mm)

952	x	
	Brushed Chrome —	26D
	Brushed Stainless Steel —	32D

#### Finish

# RCI Power Transfers and Door Contacts



## 9512/9513 Bridge Cables

**9512** Visible face: 1"W x 12-3/4"H (25mm x 324mm)  
Recessed: 7/8"W x 10-3/16"H (23mm x 259mm)

**9513** Visible face: 1"W x 21-7/16"H (25mm x 545mm)  
Recessed: 7/8"W x 18-7/8"H (23mm x 479mm)

### How To Order

		Type	
	2	-12-3/4" H (324mm)	
	3	-21-7/16" H (545mm)	
951		x	26

Current Transfers - Bridge Cables		List Price
9512	Bridge Cable 11-1/2" (10-3/16") x 1"	\$104.00
9513	Bridge Cable 20-1/16" (18-3/4") x 1"	\$166.00



## 9530 Balanced Magnetic Contact/Door Position Switch

### How To Order

9530

3-1/2" W x 1-1/4" H x 5/8" D  
(89mm x 32mm x 16mm)

Door Position Switches		List Price
9530	Balanced magnetic contact	\$292.00



## 9540 Recessed Magnetic Contact/Door Position Switch

3/4"W x 3/4"H x 7/8"D  
(19mm x 19mm x 22mm)

### How To Order

9540	x	
White	-	W
Black	-	B
<b>Finish</b>		

Door Position Switches		List Price
9540 x W	Recessed magnetic contact, white	\$33.00
9540 x B	Recessed magnetic contact, black	\$33.00

# Locksets

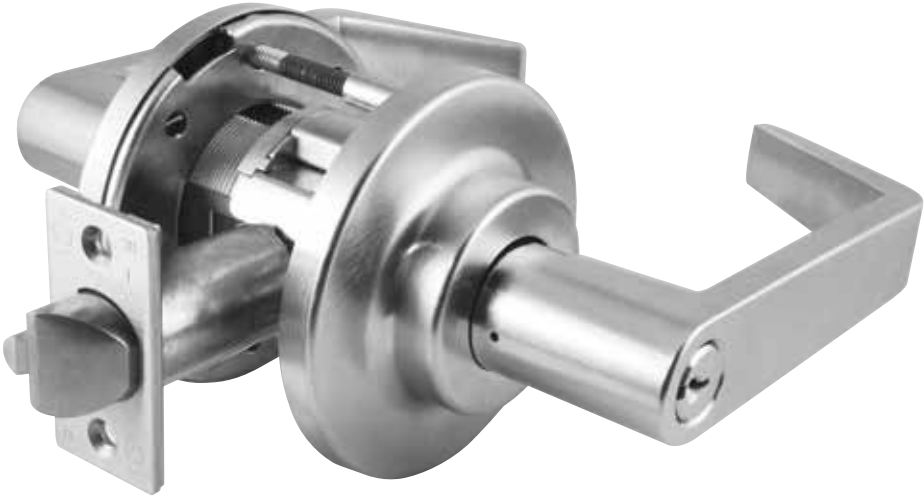



# RCI Locksets

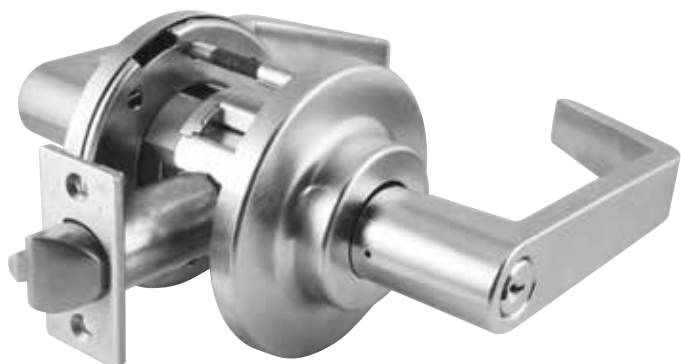

## C800 Series Grade 1 Heavy-Duty Cylindrical Locksets

Provides exceptional security, enhanced aesthetics and rugged dependability.

C800 Locksets		List Price
C880ELDLRE6265	Storeroom, electrically locked (fail-safe), 12VDC	\$486.00
C880ELDLRE6268	Storeroom, electrically locked (fail-safe), 24VDC	\$486.00
C880ELRXDLRE6265	Storeroom, electrically locked (fail-safe), 12VDC, with request-to-exit	\$555.00
C880ELRXDLRE6268	Storeroom, electrically locked (fail-safe), 24VDC, with request-to-exit	\$555.00
C880EUDLRE6265	Storeroom, electrically unlocked (fail-secure), 12VDC	\$486.00
C880EUDLRE6268	Storeroom, electrically unlocked (fail-secure), 24VDC	\$486.00
C880EURXDLRE6265	Storeroom, electrically unlocked (fail-secure), 12VDC, with request-to-exit	\$555.00
C880EURXDLRE6268	Storeroom, electrically unlocked (fail-secure), 24VDC, with request-to-exit	\$555.00

### How To Order

Function		Cylinder Type <sup>1</sup>	Finish <sup>2</sup>	Latch Bolts <sup>5</sup>			Strike Options	Lip Length	Keying Options <sup>5</sup>
Fail-Secure	Fail-Safe			AM	Antimicrobial Coating <sup>3</sup>	Security Screws			
80EU	80EL	S -Sargent 10 Line KIL (less cylinder) D -Conventional Cylinder L -Less Cylinder C -SFIC J -Less SFIC T -Temporary SFIC R -Schlage FSIC (less core)	626 -Satin Chrome (Standard) 625 -Bright Chrome 619PVD -Satin Nickel 613PVD -Dark Oxidized Satin Bronze 612PVD -Satin Bronze 606PVD -Satin Brass 605PVD -Bright Brass				5001	1316	
C8									
Request to Exit	RX	LR C -3-1/2" Dia. LC D -3-1/2" Dia. stamped, LOCK LG E -3-1/2" Dia. stepped rose LT F -3-1/2" Dia. stepped rose stamped, LOCK LF <sup>6</sup> LV <sup>6</sup>	5 -12VDC 8 -24VDC	TX Security Screws	RH LH	134 138	-1-3/4" -2-1/4" -1-3/8" -1-5/8"		
		<b>Rose Design</b>	<b>Voltage</b>		<b>Door Hand<sup>4</sup></b>		<b>Door Thickness<sup>4</sup></b>		
		<b>Lever<sup>5</sup></b>							

<sup>1</sup>Consult factory for other cylinder options.

<sup>2</sup>For split finishes, consult factory. Specify hand.

<sup>3</sup>Available on 626 finish only. Consult factory for other finishes.

<sup>4</sup>Door Thickness Range: 1-3/4" -2-1/4" without spacers, 1-3/8" - 1-5/8" with spacers.

<sup>5</sup>See next page for options

<sup>6</sup>Specify handing when ordering LF or LV levers

**NOTE:** Consult factory for lead times on other options

# RCI Locksets

## Latch Bolts

Latch Throw	Backset	Latch Type	Face
3/4" Throw Latch	18	5	-All Other Functions
1/2" Throw Latch	10	0	-C810, C840, C844
2-3/8" Backset	1	0	-1" Face, Square Corner
2-3/4" Backset	2	1	-1" Face, 1/4" Radius Corner
3-3/4" Backset	3	2	-1-1/8" Face, Square Corner
5" Backset	5		

## Keying Options

### Standard Keyways

Keyway	Keying
OBIT	-0-Bitted -Construction Master Keyed
CMK	-Master Keyed
MKD	-Master Keyed
NSK	-Non-Stock Keyed
KA4	-Keyed Alike, Sets of 4
KA2	-Keyed Alike, Sets of 2
KD	-Keyed Different
SC	-Schlage C
SE	-Schlage E
D100	-DORMA SKC
CA	-Corbin 60
CD	-Corbin 59A1
CE	-CorbinRusswin L4
RA	-Russwin 981
RB	-Russwin D1
GA	-Sargent LA
SF	-Schlage F
WA	-Weiser E
YA	-Yale 8
YG	-Yale GA

Retrofit Keyways Available  
0-Bitted Only

### IC Keyways

Keyway	Keying
TMP	-Temporary Construction Core
MKD	-Combinated (Master Keyed)
BA	-Best A
BB	-Best B
BC	-Best C
BD	-Best D
BE	-Best E
BF	-Best F
BG	-Best G
BH	-Best H
BJ	-Best J
BK	-Best K
BL	-Best L
BM	-Best M
BQ	-Best Q
D100	-DORMA SKC (7-pin Core Only)
BLK	-Black Construction Core
BLU	-Blue Construction Core
GRN	-Green Construction Core

Specify color if required to match existing project

## Lever Designs

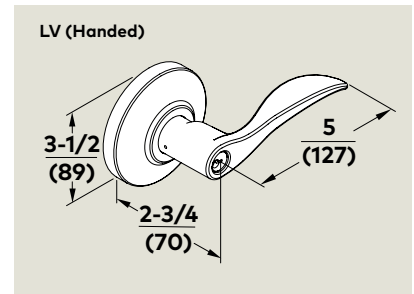
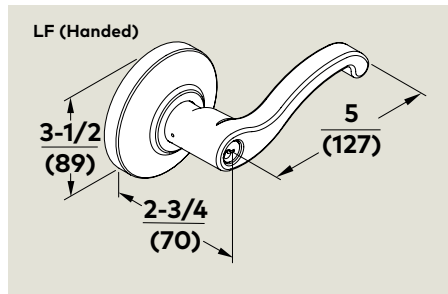
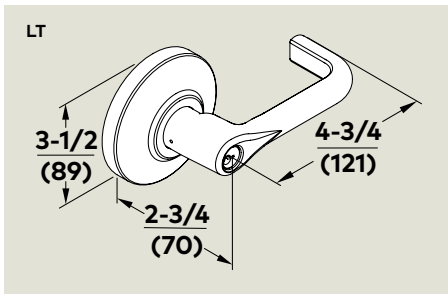
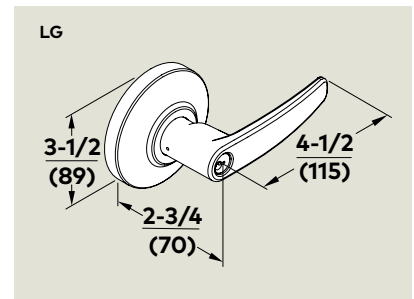
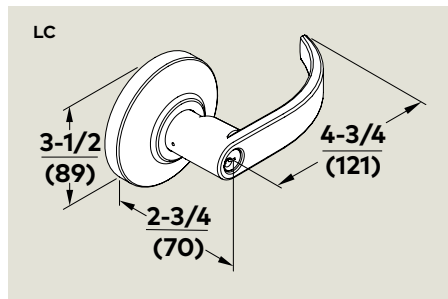
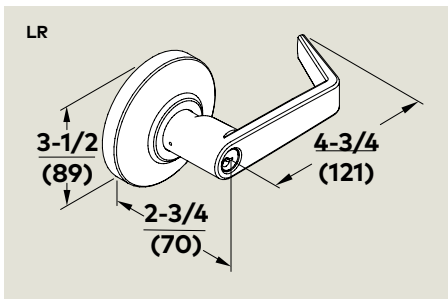

# Specialty Locksets



# RCI Specialty Locks

---



## YG80 Electronic heavy-duty door lock

5.9" (150mm) x 3.15" (80mm) x 2.36" (60mm)

High-strength lock designed for securing gates, roll-up doors, shipping containers, and other large doors or entryways. Offers the ability to integrate into an access control system. Fully monitored, weatherproof, and user configurable, the YG80 is the perfect indoor and outdoor locking solution.

<b>YG80 Electronic heavy-duty door lock</b>		<b>List Price</b>
YG80	Extreme duty electronic roll-up door lock	\$993.00

# RCI Specialty Locks



## 3590 Lock 'N' Prox

Battery powered lock with built-in proximity reader – ideal standalone solution.

2-3/8" W x 2-3/8" H x 7/8" D (60mm x 60mm x 22mm)

Dimensions of lock only. Excludes pin.

Lock 'N' Prox Battery Powered Lock	List Price
3590SPCRD - Battery Powered Cabinet Lock 'n' Prox - Straight Locking Pin - 1 Prog. Card & 2 User Cards	\$473.00
3590SPFOB - Battery Powered Cabinet Lock 'n' Prox - Straight Locking Pin - 1 Prog. Card & 2 User Fobs	\$473.00
3590SPACRD - Battery Powered Cabinet Lock 'n' Prox - Straight Locking Pin w/ Alarm - 1 Prog. Card & 2 User Cards	\$523.00
3590SPAFOB - Battery Powered Cabinet Lock 'n' Prox - Straight Locking Pin w/ Alarm - 1 Prog. Card & 2 User Fobs	\$523.00
3590RACRD - Battery Powered Cabinet Lock 'n' Prox - Right-angle Locking Pin - 1 Prog. Card & 2 User Cards	\$473.00
3590RAFOB - Battery Powered Cabinet Lock 'n' Prox - Right-angle Locking Pin - 1 Prog. Card & 2 User Fobs	\$473.00
3590RAACRD - Battery Powered Cabinet Lock 'n' Prox - Right-angle Locking Pin w/ Alarm - 1 Prog. Card & 2 User Cards	\$523.00
3590RAA-FOB - Battery Powered Cabinet Lock 'n' Prox - Locking Pin W/Alarm - 1 Prog. Card & 2 User Fobs	\$523.00

### How To Order

		Options	
		A	- Alarm Function
3590			
Straight Pin-	SP	CRD	-Proximity Cards – 2 pack
Right-Angle Spring Loaded Pin-	RA	FOB	-Proximity Fobs – 2 pack
<b>Locking Pin</b>		<b>Credentials</b>	

Example: **3590SPAFOB**

### Accessories

Model	Description	List Price
3590LP-ALM	Straight Locking Pin	\$78.00
3590LP-ZALSP	Right-angle Locking Pin	\$92.00
3590PX-CRD10	User Cards - 10 Pack	\$199.00
3590PX-FOB10	User Fobs - 10 Pack	\$199.00
3590ER-SLOC	External Reader - Surface Mounted	\$53.00
3590ER-RLOC	External Reader - Recess Mounted	\$53.00
3590PX-PRO	Replacement programming card	\$78.00

# RCI Specialty Locks



## 3510LM Electromechanical Cabinet Lock

Compact, surface-mounted design ideal for small enclosures.  
 1-5/8" W x 1-7/8" H x 13/16" D (42mm x 48mm x 20mm)  
 Dimensions of lock only. Excludes pin.

Electric Cabinet Lock for Small Enclosures		List Price
3510LM	Electric Cabinet Lock with Latch Monitor	\$145.00

**How To Order**

3510 LM



## 3513 Electromechanical Cabinet Lock

Compact, surface-mounted design ideal for small enclosures.  
 1-3/16" W x 2-7/8" H x 1-1/8" D (30mm x 73mm x 29mm)  
 Dimensions of lock only. Excludes pin.

## 3513DM Electromechanical Cabinet Lock with Monitoring

Compact, surface-mounted design ideal for small enclosures.  
 1-3/16" W x 2-7/8" H x 1-1/8" D (30mm x 73mm x 29mm)  
 Dimensions of lock only. Excludes pin.

Electric Cabinet Lock for Small Enclosures		List Price
3513	Field Selectable Electromechanical Cabinet Lock 12 or 24VDC Black	\$144.00
3513DMB	Field Selectable Cabinet Lock with Dual Monitoring 12/24VDC Black	\$201.00
3512TTAB	Catch for 3513/3513DM	\$18.00

**How To Order**

3513  DM -Dual Monitoring  
**Options**

# RCI Specialty Locks



RCI 3525



RCI 3525iCL

## 3525 Electromechanical Rack Handle Lock Series

Provides intelligent electronic locking and monitoring capabilities. Available with built in 125kHz prox reader; 13.56MHz iClass reader or dual 125kHz and 13.56 MHz reader.

Electronic Rack Handle (Includes 3 keys - Keyed Alike)		List Price
3525	Electronic Rack Handle 12VDC to 24VDC x Black	\$603.00
3525PRX	Electro-Mechanical Rack Handle Lock with Proximity Reader	\$731.00
3525iCL	Electro-Mechanical Rack Handle Lock with iCLASS Reader	\$731.00
3525DFR	Electro-Mechanical Rack Handle Lock with Dual Frequency Reader	\$845.00

### Accessories

Model	Description	List Price
<b>Cams</b>		
3525-GR3815	0.61" (15.5mm) grip cam, 1-1/2" (38mm) length	\$6.30
3525-GR3817	0.69" (17.5mm) grip cam, 1-1/2" (38mm) length	\$6.30
3525-GR3819	0.77" (19.5mm) grip cam, 1-1/2" (38mm) length	\$6.30
3525-GR3821	0.85" (21.5mm) grip cam, 1-1/2" (38mm) length	\$6.30
3525-GR3823	0.93" (23.5mm) grip cam, 1-1/2" (38mm) length	\$6.30
3525-GR4522	0.77" (19.5mm) grip cam, 1-3/4" (45mm) length	\$6.30
3525-GR4524	0.85" (21.5mm) grip cam, 1-3/4" (45mm) length	\$6.30
3525-GR4526	0.93" (23.5mm) grip cam, 1-3/4" (45mm) length	\$6.30
<b>Gearbox For Multi-Point Systems</b>		
3525-MPLH	Left Hand Gearbox (CCW to open)	\$45.00
3525-MPRH	Right Hand Gearbox (CW to open)	\$45.00
<b>Integration Kit</b>		
SSIK	Security Integration Kit	\$406.00

How to Order		
3525		Electronic Rack Handle
	PRX	125kHz Proximity Reader
	iCL	13.56MHz iCLASS Reader
	DFR	125kHz & 13.56MHz Dual Reader

RCI 3525 series will also function with a host of 125kHz credentials. Contact your representative for compatibility information.

NOTE: The lock sensor is an optical device that senses the presence of the locking cam. Keyed cylinder can affect sensing. Removal of factory installed keyed cylinder will void warranty.

### Credentials

Model	Description	List Price
PSC-1-H	Proximity Card (Clamshell) - 25 Pack	See Keypads & Readers
PSI-4-H	Proximity Card (Printable) - 25 Pack	
PSM-2P-H	Proximity Card (ISO imageable) - 25 Pack	
PSM-2S-H	Proximity Card with magnetic stripe (ISO imageable) - 25 Pack	
PSK-3-H	Proximity Fob - 25 Pack	
PDT-1-H	Proximity Tag (adhesive) - 25 Pack	
DE2-125	Dual Frequency Proximity Card (for Prox and Smart-card applications) - 25 Pack	

# RCI Specialty Locks



## MEM4400 Compact Electromechanical Lock

Ideal for sliding doors or small enclosures.  
 1-3/4"W x 1-3/16"H x 21/32"D (44mm x 30mm x 16.5mm)  
 Armature Plate: 1-3/4"W x 1-3/16"H x 1/2"D (44mm x 30mm x 12.5mm)

Mechanical Electromagnetic Lock		List Price
MEM4400	Ultra-Compact Designed Electromagnetic Lock	\$380.00

**How To Order**

MEM4400



## S2500A Mini Electromagnetic Lock

For small enclosures or hutches.  
 4-1/4"W x 1-1/2"H x 3/4"D (107mm x 37mm x 20mm)  
 Armature Plate: 2-1/2"W x 1-1/4"H x 11/32"D (44mm x 30mm x 9mm)

S2500A Mini Electromagnetic Lock		List Price
S2500A-12	Mini Electromechanical lock	\$131.00

**How To Order**

S2500A

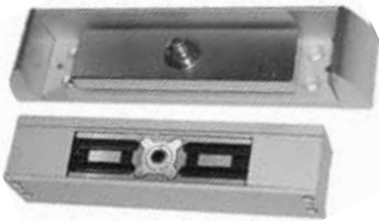

## EM-MAG1500 Compact Electromechanical Lock

For outswing doors & small enclosures.  
 6-7/32"W x 1-7/16"H x 1-3/8"D (158mm x 36mm x 35mm)  
 Armature Plate: 4-3/4"W x 1-3/16"H x 1/2"D (121mm x 30mm x 12.5mm)

Mechanical Electromagnetic Lock		List Price
EM-MAG1500	Slim-line Electromagnetic Lock for Narrow Profile Door Frames	\$356.00

**How To Order**

EM-MAG1500



## MEM2400 Compact Electromechanical Lock

For inswing doors & small enclosures.  
 8-5/8"W x 1-7/16"H x 1-3/8"D (218mm x 36mm x 35mm)  
 Armature Plate: 7-1/8"W x 1-3/16"H x 1/2"D (181mm x 30mm x 12.5mm)

Mechanical Electromagnetic Lock		List Price
MEM2400	Slim-line Electromagnetic Lock with Early Warning Detectors	\$363.00

**How To Order**

MEM2400





# Notes

---

# Power Supplies



# RCI Power Supplies



## DKPS-2A

The dormakaba DKPS-2A power supply/charger is designed to convert 120-240 VAC, 50 or 60Hz into a continuous 2 Amp supply at 12 or 24VDC power outputs (switch selectable).  
FPDB standard (Fire Panel Disconnect Board)

Model	Power Supply	List Price
DKPS-2A	2 amp power supply - 12/24VDC @2.5 amps	\$439.00



## DKPS-4A

The dormakaba DKPS-4A power supply/charger is designed to convert 120-240 VAC, 50 or 60Hz into a continuous 4 Amp supply at 12 or 24VDC power outputs (switch selectable).  
FPDB standard (Fire Panel Disconnect Board)

Model	Power Supply	List Price
DKPS-4A	4 amp power supply - 12/24VDC @4 amps	\$586.00



## DKPS-6A

The dormakaba DKPS-6A power supply/charger is designed to convert 120-240 VAC, 50 or 60Hz into a continuous 6 Amp supply at 12 or 24VDC power outputs (switch selectable).  
FPDB standard (Fire Panel Disconnect Board)

Model	Power Supply	List Price
DKPS-6A	6 amp power supply - 12/24VDC @6 amps	\$846.00

# RCI Power Supplies Accessories



## DKPS-TSW1 Tamper Switch

The **tamper switch** is a device that is designed to connect to the DKPS Power Supply. When installed, it signals a warning to authorized personnel if the metal enclosure has been removed from the wall and/or the door is not fully closed or secured.

How to Order			List Price
DKPS	- TSW1 - 02	Tamper switch for DKPS power supply enclosure door	\$2000

**NOTES:** Tamper switch is recommended but is required when the entire access control installation must meet UL294 Edition 6 or higher.



## DKPS-TSW2 Tamper Switch

The **tamper switch** is a device that is designed to connect to the DKPS Power Supply. When installed, it signals a warning to authorized personnel if the metal enclosure has been removed from the wall and/or the door is not fully closed or secured.

How to Order			List Price
DKPS	- TSW2 - 02	Tamper switch for DKPS power supplies (enclosure door & installation)	\$26.00

**NOTES:** Tamper switch is recommended but is required when the entire access control installation must meet UL294 Edition 6 or higher.



## WPDT Wireless Power & Data Transfer

1" (25mm) x 4.13" (104mm) x 1.88" (47mm)

Transfers low voltage power and data signals without the use of hard wires. WPDT offers an innovative and less intrusive way of wirelessly transferring low voltage power and data signals between a door and frame.

How to Order		List Price
WPDT	Wireless power and data transfer	\$522.00

# RCI Power Supplies Accessories

## TD365 Day Timer

3-3/4"W x 4-11/16"H x 1"D (95mm x 120mm x 25mm)



Options		List Price
TD365	365 Day Timer	\$182.00
24-12CONV	Converter Board 24-12VDC	\$99.00

Accessories		List Price
TD1	Delayed Unlock - Manual Relock	\$182.00
TD2	Delayed Unlock - Auto Relock	\$99.00
TD3	Instant Unlock - Delayed Auto Relock	\$101.00
TD4	3 Sec Nuisance Delay - Manual Relock	\$135.00
BB12-4	4AH Battery Backup (1) 12VDC	\$41.00
BB12-7	7AH Battery Backup (1) 12VDC	\$57.00
BB24-4	4AH Battery Backup (2) 24VDC	\$94.00
BB24-7	7AH Battery Backup (2) 24VDC	\$111.00
9310RB	Relay Board 12/24VDC-10 Amp	\$79.00



## 9310RB Relay Board

2" x 1 9/16" x 3/4" (50 x 40 x 19mm)

Versatile and reliable board with input-output terminals designed to control low voltage supply.

- 12/24 Selectable
- Large screw terminals for ease of wire connection
- LED indicators
- SPDT output
- 10A Rated
- 2 year warranty

Model	Description	List Price
SPTD	Relay Board	\$26.00



## RB-DPDT8A Relay Board

2 1/2" x 2" x 3/4" (62 x 54 x 19mm)

Versatile and reliable board with input-output terminals designed to control low voltage supply.

- 12/24 Auto Sensing
- Large screw terminals for ease of wire connection
- LED indicators
- DPDT output
- 8A Rated
- 2 year warranty

Model	Description	List Price
DPTD	Relay Board	\$31.00

# RCI Power Supplies Accessories



NOTE: T1002 shown



NOTE: T1005 shown

## AC Plug-In Transformers

2-1/4"W x 3-3/16"H x 2"D (57mm x 81mm x 51mm)

Model	Description	Output Voltage / Power	List Price
T1002	Plug-In Transformer CSA to UL 1310	12VAC-20VA	\$41.00
T1004	Plug-In Transformer CSA to UL 1310	16VAC-20VA	\$51.00
T1008	Plug-In Transformer CSA to UL 1310	24VAC-20VA	\$50.00

## AC Wire-In Transformers

T1001: 2-1/4"W x 2"H x 2"D (57mm x 51mm x 51mm)  
 T1005 and T1009: 2-1/4"W x 2"H x 2-1/4"D (57mm x 51mm x 57mm)

Model	Description	Output Voltage / Power	List Price
T1001	Wire-In/UL Transformer	12VAC-20VA	\$42.00
T1005	Wire-In Transformer CSA to UL 1585	16.5VAC-37VA	\$40.00
T1009	Wire-In Transformer CSA to UL 1585	24VAC-40VA	\$50.00



## DC Plug-In Power Supply

1-5/8"W x 3"H x 1-3/8"D (41mm x 76mm x 35mm)

Model	Description	Output Voltage / Power	List Price
T1003	Plug-In/UL Power Supply	12VDC-1.5A	\$69.00



## Bridge Rectifiers

10R1, 10R1-6: 3/16"D x 3/8"Dia. (4.75mm x 9.5mm)  
 10R3, 10R3-6: 1/4"D x 5/8" Sq. (6.4mm x 16mm)

Model	Description	Output Voltage / Power	List Price
10R1	Rectifier	1A	\$6.50
10R1-6	Rectifier with 6" leads	1A	\$24.00
10R3	Rectifier	3A	\$12.00
10R3-6	Rectifier with 6" lead	3A	\$28.00

# Door Controllers & Peripherals



# Door Controllers & Peripherals



## Keyscan LUNA™ SDACSKT Single Door Access Control Smart Kit

The combination of AC unit, one reader, 10 credentials, power supply and comprehensive software, brings affordable access control security, accountability, and reporting to small businesses for a fraction of the cost of other comparable systems.

Keyscan LUNA™ Single Door Access Control Smart Kit		List Price
SDACSKT	Single door access control smart kit	\$1,268.00

## K-SMART3 13.56MHz Reader Series Keyscan Smartcard BLE Reader

This Keyscan BLE-ready smartcard reader is a 13.56 high frequency reader that offers users the convenience of using smartcards and the new K-BLE mobile credentials. It features additional support for a built-in "heartbeat" that monitors the reader communication advising end-users if any type of optional reader tamper or if the reader cable is cut. May not work with non-Keyscan access panels without purchase of optional K-PC2 programming card to disable enhanced features. Suitable for indoor and outdoor applications. Keyscan ACU requires System Firmware V 9.39 or higher for enhanced feature.

Keyscan 13.56MHz Reader Series Keyscan Smartcard BLE Reader		List Price
K-SMART3	Keyscan Smartcard BLE Reader	\$389.00



# Door Controllers & Peripherals



## K-SECURE Ten Pack 1K ISO Contactless Smartcard

The Keyscan K-SECURE 1K Series of printable (ISO) style of Contactless Smartcard is equipped with numerous anti-counterfeiting and card anti-duplication technologies and a robust AES multilayer encryption technology offering greater security. K-SECURE 1K complies with international interoperability (ISO14443) standards for 3rd party applications and is ISO printable. They are available in Keyscan 36-bit format for even more security over standard 26-bit 125kHz credentials which can be duplicated.

Keyscan Ten Pack - 1K ISO Contactless Secure Smartcard		List Price
K-SECURE1K10	Ten Pack - 1K ISO Contactless Secure Smartcard	\$84.00



## K-SECURE 1K 1K Contactless Smartcard

The Keyscan K-SECURE Series Contactless Smartcard is equipped with numerous anti-counterfeiting and card anti-duplication technologies and a robust AES multilayer encryption technology offering greater security. K-SECURE complies with international interoperability (ISO14443) standards for 3rd party applications and is ISO printable. They are available in Keyscan 36-bit format for even more security over standard 26-bit 125kHz credentials which can be duplicated. Also available in 4K memory.

Keyscan Mifare 1K Contactless Secure Smartcard		List Price
K-SECURE 1K	1K Contactless Secure Smartcard	\$358.00 (pk of 50)

# Door Controllers & Peripherals

---



## K-SMART Reader Programming Card

Optional reader read range programming cards may be presented to a properly installed, powered and functioning K-SMART3 reader after power up. Card will toggle the BLE read range settings to one of 4 settings - short, medium, long and maximum. Not required for default BLE operation on K-SMART3 readers. Works with all Keyscan default K-SMART3 site key readers.

Keyscan K-SMART3 Reader Programming Card		List Price
BLE1	K-SMART3 Programming Card	\$35.00



## K-SF-1K Keyscan Smart Fob 1K

The Keyscan K-SECURE series Smart Fob offers the same functionality and high security of the K-SECURE contactless smartcard. It includes the same numerous anti-counterfeiting and anti-duplication technologies as well as the robust AES multi-layer encryption technology offering greater security. Keyscan smart Fob complies with international interoperability (ISO14443) standards for 3rd party applications. They are available in Keyscan 36-bit format for even more security. It is the ideal credential alternative to traditional card credentials.

Keyscan Smart Fob 1K		List Price
K-SF-1K	Keyscan Smart Fob 1K	\$682.00 (pk of 50)

# Door Controllers & Peripherals



## SDRA Keyscan LUNA SDAC Replacement Antenna

Your Keyscan LUNA SDAC communicates via Wi-Fi through an antenna. This replacement SDAC antenna is approved and guaranteed to function with your Keyscan LUNA SDAC. Any other antenna purchased from any source may cause damage, unintended results or may not functional at all and will void your SDAC warranty.

Keyscan LUNA SDAC Replacement Antenna		List Price
SDRA	Keyscan LUNA SDAC Replacement Antenna	\$32.00



## PS1225 Replacement Plug-in 12VDC Transformer

The PS1225 is a replacement 12VDC plug-in switching transformer for the SDACSKT (SDAC Kit). Plugs into standard 120 Vac outlet and provides up to 2.5 amps. Has 60" of 18 Gauge cable for mounting close to SDAC control. Has 2.1 mm barrel power connector. Center positive. For replacement of transformer provided in the SDACSKT.

C/UL/US Listed  
Black Colour

Replacement Plug-in 12VDC Transformer		List Price
PS1225	12VDC Transformer	\$62.00

# Notes

---

# Exit Devices



# RCI Exit Devices

---



## 120 Series Exit Bar

Non-latching exit bar.  
2-1/2"H x 3-5/8"D (63.5mm x 92mm)

Model	Description	For Door Widths	Finish 28	Finish 40
120A-SS1	Non-latching exit bar with SPDT switch	24–36" (610–914mm)	\$447.00	\$476.00
L120A-SS1	Non-latching exit bar with SPDT switch	37–48" (940–1219mm)	\$516.00	\$571.00
120A-SS2	Non-latching exit bar with 2SPDT switch	24–36" (610–914mm)	\$481.00	\$506.00
L120A-SS2	Non-latching exit bar with 2SPDT switch	37–48" (940–1219mm)	\$559.00	\$607.00
120D-SS1	Non-latching exit bar with SPDT switch and camlock dogging	24–36" (610–914mm)	\$476.00	\$502.00
L120D-SS1	Non-latching exit bar with SPDT switch and camlock dogging	37–48" (940–1219mm)	\$545.00	\$581.00
120D-SS2	Non-latching exit bar with 2SPDT switch and camlock dogging	24–36" (610–914mm)	\$518.00	\$532.00
L120D-SS2	Non-latching exit bar with 2SPDT switch and camlock dogging	37–48" (940–1219mm)	\$601.00	\$629.00

**RCI Exit Devices are not available for the foreseeable future.**

**Please contact Customer Service for information on DORMA or PRECISION alternatives. We apologize for any inconvenience.**

# RCI Exit Devices



## 1200 Series Mechanical Rim Exit Bar

Interlocking latch design.  
2-1/2"H x 3-5/8"D (63.5mm x 92mm)

Model	Description	For Door Widths	28 Finish	40 Finish
1200A	Mechanical rim exit bar, no dogging	24-36" (610-914mm)	\$479.00	\$512.00
L1200A	Mechanical rim exit bar, no dogging	37-48" (940-1219mm)	\$554.00	\$613.00
1200C*	Mechanical rim exit bar cylindrical dogging exit device	24-36" (610-914mm)	\$525.00	\$559.00
L1200C*	Mechanical rim exit bar cylindrical dogging exit device	37-48" (940-1219mm)	\$601.00	\$661.00
1200D	Mechanical rim exit bar cam dogging exit device	24-36" (610-914mm)	\$479.00	\$512.00
L1200D	Mechanical rim exit bar cam dogging exit device	37-48" (940-1219mm)	\$554.00	\$613.00
1200F	Mechanical rim exit bar fire exit device	24-36" (610-914mm)	\$525.00	\$559.00
L1200F	Mechanical rim exit bar fire exit device	37-48" (940-1219mm)	\$601.00	\$661.00
1210A	Mechanical rim exit bar no dogging, alarm module (9V battery)	32-36" (813-914mm)	\$661.00	\$708.00
L1210A	Mechanical rim exit bar no dogging, alarm module (9V battery)	37-48" (940-1219mm)	\$735.00	\$811.00
1210D	Mechanical rim exit bar, camlock dogging, alarm module (9V battery)	32-36" (813-914mm)	\$685.00	\$749.00
L1210D	Mechanical rim exit bar, camlock dogging, alarm module (9V battery)	37-48" (940-1219mm)	\$759.00	\$834.00
1210F	Mechanical rim exit bar, fire doors, alarm module (9V battery)	32-36" (813-914mm)	\$685.00	\$749.00
L1210F	Mechanical rim exit bar, fire doors, alarm module (9V battery)	37-48" (940-1219mm)	\$759.00	\$834.00
1220A	Mechanical rim exit bar, alarm module (12-24VDC remote, 9V battery backup)	32-36" (813-914mm)	\$867.00	\$900.00
L1220A	Mechanical rim exit bar, alarm module (12-24VDC remote, 9V battery backup)	37-48" (940-1219mm)	\$941.00	\$1,002.00
1220D	Mechanical rim exit bar, camlock dogging, alarm module (12-24VDC remote, 9V battery backup)	32-36" (813-914mm)	\$890.00	\$928.00
L1220D	Mechanical rim exit bar, camlock dogging, alarm module (12-24VDC remote, 9V battery backup)	37-48" (940-1219mm)	\$966.00	\$1,025.00
1220F	Mechanical rim exit bar for fire doors, alarm module (12-24VDC remote, 9V battery backup)	32-36" (813-914mm)	\$890.00	\$928.00
L1220F	Mechanical rim exit bar for fire doors, alarm module (12-24VDC remote, 9V battery backup)	37-48" (940-1219mm)	\$966.00	\$1,025.00
1230A	Mechanical rim exit bar, with alarm module (12-24VDC remote)	32-36" (813-914mm)	\$661.00	\$708.00
L1230A	Mechanical rim exit bar, with alarm module (12-24VDC remote)	37-48" (940-1219mm)	\$735.00	\$811.00
1230D	Mechanical rim exit bar, camlock dogging, alarm module (12-24VDC remote)	32-36" (813-914mm)	\$685.00	\$749.00
L1230D	Mechanical rim exit bar, camlock dogging, alarm module (12-24VDC remote)	37-48" (940-1219mm)	\$759.00	\$834.00
1230F	Mechanical rim exit bar for fire doors, alarm module (12-24VDC remote)	32-36" (813-914mm)	\$685.00	\$749.00
L1230F	Mechanical rim exit bar for fire doors, alarm module (12-24VDC remote)	37-48" (940-1219mm)	\$759.00	\$834.00

**NOTES:** Models with A,C or D Suffix: cULus Listed Panic Hardware, ANSI/BHMA A156.3-2001, Grade 1 Models with F Suffix: cULus Fire Exit Hardware rated 3-hours, ANSI/BHMA A156.3, Grade 1 Conforms to ANSI/UL10C and UBC 7-2 (1997) Alarm cylinder not included.

Options for 1200 Series	List Price
SS1A-10/20/30	Signal Switch Models, Alarm Module SPDT \$184.00
SS2A-10/20/30	Signal Switch Models, Alarm Module 2SPDT \$194.00
LMS	Lock Monitor Switch \$186.00

**RCI Exit Devices are not available for the foreseeable future.**

**Please contact Customer Service for information on DORMA or PRECISION alternatives. We apologize for any inconvenience.**

# RCI Exit Devices



## 1300 Series Electrified Rim Exit Bar

Interlocking latch design.  
2-1/2"H x 3-5/8"D (63.5mm x 92mm)

Model	Description	For Door Widths	28 Finish	40 Finish
1300A	Electrified rim exit bar, no dogging	24-36" (610-914mm)	\$860.00	\$886.00
L1300A	Electrified rim exit bar, no dogging	37-48" (940-1219mm)	\$938.00	\$986.00
1300C*	Electrified rim exit bar, cylindrical dogging	24-36" (610-914mm)	\$909.00	\$970.00
L1300C*	Electrified rim exit bar, cylindrical dogging	37-48" (940-1219mm)	\$986.00	\$1,037.00
1300D	Electrified rim exit bar, camlock dogging	24-36" (610-914mm)	\$860.00	\$886.00
L1300D	Electrified rim exit bar, camlock dogging	37-48" (940-1219mm)	\$938.00	\$986.00
1300F	Electrified rim exit bar for fire doors	24-36" (610-914mm)	\$909.00	\$938.00
L1300F	Electrified rim exit bar for fire doors	37-48" (940-1219mm)	\$986.00	\$986.00
1310A	Electrified rim exit bar, no dogging, alarm module (9V battery)	32-36" (813-914mm)	\$1,045.00	\$1,061.00
L1310A	Electrified rim exit bar, no dogging, alarm module (9V battery)	37-48" (940-1219mm)	\$1,113.00	\$1,164.00
1310D	Electrified rim exit bar, camlock dogging, alarm module (9V battery)	32-36" (813-914mm)	\$1,086.00	\$1,113.00
L1310D	Electrified rim exit bar, camlock dogging, alarm module (9V battery)	37-48" (940-1219mm)	\$1,164.00	\$1,213.00
1310F	Electrified rim exit bar for fire doors, alarm module (9V battery)	32-36" (813-914mm)	\$1,069.00	\$1,098.00
L1310F	Electrified rim exit bar for fire doors, alarm module (9V battery)	37-48" (940-1219mm)	\$1,139.00	\$1,188.00
1320A	Electrified rim exit bar, alarm module (12-24VDC remote, 9V battery backup)	32-36" (813-914mm)	\$1,241.00	\$1,263.00
L1320A	Electrified rim exit bar, alarm module (12-24VDC remote, 9V battery backup)	37-48" (940-1219mm)	\$1,316.00	\$1,363.00
1320D	Electrified rim exit bar, camlock dogging, alarm module (12-24VDC remote, 9V battery backup)	32-36" (813-914mm)	\$1,289.00	\$1,316.00
L1320D	Electrified rim exit bar, camlock dogging, alarm module (12-24VDC remote, 9V battery backup)	37-48" (940-1219mm)	\$1,363.00	\$1,415.00
1320F	Electrified rim exit bar, fire doors, alarm module (12-24VDC remote, 9V battery backup)	32-36" (813-914mm)	\$1,263.00	\$1,290.00
L1320F	Electrified rim exit bar, fire doors, alarm module (12-24VDC remote, 9V battery backup)	37-48" (940-1219mm)	\$1,339.00	\$1,389.00
1330A	Electrified rim exit bar, with alarm module (12-24VDC remote)	32-36" (813-914mm)	\$1,047.00	\$1,075.00
L1330A	Electrified rim exit bar, with alarm module (12-24VDC remote)	37-48" (940-1219mm)	\$977.00	\$1,164.00
1330D	Electrified rim exit bar, camlock dogging (12-24VDC remote)	32-36" (813-914mm)	\$1,086.00	\$1,113.00
L1330D	Electrified rim exit bar, camlock dogging (12-24VDC remote)	37-48" (940-1219mm)	\$1,164.00	\$1,213.00
1330F	Electrified rim exit bar for fire doors, alarm module (12-24VDC remote)	32-36" (813-914mm)	\$1,069.00	\$1,098.00
L1330F	Electrified rim exit bar for fire doors, alarm module (12-24VDC remote)	37-48" (940-1219mm)	\$1,139.00	\$1,188.00

**NOTES:** Models with A,C or D Suffix: cULus Listed Panic Hardware, ANSI/BHMA A156.3-2001, Grade 1 Models with F Suffix: cULus Fire Exit Hardware rated 3-hours, ANSI/BHMA A156.3, Grade 1 Conforms to ANSI/UL10C and UBC 7-2 (1997) Alarm cylinder not included.

Options for 1300 Series	List Price
SS1A-10/20/30	Signal Switch Models, Alarm Module SPDT \$194.00
SS2A-10/20/30	Signal Switch Models, Alarm Module 2SPDT \$204.00
LMS	Lock Monitor Switch \$196.00

**RCI Exit Devices are not available for the foreseeable future.**

**Please contact Customer Service for information on DORMA or PRECISION alternatives. We apologize for any inconvenience.**



**How To Order**

			Signal Switch 2SPDT, Alarm Models – 10/20/30	SS2A			
			Signal Switch SPDT, Alarm Models – 10/20/30	SS1A			
			Signal Switch 2SPDT weather-proof –	SS2W			
			Signal Switch SPDT weather-proof –	SS1W			
Mechanical –	12		Signal Switch 2SPDT –	SS2		Brushed Anodized Aluminum –	28
Electrified –	13		Signal Switch SPDT –	SS1		Brushed Anodized Dark Bronze –	40
			-		-	x	
L	Long – Bar 37-48"	00A	– No Dogging		LMS	– Lock Monitor Switch	
		00C*	– Cylindrical Dogging				
		00D	– Cam Dogging				
		00F	– Fire Rated				
		10A	– No Dogging, Alarm (9V Battery)				
		10D	– Camlock Dogging, Alarm (9V Battery)				
		10F	– Fire Rated, Alarm (9V Battery)				
		20A	– Alarm (12-24VDC Remote, 9V Battery Backup)				
		20D	– Camlock Dogging, Alarm (12-24VDC Remote, 9V Battery Backup)				
		20F	– Fire Rated, Alarm (12-24VDC Remote, 9V Battery Backup)				
		30A	– Alarm (12-24VDC Remote)				
		30D	– Camlock Dogging, Alarm (12-24VDC Remote)				
		30F	– Fire Rated, Alarm (12-24VDC Remote)				

**RCI Exit Devices are not available for the foreseeable future.**

**Please contact Customer Service for information on DORMA or PRECISION alternatives. We apologize for any inconvenience.**

# RCI Exit Devices



## Exterior Trims

For 1200/1300 rim exit devices.

- Electrified option available
- UL certified ANSI/BHMA 156.3, Grade 1
- UL certified for fire doors

Exterior Trims for 1200/1300 Exit Devices		28 Finish
02P-LTD	Escutcheon with pull – thru-bolt mounted 1-15/16"W	\$101.00
03C-LTD	Escutcheon only – cutout for cylinder 1-7/8"W, thru-bolt mounted	\$78.00
03P-LTD	Escutcheon with pull – cutout for cylinder 1-15/16"W, thru-bolt mounted	\$114.00
08-L	Lever – field selectable handing LH/RH, cutout for cylinder, thru-bolt mounted 1-13/16"W, Std. LHR, field reversible to RHR	\$314.00
08N-L	Lever narrow – cutout for cylinder, for 2-1/8" stile, thru-bolt mounted 1-13/16"W, specify handing	\$314.00
08-EL	Electrified lever – field selectable handing LH/RH, cutout for cylinder, thru-bolt mounted 1-13/16"W, Std. LHR, field reversible to RHR, 24VDC standard (12VDC optional)	\$530.00
08N-EL	Electrified lever narrow – cutout for cylinder, for 2-1/8" stile, thru-bolt mounted 1-13/16"W, specify handing, 24VDC standard (12VDC optional)	\$530.00
40 finish	Add	\$24.00

**NOTE:** Cylinders not supplied with trim.

Accessories for 1200 and 1300 Series		List Price
DDS	Double door strike, black oxide finish	\$108.00
SS1	Signal switch SPDT	\$114.00
SS2	Signal switch 2SPDT	\$143.00
SS1W	Signal switch SPDT weather-proof with mounting hardware	\$191.00
SS2W	Signal Switch, 2SPDT, Weatherproof	\$191.00

**RCI Exit Devices are not available for the foreseeable future.**

**Please contact Customer Service for information on DORMA or PRECISION alternatives. We apologize for any inconvenience.**

# Terms & Conditions

---

1. Acceptance. The following Terms and Conditions of sale are applicable to all Quotations, Contract, Purchase Orders, Order Acknowledgement Forms, and sales of Seller's services and products, and are the only applicable terms and conditions thereto, except for terms establishing prices, quantities, delivery schedules, terms of payment, invoicing, shipping instructions, and the identification of the products associated with each transaction. If any conflict exists between the Terms and Conditions and a Quotation, Purchase Order, Order Acknowledgment form, or sale, these Terms and Conditions shall prevail BY REQUESTING A QUOTATION OF ORDERING ANY PRODUCTS OR SERVICES FROM SELLER, BUYER AGREES TO ALL THE FOLLOWING TERMS AND CONDITIONS. If a written contract signed by both parties is in existence covering the sale of the goods and services, the terms and conditions of the contract shall control to the extent they are inconsistent with these Terms and Conditions.

1. Order Procedure. Buyer may or may not request the preparation of a Quotation prior to ordering any products or services from Seller. Buyer then shall place a Purchase Order with Seller. By placing a Purchase Order, Buyer makes an offer to purchase products or services from Seller pursuant to these Terms and Conditions. Seller, in its discretion, may accept or reject the Purchase Order. If Seller accepts the Purchase Order, Seller shall issue an Order Acknowledgement Form confirming Buyer's order. No Purchase Order is binding on Seller unless accepted by Seller as provided in these Terms and Conditions.

2. Quotations. All Quotations by Seller are subject to change or withdrawal without prior notice to Buyer unless otherwise specifically stated in the Quotation. Quotation prices are valid on Purchase Orders placed within 90 days of the quote being issued, unless otherwise specifically stated in the quotation. If no order is placed within the stated time frame, prices may be adjusted to reflect the then-current published prices, surcharges, escalators, or other pricing adjustment due to, among other things, costs of materials, labor, transportation, taxes, duties, and other cost increases to Seller. All resulting Purchase Orders become effective only if and when approved and accepted in writing by Seller by the issuance of its Order Acknowledgement Form. Seller reserves the right to discontinue manufacture of any products or change products materials, design, or specifications without notice.

Quotation prices are valid on Purchase Orders placed within 90 days of the quote being issued, unless otherwise specifically stated in this quotation. If no order is placed within the stated time frame, prices may be adjusted to reflect the then-current published prices, surcharges, escalators, or other pricing adjustment due to, among other things, costs of materials, labor, transportation, taxes, duties, and other cost increases to Seller. All resulting Purchase Orders become effective only if and when approved and accepted in writing by Seller by the issuance of its Order Acknowledgement Form. All Quotations and resulting orders are subject to Seller's Terms and Conditions set forth in the price book.

3. Site Requirements.

a. The Quotation is contingent upon all work being performed during normal business hours unless otherwise negotiated and a mutually agreeable schedule. The Quotation is calculated on one continuous installation engagement based on acceptable site conditions where other dependent scopes have completed preparation for proposed materials (i.e. electrical work, floor work, adjacent construction). When Buyer has given authorization for work to begin, no other scopes may impede Seller's ability to complete installation in agreed upon area. Seller reserves the right

to invoice for costs that are incurred due to unacceptable site conditions or delays by others resulting in additional installation visits.

b. Signed acceptance by Buyer of shop drawings and/or submittals shall be interpreted as acceptance that proposed scope is the correct interpretation of construction documents. Any field verification and/or work required by others as detailed in the submittal will be provided and coordinated by Buyer. Work shall not begin nor shall orders be placed for any projects until all shop drawings and submittals have been approved in writing by Buyer.

4. Warranty. Seller warrants only that all products sold pursuant to a Quotation or Purchase Order will conform to the description in the Price Book and will be free from defects in workmanship and materials. The duration of each product warranty is dependent on the particular product. Refer to EAD & DHW warranty statement. Extended warranties may be available for an additional cost. Seller is not responsible for defects or damages caused by wear and tear, consumable materials, vandalism, fires, storms, floods, acts of God, misuse, abuse or alteration by any company other than Seller. Seller further warrants that Buyer will receive good and valid title to the products. Any claim on account of nonconforming or defective products or for any other cause whatsoever shall conclusively be deemed waived by Buyer unless written notice thereof is given to Seller promptly after discovery but no later than sixty (60) days from date of shipment. Seller shall have the right either to replace or repair any nonconforming or defective products, to refund the purchase price upon return of the products, or to grant a reasonable allowance on account of such nonconformance or defect Seller's liability and Buyer's exclusive remedy for nonconforming or defective products shall be limited solely to replacement, repair, refund, or allowance as Seller may elect. Seller shall be given reasonable opportunity to investigate all claims and no materials shall be returned to Seller until after inspection and approval by Seller and receipt by Buyer of written shipping instructions from Seller. Buyer acknowledges and agrees that the remedies set forth in this paragraph are Buyer's exclusive remedies for the delivery of nonconforming or defective products.

#### Additional Warranties

- a) No credit will be provided for any work completed by others during warranty term.
- b) Warranty work will be performed during normal business hours with our standard response times. Any warranty work taking place beyond normal business hours or with expedited response time may be billable.
- c) Products repaired or replaced under the warranty are warranted only through the remainder of the original warranty period.

DISCLAIMER OF FURTHER WARRANTIES. EXCEPT AS SET FORTH ABOVE, THERE IS NO WARRANTY, REPRESENTATION, OR CONDITION OF ANY KIND, EXPRESS OR IMPLIED (INCLUDING NO WARRANTY OF MERCHANTABILITY OR FITNESS OF THE PRODUCTS FOR ANY USE CONTEMPLATED BY BUYER) CONCERNING SELLER'S PRODUCTS OR SERVICES AND NONE SHALL BE IMPLIED BY LAW.

5. LIMITATION OF LIABILITY AND REMEDIES. SELLER SHALL NOT BE LIABLE, AND BUYER WAIVES ALL CLAIMS AGAINST SELLER FOR ANY INCIDENTAL, CONSEQUENTIAL, OR SPECIAL DAMAGES, INCLUDING WITHOUT LIMITATION, LOST REVENUES AND PROFITS EVEN IF SELLER HAS BEEN ADVISED OF THE POSSIBILITY OF SUCH DAMAGES. BUYER'S EXCLUSIVE REMEDY FOR ANY CAUSE OF ACTION UNDER THESE TERMS AND CONDITIONS IS A CLAIM FOR DAMAGES AND IN

NO EVENT WILL DAMAGES OR ANY OTHER RECOVERY OF ANY KIND AGAINST SELLER EXCEED THE PURCHASE PRICE OF THE SPECIFIC PRODUCTS OR SERVICES AS TO WHICH THE CLAIM IS MADE. SELLER WILL NOT BE LIABLE TO BUYER FOR ANY LOSS, DAMAGE, OR INJURY TO PERSONS OR PROPERTY RESULTING FROM THE HANDLING, STORAGE, TRANSPORTATION, RESALE, OR USE OF THE PRODUCTS IN MANUFACTURING PROCESSES, OR IN COMBINATION WITH OTHER SUBSTANCES, OR OTHERWISE.

6. Intellectual Property Indemnification. (a) Seller agrees to defend, indemnify and hold Buyer harmless against any claims, costs, damages, liability and expenses resulting from actual or alleged patent, trademark, or copyright infringement, misappropriation of confidential information, or violation of any other intellectual property right, domestic or foreign, in the selling or use of any part or product that is owned by Seller and that pertains to the subject matter of a Quotation, Purchase Order, or sale of products or services (provided that the product is not modified in anyway by Buyer or any other party, and that the product is used in the manner intended by Seller). If a suit or claim results in any injunction or any other order that would prevent Seller from supplying any product falling under a Quotation, Purchase Order, or sale, or if the result of such a suit or claim would, in the reasonable opinion of Seller, otherwise cause Seller to be unable to supply such products, Seller shall have the right, at its option, if it so chooses, to do one or more of the following: (i) secure an appropriate license to permit Seller to continue supplying the products to Buyer; (ii) modify the relevant product so that it becomes non-infringing, provided that any modification does not cause any material change to the operation or performance of the product; or (iii) replace the relevant product with a non-infringing but practically equivalent product. (b) Buyer agrees to defend, indemnify, and hold Seller harmless against any claims, costs, damages, liability and expenses resulting from actual or alleged patent, trademark, or copyright infringement, misappropriation of confidential information, or violation of any other intellectual property right, domestic or foreign, in the making, using or selling of any product or using any process that is owned by Buyer or is designed or specified by Buyer and that pertains to the subject matter of a Quotation, Purchase Order, or sale.

7. Ownership of Inventions. All drawings, know-how, designs, confidential information, and the like disclosed to Buyer by Seller and all rights therein will remain the property of Seller. Buyer shall have no claim to, ownership interest in, no license to, or no rights to any information provided or communicated by Seller.

8. Lead Times. If applicable, lead times are based on standard requirements by factory to provide materials proposed. Ship dates will be provided as estimate only once order is placed with the factory. Adequate packaging will be provided for any normal shipping circumstance such that materials will be protected and labeled as required. Special packaging may be provided for an additional expense. Shipping will be cost effective unless expedited fees are accepted by Buyer. If materials are to be provided to job site or Buyer location, Seller will make an informed decision as to the best instruction to provide the shipping company. If materials are not required to have direct delivery, materials will be brought to branch for pickup by Buyer. All freight terms shall be FOB. Any claims for damage in transit or lost freight, receiving, and inspection of materials is the responsibility of Buyer. It is a requirement of Buyer to inspect and review all materials prior to accepting shipment.

9. Title/Risk of Loss. All products shall be shipped FOB Seller's manufacturing facility to Buyer's designated delivery location. Unless otherwise agreed by the parties, Seller shall select the method of and carrier for the products. Seller reserves the right to ship items in a single or in multiple shipments. Title and risk of loss to products ordered passes to Buyer upon delivery of the products to the freight carrier. Unless mutually agreed upon in writing, shipping dates are approximate and are based upon prompt receipt

of all necessary information.

10. Prices. Quoted price is valid for 90 days. Seller reserve the right to revise quotations after the 90 days. All accepted Purchase Orders are subject to Seller's price in effect at time of shipment. Buyer shall be responsible for any increase in freight rates or transportation charges occurring after Seller prepared the Order Acknowledgment Form. on the Order Acknowledgment Form. Buyer shall pay to Seller in addition to the purchase price the amount of all fees, duties, licenses, and all sales, use, privilege, occupation, excise, or other taxes, federal, state, local, or foreign which Seller is required to pay or collect in connection with products or services sold to Buyer.

11. Payments. Unless otherwise agreed in writing between the parties, all Seller's invoices are payable within thirty (30) days of their date. Time is of the essence. Interest on past due amounts will be assessed at the rate of 2% per month (24% per annum), or the maximum allowable by law.

Seller reserves the right to full payment upon completion of work unless credit is pre-established. For any work requiring materials purchase or scheduling, a 50% deposit is due at time of proposal acceptance. Twenty percent (20%) of the Quotation, Purchase Order value may be billed after job award. Joint check agreements may be requested at the discretion of Seller. If payment is outstanding for any one account, work may be stopped and outstanding orders cancelled until account is restored. Should Seller require the use of collection, attorney's fees, or fees for insufficient funds, Buyer agrees that these funds will be repaid to Seller. Seller retains the right to file a lien against all or part of the property being improved. Seller reserves the right to add a 2.5% charge if invoice becomes delinquent beyond terms.

12. Cancellation. In the event a Buyer's Purchase Order and the issuance of an Order Acceptance Form is cancelled, it will be subject to standard 35% restocking fees, cancellation fees, engineering fees, materials & freight costs incurred, and administrative fees. Standard cancellation is 20% of order as long as no materials have been ordered. Should Buyer release material orders, Buyer will be liable for that portion of the job and 20% of the remaining amount of work unperformed/unordered.

13. Storage. If applicable, Seller reserves the right to implement a storage fee if delivery is delayed after agreed upon date. Should project timeline require storage of materials, Seller reserves the right to bill for those materials at the time they have been received at a Seller location, Buyer location, or at job site. Certificate of insurance for stored materials can be provided to Buyer upon request. Signed acceptance by Buyer of shop drawings and/or submittals shall be interpreted as acceptance that proposed scope is the correct interpretation of construction documents. Any field verification and/or work required by others as detailed in the submittal will be provided and coordinated by Buyer.

14. Insolvency. Seller may, at any time or times, suspend performance of any order or require payment in cash, security, or other adequate assurance satisfactory to Seller when, in Seller's opinion, the financial condition of Buyer or other grounds for insecurity, including the filing of a petition for bankruptcy, warrant such action.

15. Force Majeure. Seller shall not be liable for any delay in fulfilling any order due to (a) fires, floods, strikes, or other labor disputes, accidents to machinery, acts of sabotage, riots, precedence or priorities granted at the request or for the benefit, directly or indirectly, of the federal or any state government or any subdivision or agency thereof, delays in transportation or lack of transportation facilities, restrictions imposed by federal or state legislation or rules of regulations thereunder; or (b) any cause beyond the control of Seller.

16. Ownership of Equipment. Unless otherwise agreed in a writing, all material, equipment, facilities, and special tooling, which term includes but is not limited to jigs, dies, fixtures, molds, patterns, special taps, special gauges, special test equipment, and manufacturing aids and replacements thereof, used in the manufacture of the products covered by any order shall remain the property of Seller. Any material, tooling, and equipment furnished to Seller by Buyer shall be and remain the personal property of Buyer with the title to and right of possession remaining in Buyer.

17. Confidential Information. All information furnished or made available by Seller to Buyer in connection with a transaction shall be held in confidence by Buyer. Buyer agrees not to use such information or disclose such information to others without Seller's prior written consent. The obligations of this paragraph does not apply to any information which (a) at the time of disclosure was, or thereafter becomes, generally available to the public by publication or otherwise through no breach by Buyer of any obligation herein, (b) Buyer can show by written records was in Buyer's possession prior to disclosure by the disclosing party, (c) is legally made available to Buyer by or through a third party having no direct or indirect confidentiality obligation to Seller with respect to such information, (d) was independently developed by Buyer without use of any of Seller's confidential information, or (e) is required to be disclosed pursuant to applicable law.

18. Waiver. No waiver by Seller of any of these Terms and Conditions shall be effective unless explicitly set forth in writing and signed by Seller. No failure to exercise, or delay in exercising, any rights, remedy, power, or privilege arising from these Terms and Conditions shall operate or be construed as a waiver thereof, nor shall any single or partial exercise of any right, remedy, power, or privilege hereunder preclude any other or further exercise thereof or the exercise of any other right, remedy, power or privilege.

19. Assignment. No assignment of any right or interest or delegation of any obligation or performance of Buyer under this order may be made without the prior written consent of Seller. Any attempted assignment or delegation will be wholly void and totally ineffective for all purposes.

20. Choice of Law. All sales, agreements for sale, offers to sell, proposals, acknowledgments and contracts of sale, including, but not limited to, Purchase Orders accepted by Seller, shall be considered a contract under the laws of the State of Delaware, and the rights and duties of all persons, and the construction and effect of all provisions hereof, shall be governed by and construed according to the laws of the State of Delaware.

21. Integration Clause. These Terms and Conditions constitute the entirety of terms and conditions, except as set forth in paragraph one, governing the sale and purchase of products and services sold by Seller. No modification of these Terms and Conditions shall be of any force or effect unless in writing and signed Seller and Buyer. Buyer may desire to utilize its own form of acknowledgment or acceptance of these Terms and Conditions. However, the use of any such form shall be for convenience only. No modification of these Terms and Conditions shall be affected by the acknowledgment or acceptance of purchase orders, shipping instruction forms, bills of lading or any other document containing terms or conditions at variance with or in addition to those set forth herein, all such varying or additional terms being hereby objected to and rejected by Seller and deemed to be waived by Buyer.

April 2022



Door  
Hardware



Electronic  
Access & Data



Mechanical  
Key Systems



Lodging  
Systems



Entrance  
Systems



Safe  
Locks



Service

## Our Sustainability Commitment

We are committed to fostering a sustainable development along our entire value chain in line with our economic, environmental and social responsibilities toward current and future generations.

dormakaba USA  
6161 E. 75th Street  
Indianapolis, IN 46250

T: 1 888 539 7226  
**dormakaba.us**

